

TECHNICAL REPORTS SERIES No. **359**

# Uranium Extraction Technology



INTERNATIONAL ATOMIC ENERGY AGENCY, VIENNA, 1993

The cover picture shows the in situ uranium central processing facility, Hobson Uranium Project, Everest Mineral Corporation, Karnes County, Texas, United States of America.

By courtesy of Lanmon Aerial Photography Inc., Corpus Christi, Texas.





## URANIUM EXTRACTION TECHNOLOGY

The following States are Members of the International Atomic Energy Agency:

AFGHANISTAN	GUATEMALA	PANAMA
ALBANIA	HAITI	PARAGUAY
ALGERIA	HOLY SEE	PERU
ARGENTINA	HUNGARY	PHILIPPINES
ARMENIA	ICELAND	POLAND
AUSTRALIA	INDIA	PORTUGAL
AUSTRIA	INDONESIA	QATAR
BANGLADESH	IRAN, ISLAMIC REPUBLIC OF	ROMANIA
BELARUS	IRAQ	RUSSIAN FEDERATION
BELGIUM	IRELAND	SAUDI ARABIA
BOLIVIA	ISRAEL	SENEGAL
BRAZIL	ITALY	SIERRA LEONE
BULGARIA	JAMAICA	SINGAPORE
CAMBODIA	JAPAN	SLOVAK REPUBLIC
CAMEROON	JORDAN	SLOVENIA
CANADA	KENYA	SOUTH AFRICA
CHILE	KOREA, REPUBLIC OF	SPAIN
CHINA	KUWAIT	SRI LANKA
COLOMBIA	LEBANON	SUDAN
COSTA RICA	LIBERIA	SWEDEN
COTE D'IVOIRE	LIBYAN ARAB JAMAHIRIYA	SWITZERLAND
CROATIA	LIECHTENSTEIN	SYRIAN ARAB REPUBLIC
CUBA	LUXEMBOURG	THAILAND
CYPRUS	MADAGASCAR	TUNISIA
CZECH REPUBLIC	MALAYSIA	TURKEY
DEMOCRATIC PEOPLE'S REPUBLIC OF KOREA	MALI	UGANDA
DENMARK	MAURITIUS	UKRAINE
DOMINICAN REPUBLIC	MEXICO	UNITED ARAB EMIRATES
ECUADOR	MONACO	UNITED KINGDOM OF GREAT BRITAIN AND NORTHERN
EGYPT	MONGOLIA	IRELAND
EL SALVADOR	MOROCCO	UNITED REPUBLIC OF TANZANIA
ESTONIA	MYANMAR	UNITED STATES OF AMERICA
ETHIOPIA	NAMIBIA	URUGUAY
FINLAND	NETHERLANDS	VENEZUELA
FRANCE	NEW ZEALAND	VIET NAM
GABON	NICARAGUA	YUGOSLAVIA
GERMANY	NIGER	ZAIRE
GHANA	NIGERIA	ZAMBIA
GREECE	NORWAY	ZIMBABWE
	PAKISTAN	

The Agency's Statute was approved on 23 October 1956 by the Conference on the Statute of the IAEA held at United Nations Headquarters, New York; it entered into force on 29 July 1957. The Headquarters of the Agency are situated in Vienna. Its principal objective is "to accelerate and enlarge the contribution of atomic energy to peace, health and prosperity throughout the world".

© IAEA, 1993

Permission to reproduce or translate the information contained in this publication may be obtained by writing to the International Atomic Energy Agency, Wagramerstrasse 5, P.O. Box 100, A-1400 Vienna, Austria.

Printed by the IAEA in Austria  
December 1993  
STI/DOC/10/359

TECHNICAL REPORTS SERIES No. 359

# URANIUM EXTRACTION TECHNOLOGY

INTERNATIONAL ATOMIC ENERGY AGENCY  
VIENNA, 1993

**VIC Library Cataloguing in Publication Data**

Uranium extraction technology. — Vienna : International Atomic Energy Agency, 1993.

p. ; 24 cm. — (Technical reports series, ISSN 0074-1914 ; 359)

STI/DOC/10/359

ISBN 92-0-103593-4

Includes bibliographical references.

1. In situ processing (Mining).
  2. Leaching.
  3. Solution mining.
  4. Uranium mines and mining.
- I. International Atomic Energy Agency.  
II. Series: Technical reports series (International Atomic Energy Agency) ; 359.

VICL

92-00074



## FOREWORD

In 1983 the Nuclear Energy Agency of the Organisation for Economic Co-operation and Development (OECD/NEA) and the IAEA jointly published a book on Uranium Extraction Technology. A primary objective of this report was to document the significant technological developments that took place during the 1970s.

The purpose of this present publication is to update and expand the original book. It includes background information about the principles of the unit operations used in uranium ore processing and summarizes the current state of the art. The publication also seeks to preserve the technology and the operating 'know-how' developed over the past ten years. Relatively little of this experience has been documented in recent years because technical personnel have moved to other industries as mines and mills have closed down throughout the world. Extensive references provide sources for specific technological details.

This publication is one of a series of Technical Reports on uranium ore processing that have been prepared by the Division of Nuclear Fuel Cycle and Waste Management at the IAEA. A complete list of these reports is included as an addendum.

The IAEA wishes to thank the consultants and their associates who took part in the preparation of this publication. It is primarily the work of a consultants group consisting of the following members: G.M. Ritcey (Gordon M. Ritcey and Associates, Canada), R.J. Ring (Australian Nuclear Science and Technology Organisation, Australia), M. Roche (Compagnie générale des matières nucléaires, France) and S. Ajuria (Instituto Nacional de Investigaciones Nucleares, Mexico). Components of several chapters were provided by other contributors. The IAEA is also grateful to the Member States and individual organizations for their generous support in providing experts to assist in this work. The IAEA officer responsible for this work was D.C. Seidel of the Division of Nuclear Fuel Cycle and Waste Management. Mr. Seidel also participated as a technical expert and contributing author.

#### **EDITORIAL NOTE**

*The use of particular designations of countries or territories does not imply any judgement by the publisher, the IAEA, as to the legal status of such countries or territories, of their authorities and institutions or of the delimitation of their boundaries.*

*The mention of names of specific companies or products (whether or not indicated as registered) does not imply any intention to infringe proprietary rights, nor should it be construed as an endorsement or recommendation on the part of the IAEA.*

# CONTENTS

INTRODUCTION .....	1
<b>PART I. URANIUM RESOURCES AND MINING TECHNOLOGY ....</b>	<b>5</b>
CHAPTER 1. URANIUM RESOURCES .....	7
1.1. Introduction .....	7
1.2. Geological types of uranium deposits .....	7
1.3. Uranium resource classification system .....	13
1.4. Uranium resources in WOCA .....	15
References .....	18
CHAPTER 2. MINING TECHNOLOGY .....	19
2.1. Types of mining and mining practice .....	19
2.1.1. Uranium ore bodies .....	19
2.1.2. Mining recovery .....	19
2.2. Radiological and environmental aspects .....	22
2.2.1. Identification of radiological risks .....	22
2.2.2. Regulatory aspects .....	23
2.2.3. Dosimetric survey of workers .....	24
2.2.4. Radiological impact of ore mining and ore treatment on the environment .....	24
2.3. Grade control .....	26
2.3.1. General theory .....	26
2.3.2. Grade control during exploration .....	27
2.3.3. Grade control during mining .....	28
2.3.4. Grade control during ore haulage delivery to the mill .....	28
2.4. Co-ordination with mill .....	29
2.4.1. Metallurgical balance .....	30
References .....	30
<b>PART II. PROCESSING TECHNOLOGY .....</b>	<b>33</b>
CHAPTER 3. PROCESSING CONCEPTS .....	35
References .....	37

CHAPTER 4. ORE PREPARATION .....	39
4.1. Introduction .....	39
4.2. Crushing and grinding .....	39
4.2.1. Introduction .....	39
4.2.2. Comminution theory .....	40
4.2.3. Grindability .....	41
4.2.4. Circuits and equipment .....	42
4.3. Beneficiation .....	44
4.3.1. Introduction .....	44
4.3.2. Preconcentration processes .....	44
4.3.3. Radiometric sorting .....	45
4.3.4. Photometric and conductimetric sorting .....	60
4.3.5. Separation on the basis of size and shape .....	60
4.3.6. Separation on the basis of gravity .....	61
4.3.7. Separation on the basis of magnetic susceptibility .....	64
4.3.8. Flotation .....	65
4.4. Roasting .....	66
4.4.1. Introduction .....	66
4.4.2. Roasting chemistry .....	67
4.4.3. Roasting processes .....	67
4.4.4. Roasting equipment .....	69
References .....	69

CHAPTER 5. LEACHING .....	75
5.1. Introduction .....	75
5.2. Leaching chemistry .....	78
5.3. Leaching conditions and mineralogy .....	80
5.3.1. Uranium .....	81
5.3.2. Gangue minerals .....	85
5.4. Sulphuric acid leaching systems .....	89
5.4.1. Atmospheric agitation .....	89
5.4.2. Pressure leaching .....	97
5.5. Carbonate leaching systems .....	100
5.5.1. Atmospheric leaching .....	100
5.5.2. Pressure leaching .....	101
5.6. Strong acid pugging and curing .....	104
5.6.1. Somair and Cominak mills .....	104
5.7. Alternative leaching systems .....	109
5.7.1. Removal of radium and thorium .....	109

5.8.	In situ and in place leaching .....	111
5.8.1.	Introduction .....	111
5.8.2.	In situ leaching .....	113
5.8.3.	In place leaching .....	119
5.9.	Heap and vat leaching .....	121
5.9.1.	Introduction .....	121
5.9.2.	Heap leaching .....	121
5.9.3.	Vat leaching .....	127
	References .....	127
 CHAPTER 6. SOLID-LIQUID SEPARATION .....		137
6.1.	Introduction .....	137
6.2.	Concepts .....	137
6.2.1.	Thickening .....	138
6.2.2.	Filtration .....	141
6.2.3.	Flocculation .....	143
6.3.	Applications in uranium milling .....	145
6.3.1.	General circuit descriptions .....	145
6.3.2.	Solid-liquid separation equipment .....	149
	References .....	154
 CHAPTER 7. SOLUTION PURIFICATION .....		157
7.1.	Introduction .....	157
7.2.	Resin ion exchange .....	158
7.2.1.	Introduction .....	158
7.2.2.	Ion exchange chemistry and resin characteristics .....	158
7.2.3.	Ion exchange systems .....	161
7.3.	Purification by solvent extraction .....	183
7.3.1.	Introduction .....	183
7.3.2.	Extractants .....	186
7.3.3.	Modifiers .....	191
7.3.4.	Diluents .....	192
7.3.5.	Stripping .....	195
7.3.6.	Dispersion and coalescence .....	195
7.3.7.	Contacting equipment .....	196
7.3.8.	Solvent-in-pulp extraction .....	206
7.3.9.	Solvent losses .....	210
7.3.10.	Process development .....	210
7.3.11.	Materials of construction .....	214

7.3.12. Economics .....	215
7.3.13. Environmental aspects .....	215
7.4. Recovery of uranium from phosphoric acid .....	216
7.4.1. Introduction .....	216
7.4.2. Processes for uranium recovery from phosphoric acid .....	216
References .....	226

## CHAPTER 8. PRODUCT RECOVERY .....

8.1. Introduction .....	235
8.2. Product specifications .....	235
8.3. Solution characterization .....	236
8.4. Precipitation .....	237
8.4.1. Precipitation testing and evaluation .....	237
8.4.2. Direct precipitation from acidic solutions .....	238
8.4.3. Direct precipitation from alkaline solutions .....	239
8.4.4. Precipitation from acid stripping solutions .....	239
8.4.5. Precipitation from alkaline stripping solutions .....	242
8.4.6. Ammonium uranyl tricarbonate system .....	243
8.5. Solid-liquid separation .....	244
8.6. Drying or calcination .....	246
8.7. Operating practice for product recovery .....	246
8.7.1. Rabbit Lake .....	246
8.7.2. Rio Algom Panel .....	247
8.7.3. Key Lake .....	248
8.7.4. Ciudad Rodrigo .....	248
8.7.5. Cluff Lake .....	248
8.7.6. Lodève .....	248
References .....	249

## CHAPTER 9. BY-PRODUCTS .....

9.1. Introduction .....	251
9.2. Vanadium .....	251
9.3. Molybdenum .....	252
9.4. Copper .....	254
9.5. Nickel, cobalt and arsenic .....	255
9.6. Gold (and silver) .....	255
9.7. Rare earths .....	256

9.8.	Chemical salts .....	257
9.8.1.	Sodium sulphate .....	258
9.8.2.	Ammonium sulphate .....	258
	References .....	258

**PART III. WASTE MANAGEMENT AND THE ENVIRONMENT ..... 261**

**CHAPTER 10. TAILINGS MANAGEMENT TECHNOLOGY ..... 263**

10.1.	Introduction .....	263
10.2.	Tailings and waste rock characteristics .....	263
10.3.	Toxicity of effluents .....	264
10.4.	Wastewater regulations .....	264
10.5.	Design of overall treatment system .....	265
10.5.1.	Influence of the process .....	265
10.5.2.	Site selection options .....	266
10.6.	Disposal .....	267
10.7.	Water management .....	268
10.7.1.	Tailings ponds .....	269
10.7.2.	Dewatering of tailings .....	269
10.7.3.	Water recycling and reuse .....	269
10.8.	Weathering and migration .....	270
10.8.1.	Dissolution, precipitation and exchange processes .....	271
10.9.	Effluent treatment .....	271
10.10.	Decommissioning, reclamation and covers .....	272
10.11.	Monitoring of tailings impoundment sites .....	273
10.12.	Corporate responsibility and ongoing research .....	273
10.13.	The model .....	274
	Selected bibliography .....	275

**PART IV. FLOW SHEET EXAMPLES ..... 287**

**CHAPTER 11. OLYMPIC DAM ..... 289**

11.1.	Introduction .....	289
11.2.	Geology and resources .....	289
11.3.	Mineralogy .....	290
11.4.	Production capacity .....	290

11.5. Mining and milling .....	290
11.5.1. Mining .....	291
11.5.2. Copper concentrator .....	291
11.5.3. Hydrometallurgical plant .....	292
11.5.4. Copper smelter .....	296
11.5.5. Copper refinery and precious metals plant .....	297
References .....	297

<b>CHAPTER 12. KEY LAKE .....</b>	<b>299</b>
12.1. Introduction .....	299
12.2. Geology and resources .....	299
12.3. Mineralogy .....	299
12.4. Production capacity .....	300
12.5. Milling .....	300
12.5.1. Size reduction .....	300
12.5.2. Leaching and solid-liquid separation .....	302
12.5.3. Solvent extraction .....	302
12.5.4. Yellow cake precipitation and calcination .....	303
12.5.5. Ammonium sulphate crystallization plant .....	303
12.5.6. Neutralization of tailings pulp and liquids .....	303
References .....	304

<b>CHAPTER 13. RABBIT LAKE .....</b>	<b>305</b>
13.1. Introduction .....	305
13.2. Mill circuit and feed types .....	305
13.3. Flow sheet of the process .....	308
13.3.1. Ore preparation .....	308
13.3.2. Leaching .....	308
13.3.3. CCD .....	308
13.3.4. Solvent extraction .....	308
13.3.5. Impurity removal from the stripping liquor .....	309
13.3.6. Two stage precipitation .....	309
13.3.7. Calcining .....	311
13.4. Tailings management .....	311
References .....	313



CHAPTER 14. LODEVE .....	315
14.1. Introduction .....	315
14.2. Geology and resources .....	315
14.3. Mineralogy .....	315
14.4. Milling .....	316
14.4.1. Size reduction .....	318
14.4.2. Ore sorting .....	318
14.4.3. Leaching and solid-liquid separation .....	318
14.4.4. Uranium precipitation .....	319
14.4.5. Molybdenum recovery .....	319
14.4.6. Organic matter elimination .....	319
14.4.7. Sodium sulphate recovery .....	320
14.4.8. Tailings management .....	320
References .....	320
CHAPTER 15. ROSSING .....	321
15.1. Introduction .....	321
15.2. Geology and mineralogy .....	321
15.3. Mining .....	322
15.4. Milling operations .....	322
15.4.1. Crushing and grinding .....	322
15.4.2. Leaching .....	324
15.4.3. Solid-liquid separation .....	324
15.4.4. Concentration and purification .....	324
15.4.5. Product recovery .....	325
15.4.6. Tailings disposal .....	325
References .....	325
CHAPTER 16. COMINAK .....	327
16.1. Introduction .....	327
16.2. Geology .....	327
16.3. Mineralogy .....	327
16.4. Mining and milling .....	327
16.4.1. Mining .....	329
16.4.2. Size reduction .....	329
16.4.3. Leaching .....	329
16.4.4. Solid-liquid separation .....	329
16.4.5. Solvent extraction .....	330

16.4.6. Uranium recovery .....	330
16.4.7. Molybdenum recovery .....	330
16.4.8. Tailings management .....	331
References .....	331
CHAPTER 17. WHITE MESA .....	333
17.1. Introduction .....	333
17.2. Mineralogy and geology .....	333
17.3. Mill construction and operation .....	336
17.3.1. Grinding and leaching circuits .....	336
17.3.2. CCD washing circuit .....	337
17.3.3. Uranium solvent extraction and precipitation .....	337
17.3.4. Vanadium processing .....	338
17.3.5. Mill circuit features .....	338
17.4. Tailings management .....	339
Reference .....	340
CHAPTER 18. ROSITA (IN SITU LEACHING) .....	341
18.1. Introduction .....	341
18.2. Geology .....	341
18.3. Hydrology .....	345
18.4. Well field developments and restoration .....	345
18.5. Well field and process plant operations .....	351
18.6. Operational waste management .....	353
References .....	355
CONTRIBUTORS TO DRAFTING AND REVIEW .....	357

## INTRODUCTION

During the past 40 years the uranium industry has grown dramatically. This growth, however, has not been steady or predictable. Production expanded from a few hundred tonnes of uranium a year prior to 1942 to a peak WOCA (world outside centrally planned economies area) production rate of about 44 000 t U/a in the early 1980s. Since that time production has decreased significantly owing to changing demand and market conditions; in 1990 the production rate was approximately 30 000 t U/a.

Uranium ore processing technology developed rapidly, particularly during the 1950s. Significant innovations in leaching and in solid-liquid separation equipment were made. The industry pioneered hydrometallurgical applications of ion exchange and solvent extraction technologies. New techniques such as in situ leaching were also developed.

Changing demands and market conditions have played a major role in the growth and development of the uranium industry. Prior to about 1960 essentially all of the uranium produced worldwide was purchased by government agencies for military uses.

During the period from 1942 to 1945 the total annual uranium production reached a maximum of about 10 000 t U/a. Most of this was sold under contract to the United States Manhattan Project. The ores processed during this period were treated by earlier techniques developed for recovering radium from pitchblende ores or for vanadium recovery from carnotite ores. Uranium separations were achieved by the use of roasting technology or by multiple stage precipitations from leach solutions. The milling operations reflected little change from the methods that had been used 40 years earlier.

After the passage of the US Atomic Energy Act in 1946, the US Atomic Energy Commission emphasized the importance of the worldwide discovery and development of new uranium sources. In the United States of America a wide range of incentives were established: these included a guaranteed fixed price for ore, bonuses, haulage allowances, buying stations, access roads, etc. Many organizations initiated major research efforts to improve the processing technology then in use. These efforts produced improvements that led to a greater utilization of lower grade ores than had previously been considered possible. The operations included processing the uranium bearing gold ores in South Africa and developing the large low grade deposits in the Beaverlodge, Elliot Lake and Bancroft regions of Canada. Similar developments also took place in France, the former USSR and other countries.

In the late 1950s a boom in uranium demand, based on projected civil requirements, led to a remarkable amount of exploration and the construction of many new uranium mills. Some 26 facilities were operating in the USA in the period from 1960 to 1962, 19 in Canada in 1959, and many more in other countries, notably South Africa. By 1970 many of these plants were closed or on stand-by because the market

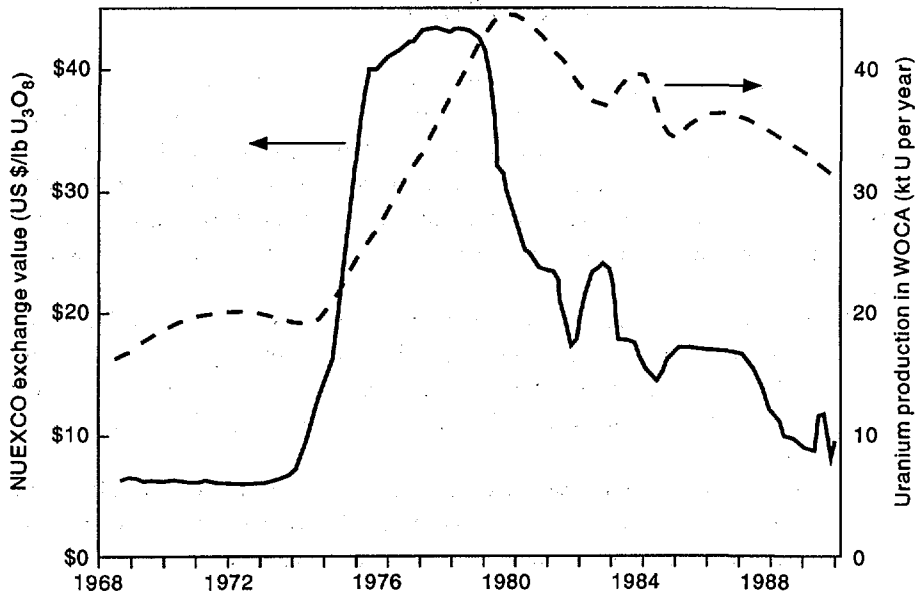

FIG. 1.1. Historical NUEXCO exchange value and uranium production in WOCA.

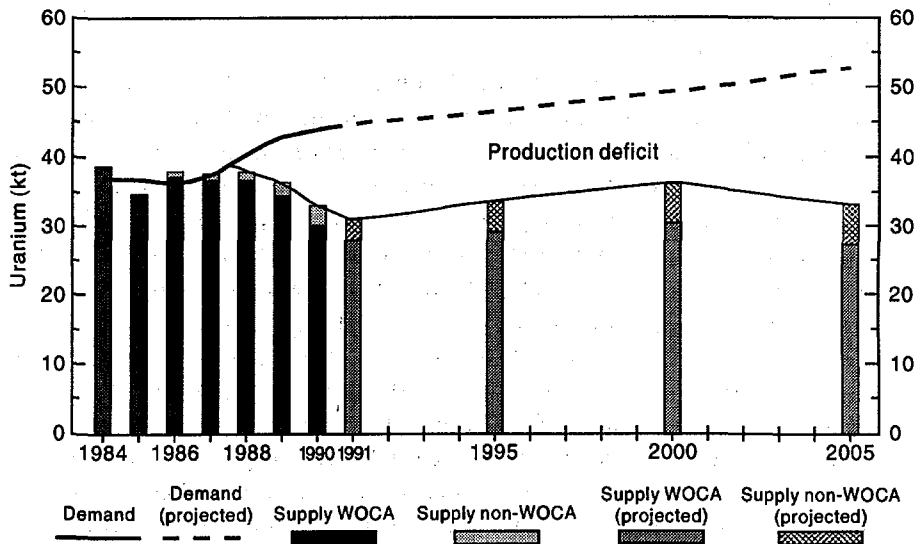

FIG. 1.2. WOCA uranium supply and demand: history and short term projection.

demand anticipated in the 1960s did not materialize. In addition, nearly all direct government procurement had ceased.

A second period of growth began in the early 1970s as more nuclear power plants were built. The projected demand for nuclear power was accelerated by the 'Energy Crisis' of the mid-1970s. The demand for uranium rose, exploration increased again, prices went up, new mines and mills were started, and old mills were refurbished. By the early 1980s a record uranium production of nearly 45 000 t U/a had been achieved.

The buoyant uranium market and the US \$40/lb (\$88/kg)  $U_3O_8$  spot prices of the late 1970s did not last. Prices started to drop in the early 1980s. Figure I.1 plots the uranium spot market prices and the uranium production for the years from 1968 to 1990. By 1990 the spot market price had dropped below \$10/lb (\$22/kg)  $U_3O_8$ . Production also dropped but at a slower rate because many mills had long term contracts at prices considerably above the spot market price. In addition, new low cost operations such as those processing the very high grade Canadian ores from Saskatchewan were coming on-stream.

Various factors, including the worldwide recession, the reduced growth of energy demand and curtailed nuclear power developments, all affected the uranium industry in the 1980s. The reduced demand and low prices again resulted in mine and mill closures, a major decline in exploration and postponement of potential new ventures throughout the world. Currently, the surviving producers are either very low cost operations, or they are still marketing their product under higher price long term contracts.

Figure I.2 shows a uranium supply-demand projection made in May 1991 for WOCA. The demand curve is based on currently operating nuclear power reactors, reactors under construction and firmly planned future commitments. The supply projection reflects production from existing and committed production centres in all parts of the world. As indicated by the curves, a production deficit has existed since about 1988. This deficit has been met from the large inventories that have been accumulated throughout the world. The exact magnitude of the worldwide inventories is not known, but available information indicates that the available WOCA inventories exceed three years of current production. It is probable that additional supplies may become available from non-WOCA inventories. The projections for a deficit indicate that additional production centres will be needed in the future. The timing for these requirements, however, is open to dispute. Estimates range from the late 1990s to well into the next century.

Throughout the world, continuing pressure is being exerted on the uranium industry to improve the environmental acceptability of uranium mining and milling. Major improvements have been made in nearly all the phases of environmental control and waste management, but there is a continuing trends toward ever more stringent regulatory requirements. The extraction of any mineral commodity has an environmental impact, and with uranium extraction there is the added complication

of residual radioactivity in the processing wastes. Each deposit has its own unique combination of geographical, chemical and radioactivity features that must be taken into account in the design, operation and decommissioning of a given uranium operation. Each production centre requires a distinctive mixture of technologies to deal with these features. Acidic drainage generated by bacterial action on sulphide minerals can be a significant problem in some operations. The presence of residual heavy metal concentrations above the regulatory specifications may give rise to the need for special treatment.

Additional and continuing research on waste management technology is one of the most important requirements of the industry.

This publication is presented in four parts as follows:

- (a) Part I presents background and summary information on uranium resources and mining technology (Chapters 1 and 2).
- (b) Part II presents extensive discussions of the uranium processing technology (Chapters 3–9). This section of the monograph includes chapters on processing concepts, ore preparation, leaching, solid-liquid separation, solution purification, product recovery and by-products. Each of these chapters includes background information about the principles of the various unit operations and summarizes the current state of the art.
- (c) Part III discusses waste management and the environment (Chapter 10).
- (d) Part IV presents descriptions and flow sheets for eight currently operating uranium production centres (Chapters 11–18). These operations represent a cross-section of the technology being used by the industry.

Throughout the publication each chapter contains an extensive list of references that provide sources for both specific and additional details about the operations being discussed.

**Part I**

**URANIUM RESOURCES  
AND  
MINING TECHNOLOGY**





# Chapter 1

## URANIUM RESOURCES

### 1.1. INTRODUCTION

As uranium resources are the base for current and future supplies, the IAEA has a long standing interest in the standardization of methodologies for assessing resources and for projecting future supplies [1.1-1.3]. In addition, the IAEA in co-operation with the Nuclear Energy Agency of the OECD, has established a uranium resource and supply database 'Uranium Resources, Production and Demand' (OECD/NEA) also referred to as the 'Red Book' [1.4], which is periodically updated.

Uranium resources have been classified with two systems: by the geological environment in which they occur, and by the degree of confidence in their existence combined with the economics of the recovery of the resource [1.4].

### 1.2. GEOLOGICAL TYPES OF URANIUM DEPOSITS

According to the geological setting, the majority of the uranium resources in the world can be assigned to one of the following types of deposits, which are arranged according to their present significance as supply sources for satisfying the WOCA reactor related uranium demand:

- (a) Unconformity related deposits,
- (b) Sandstone deposits,
- (c) Quartz pebble conglomerate deposits,
- (d) Vein deposits,
- (e) Breccia complex deposits,
- (f) Intrusive deposits,
- (g) Phosphorite deposits,
- (h) Collapse breccia pipe deposits,
- (i) Volcanic deposits,
- (j) Surficial deposits,
- (k) Metasomatite deposits,
- (l) Metamorphic deposits,
- (m) Lignite,
- (n) Black shale deposits,
- (o) Other types of deposits.

The following paragraphs describe the main features of these deposit types.

The *unconformity related deposits* occur spatially close to major erosional unconformities. Such deposits most commonly developed during a generally world-wide orogenic period that occurred about 1600 to 1800 million years ago, but also in younger geological times. Examples of this type are the deposits in northern Saskatchewan, Canada, such as Rabbit Lake (now exhausted), Cluff Lake, Key Lake, Cigar Lake and those in the Alligator River area in northern Australia (Ranger, Jabiluka). The ores of some of these deposits contain in addition to uranium other elements such as As, Ni, Mo and traces of Au.

Most of the *sandstone deposits* are contained in sedimentary rocks that were deposited under fluvial or marginal marine conditions. The host rocks are almost always relatively friable, medium to coarse grained sandstones containing pyrites and organic matter of plant origin. The sediments are commonly associated with tuffs or other volcanic material. Unoxidized ores in this type of deposit contain the uranium minerals pitchblende and coffinite. In weathered, that is oxidized, ores, secondary uranium minerals such as carnotite, tyuyamunite and uranophane are formed.

In addition to uranium, ores of the sandstone deposits can contain Mo, Se, Cu and V, which are occasionally recovered as by- or co-products.

In view of the mechanical properties of the sandstone (porosity and permeability) and the presence of underlying or overlying confining mudstones and siltstones, these deposits are often amenable to in situ leaching techniques as used in Bulgaria, the former Czechoslovakia and the USA.

Deposits of this type occur in sandstones of different geological ages and are being mined by conventional methods, for example in Argentina, France, Gabon, Niger, Pakistan, the USA and Slovenia.

Known *quartz pebble conglomerate deposits* are restricted to Lower Proterozoic rocks, which were deposited under oxygen deficient conditions. The deposits from which uranium was produced are located in the Elliot Lake district of Ontario in Canada. In the Witwatersrand basin in South Africa uranium is being recovered as a by-product of gold production. Occurrences of the quartz pebble conglomerate type are known from Brazil and India.

The uranium *vein deposits* are those in which uranium minerals, generally associated with other elements, such as Ag, Ni, Co, Bi, Fe and Mo, fill fissures, cracks, breccias etc. The dimensions of these cavities have a wide range, from the massive pitchblende veins at Jachymov, Shinkolobwe and Port Radium to the narrow cracks, faults and fissures in some of the ore bodies in France, Canada and Australia. The consequences of the geometric dimensions can be a significant dilution of the ore mined.

The *breccia complex deposits* were developed in Proterozoic continental regimes during anorogenic periods. The host rocks include quartz rich volcanoclastics and sedimentary rocks. The uranium mineralization occurs in rock sequences immediately above granitic basement complexes. The ores generally occur in both strata bound and transgressive forms. The main representative of this type of deposit

is at Roxby Downs in South Australia, where uranium occurs associated with Cu, Ag and Au.

*Intrusive deposits* include those uranium deposits that are associated with intrusive or anatectic rocks of different chemical compositions. Examples of uranium deposits include Rössing in Namibia and Palabora in South Africa, which are associated with alaskitic and carbonatitic intrusives, respectively.

The *phosphorite deposits* contain low concentrations of uranium in fine grained apatite. For the purpose of the uranium supplies, uranium in this type of deposit is considered an unconventional resource, as its recovery as a by-product is dependent upon the production of phosphoric acid. Examples of this type of deposit include the deposits in Florida, where uranium is being recovered, and the large deposits in North Africa and the Middle East.

*Collapse breccia pipe deposits* occur in circular vertical pipes filled with down dropped rock fragments. Uranium and some other elements such as Mo and Ag are concentrated in the permeable breccia filling of the pipe and in the arcuate fracture zones enclosing the pipe. Deposits of this type are mined in the Arizona Strip in the USA.

Uranium deposits of the *volcanic deposit type* are strata bound and structure bound concentrations in acid volcanic rocks. Uranium is usually associated with Mo, F, etc. Examples of this type are the deposits at Michelin in Canada, Nopal I in Chihuahua, Mexico, Macusani in Peru and numerous deposits in China and the former USSR.

Uraniferous *surficial deposits* may be broadly defined as uraniferous sediments, usually very young to recent age that have not been deeply buried and may or may not have been calcified to some degree. The uranium deposits associated with calcified sediments, referred to as calcrete, which occur in semiarid areas of Australia, Namibia and Somalia, are included within this type. Additional environments for uranium deposition, included in this type of deposit, are peats, bogs and karst caverns as well as pedogenic and structural fills.

Included among the *metasomatite deposits* are the uranium concentrations in metasomatites commonly intruded by microcline granites. Examples of this type are the deposits at Ross Adams in Alaska in the USA, which were mined in the early years of uranium production, Zheltye Vody in Krivoy Rog, in Ukraine, which is being mined, and Espinharas in Brazil.

Uranium deposits belonging to the *metamorphic deposits* generally occur in metasediments and/or metavolcanics, generally without direct evidence of post-metamorphic mineralization. One of the examples of this type is at Forstau, Austria.

Uranium in *lignites*, which is generally classified as an unconventional uranium resource, occurs in lignites and in clay and/or sandstone immediately adjacent to lignites. Examples of uraniferous lignites are located in the Serres basin, Greece, in North and South Dakota, which were mined in the past, and the deposit at Melovoe, Kazakhstan, where uranium is being recovered.

TABLE 1.1. TYPES OF URANIUM DEPOSITS AND SELECTED EXAMPLES OF ASSOCIATED ORE PROCESSING OPERATIONS

Type of uranium deposit	Main locations	Ore treatment plant (selected examples)
Unconformity related	Canada, Saskatchewan Australia, Northern Territories	Cluff Lake, Key Lake, Rabbit Lake Ranger, Nabarlek <sup>a</sup>
Sandstone	USA, Western Cordillera USA, Texas (in situ leach) USA, Nebraska (in situ leach) Niger France (siltstone) Gabon Hungary	White Mesa Rosita Crow Butte Cominak, Somair Lodev Mounana Jachymov
Quartz pebble conglomerate	Canada, Elliot Lake South Africa, Witwaterstrand	Denison, Quirke, Stanleigh <sup>a</sup> Buffelsfontein, Western Reefs, Hartebeestfontein
Vein	Canada, Northwest Territories Canada, Saskatchewan France Czechoslovakia	Port Radium <sup>a</sup> Beaverlodge <sup>a</sup> Bessines, l'Ecarpiere <sup>a</sup> Jachymov
Breccia complex	Australia, South Australia	Olympic Dam
Intrusive	Namibia USA, porphyry coppers South Africa Canada, Ontario	Rössing Bingham Canyon, Twin Butte <sup>a</sup> Palabora Bancroft <sup>a</sup>
Phosphorite	USA, Florida  North Africa and Middle Eastern countries; Estonia	International Mineral Corporation (IMC) Freeport  Sillimae
Collapse breccia pipe	USA, Arizona	White Mesa
Volcanic	Russian Federation China Mexico Brazil	Lermontov   Poços de Caldas

TABLE 1.1. (cont.)

Type of uranium deposit	Main locations	Ore treatment plant (selected examples)
Superficial (calcrete type)	Australia, Western Australia Namibia Somalia	Yeelirrie
Metasomatite	Ukraine Australia, Queensland	Zheltyye Vody Mary Kathleen <sup>a</sup>
Metamorphite	Canada, Saskatchewan Austria	
Lignite	Russian Federation USA, North Dakota China Sweden (Alum shale)	Min Kush, Tsentralnaya, Almalyk Susquehana-Western
Black shale	USA (Chatanooga shale) China	
Others	USA, New Mexico (Todilto limestone)	

<sup>a</sup> Operation now ceased.

Low concentrations of uranium and other elements occur in *black shale deposits*. Uranium in this type of deposit is also considered an unconventional resource. Examples, which were evaluated as possible uranium sources in the past, include the Kolm in Sweden and the Chattanooga shale in the USA. Other examples, which were of economic significance, are the Chanziping deposit of the 'argillaceous-carbonaceous-siliceous-pelitic rock' type in the Guangxi Autonomous Region in China and the deposit of Gera-Ronneburg in Germany.

Grouped under *other deposits* are those that cannot be classified under other headings. One example are the deposits in the Todilto Limestone, Grant's district, New Mexico, USA.

As indicated in the preceding paragraphs, uranium deposits have been found in many different locations throughout the world. Table 1.1 lists selected examples of ore processing plants that have produced uranium concentrates from the various types of uranium deposits.

	← Known resources →				← Undiscovered resources →	
OECD/NEA, IAEA	Reasonably assured		Estimated additional I		Estimated additional II	Speculative
Australia	Reasonably assured		Estimated additional I		Undiscovered	
Energy, Mines and Resources, Canada	Measured	Indicated	Inferred		Prognosticated	Speculative
France	Reserves I	Reserves II		Per- spectives I	Per- spectives II	
Germany	Proven	Probable	Possible		Prognosticated	Speculative
South Africa	Reasonably assured		Estimated additional I		Estimated additional II	Speculative
DOE, USA	Reasonably assured		Estimated additional I + II			Speculative
USBM, USGS	Identified				Undiscovered	
	Demonstrated		Inferred		Hypothetical	Speculative
Some non-WOCA countries	Measured	Indicated				
	A1	A2	B	C1	C2	P1 D
						P2

FIG. 1.1. Approximate correlations of terms used in major resource classification systems. The terms illustrated are not strictly comparable as the criteria used in the various systems are not identical. 'Grey zones' in correlation are therefore unavoidable, particularly as the resources become less assured. Nonetheless, the chart presents a reasonable approximation of the comparability of terms.

### 1.3. URANIUM RESOURCE CLASSIFICATION SYSTEM

This system, which has been developed by the IAEA and the OECD/NEA for their periodically published uranium database [1.4], combines the degree of confidence in the existence of the resource with the economics of its recovery. These two parts of the classification system are referred to as resource categories and cost categories.

The resource categories broadly separate the resources into those that are known and those that are as yet undiscovered. The known portion is further subdivided into the reasonably assured resources (RAR), which represent the best known parts, and the estimated additional resources category I (EAR-I), while the undiscovered resources include the estimated additional resources category II (EAR-II) and the speculative resources (SR).

The correlation of the above terms with those of other major resource classification systems (Fig. 1.1), which may be better known to the operator, is as follows.

The RAR category represents the highest level of confidence in the estimation. The computed tonnage and grade of the resources are usually judged to be within the limits of  $\pm 20\%$  error. RAR are approximately equivalent to the aggregate of measured resources and the indicated resources as defined by the Canadian Department of Energy, Mines and Resources (EMR) and the US Bureau of Mines (USBM), as well as to the sum of reserves I and II of the French system. The RAR can also be correlated with the categories A1, A2, B and C1 of the former USSR and some other eastern European countries.

The lesser known resource portion category corresponds to the inferred category used by EMR and USBM, to the sum of perspectives I and II of the French terminology and to the C2 category of the USSR. EAR-I proper is not used in the estimation and classification of the US uranium resources, which are instead grouped together under EAR, without separation of the known and undiscovered portions of that resource.

EAR-II, defined as the undiscovered resource spatially located outside the boundaries of RAR and EAR-I, but within well established geological trends of identified uranium mineralization [1.4], is not used by the Australian Bureau of Mineral Resources (BMR). In Canada, Germany and the USBM, EAR-II are equivalent to prognosticated or hypothetical resources, respectively, while in the former USSR, EAR-II corresponded to the P1 category.

The term 'speculative resources' is in use in nearly all the resource classification systems, except in the former USSR, where SR corresponds to the category P2.

The cost categories as defined in the Red Book [1.4] refer to the cost of production, including mining and ore processing, the cost of associated environmental and waste management, as well as the cost related to future exploration and development of unexplored portions of the deposit. Not included are costs that have already been

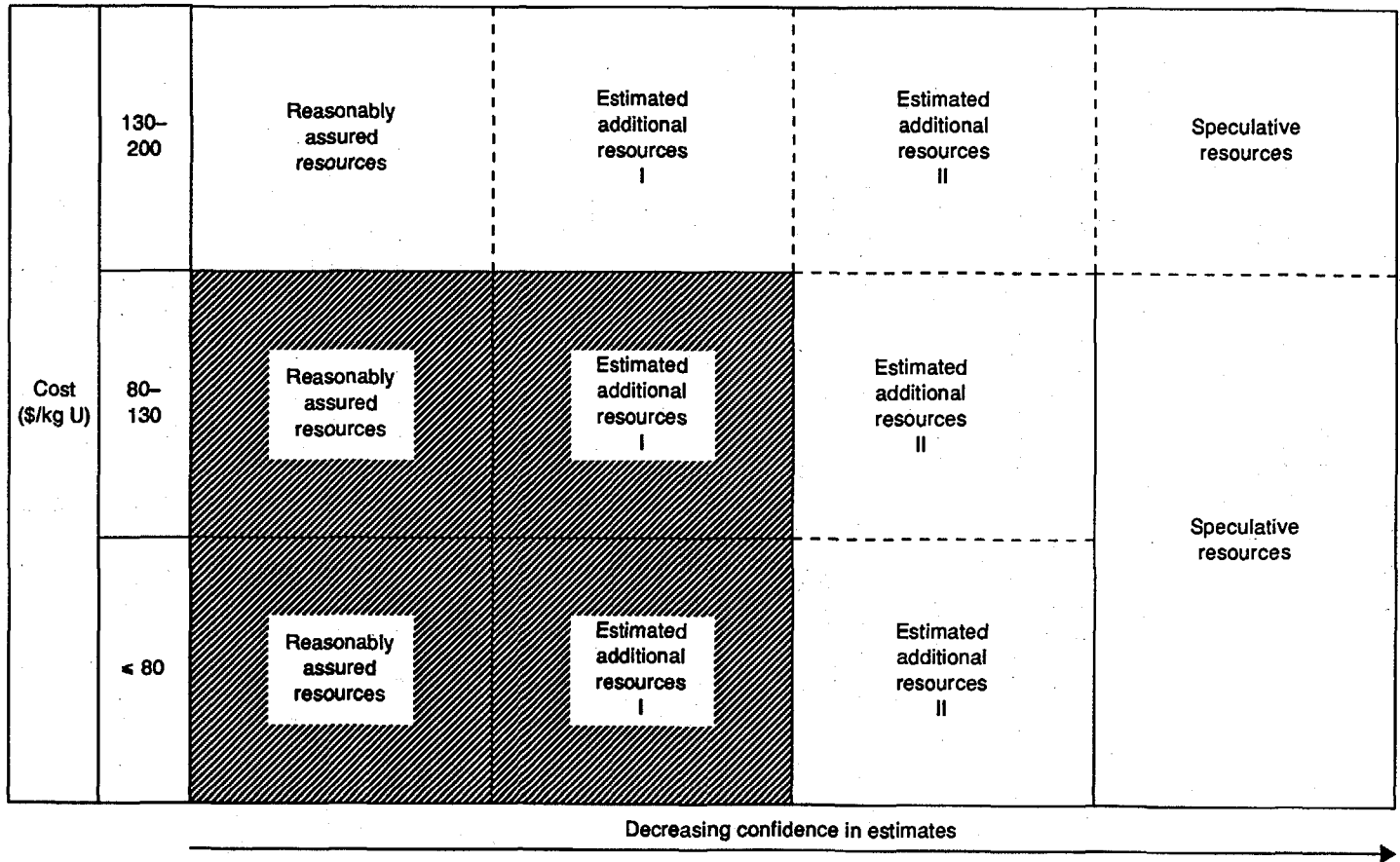

FIG. 1.2. NEA/IAEA classification scheme for uranium resources.





incurred such as the exploration expenditures needed to discover and delineate the deposit that is being mined, and profits.

In the successive Red Books since the mid-1960s, the cost categories were divided into low, higher and highest. The nominal amounts that defined these different levels were modified over the years to reflect the changes in the prevailing economic conditions. At present, the low cost category refers to up to US \$130/kg U, which is subdivided into the range up to US \$80/kg U and the range between US \$80 and \$130/kg U. The higher and highest cost categories refer to those between US \$130 and \$260/kg U, and above US \$260/kg U, respectively.

The combination between the resource categories and the cost categories is shown in Fig. 1.2, where the resource categories according to decreasing confidence in the existence of the resource are shown on the horizontal axis, while the increasing cost categories are arranged along the vertical axis. The shaded area in Fig. 1.2 indicates that, because of the high degree of confidence in their existence combined with low recovery cost, RAR and EAR-I are distinctly important.

#### 1.4. URANIUM RESOURCES IN WOCA

Since the mid-1960s, the IAEA and the NEA have published uranium resource estimates as reported by their respective Member States, in the biannual report 'Uranium Resources, Production and Demand', which became the authoritative source of uranium data [1.4]. As data on uranium resources are considered confidential in certain countries, the available information has been restricted to WOCA.

Despite a cumulative uranium production of over 0.5 Mt U, the WOCA uranium resource base has not changed significantly since 1977. The RAR recoverable at costs of up to US \$80/kg U totalled 1.6 Mt U in 1977 and is now at slightly below 1.5 Mt U (Fig. 1.3). The geographical distribution of these resources, however, has changed, in particular for Australia and the USA. While in 1977 over 31% of the total were located in the USA and 17% in Australia, in 1990 the RAR of these countries were 7 and over 31%, respectively.

The EAR-I category was introduced in 1982 after the EAR were subdivided into the categories I and II. Figure 1.4 shows the development between 1977 and 1990 of EAR and EAR-I recoverable at costs of below US \$80/kg U. In addition, in these cases the stability of the resource estimates is evident. The EAR show only a slight increase between 1977 and 1981, and the EAR-I declined from about 0.85 Mt U in 1983 to 0.75 Mt U in 1990.

Figure 1.5 shows the geographical distribution of the low cost known resources, defined as the aggregate of RAR and EAR-I recoverable at costs of below US \$80/kg U. These resources are of particular interest, as in the producing countries they provide the basis for the present uranium production. For WOCA, these known resources (RAR + EAR-I) amount to over 2.3 Mt U, 78% of which are

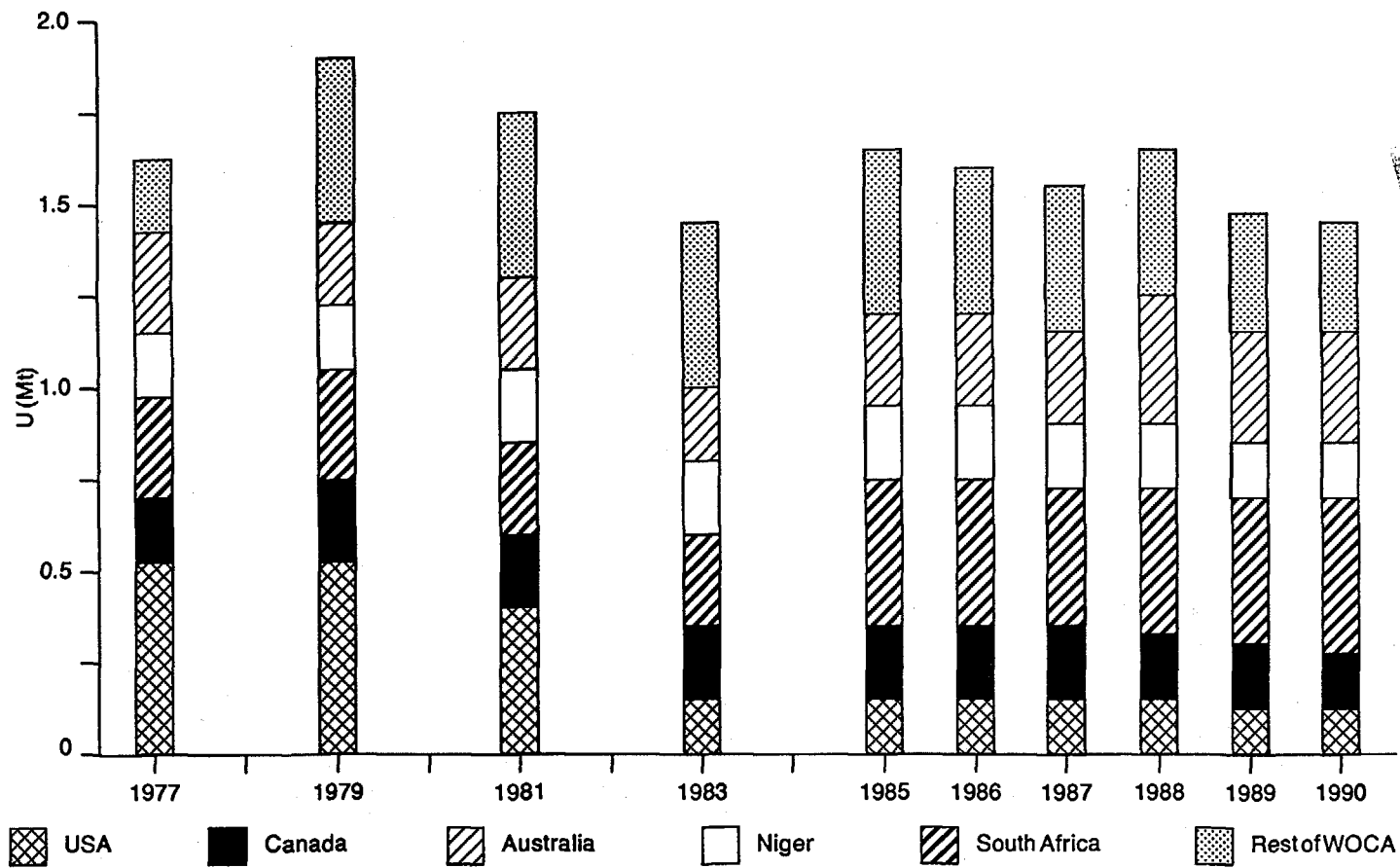

FIG. 1.3. Tonnage of uranium recoverable from RAR at costs of up to US \$80/kg U for the period from 1977 to 1990.

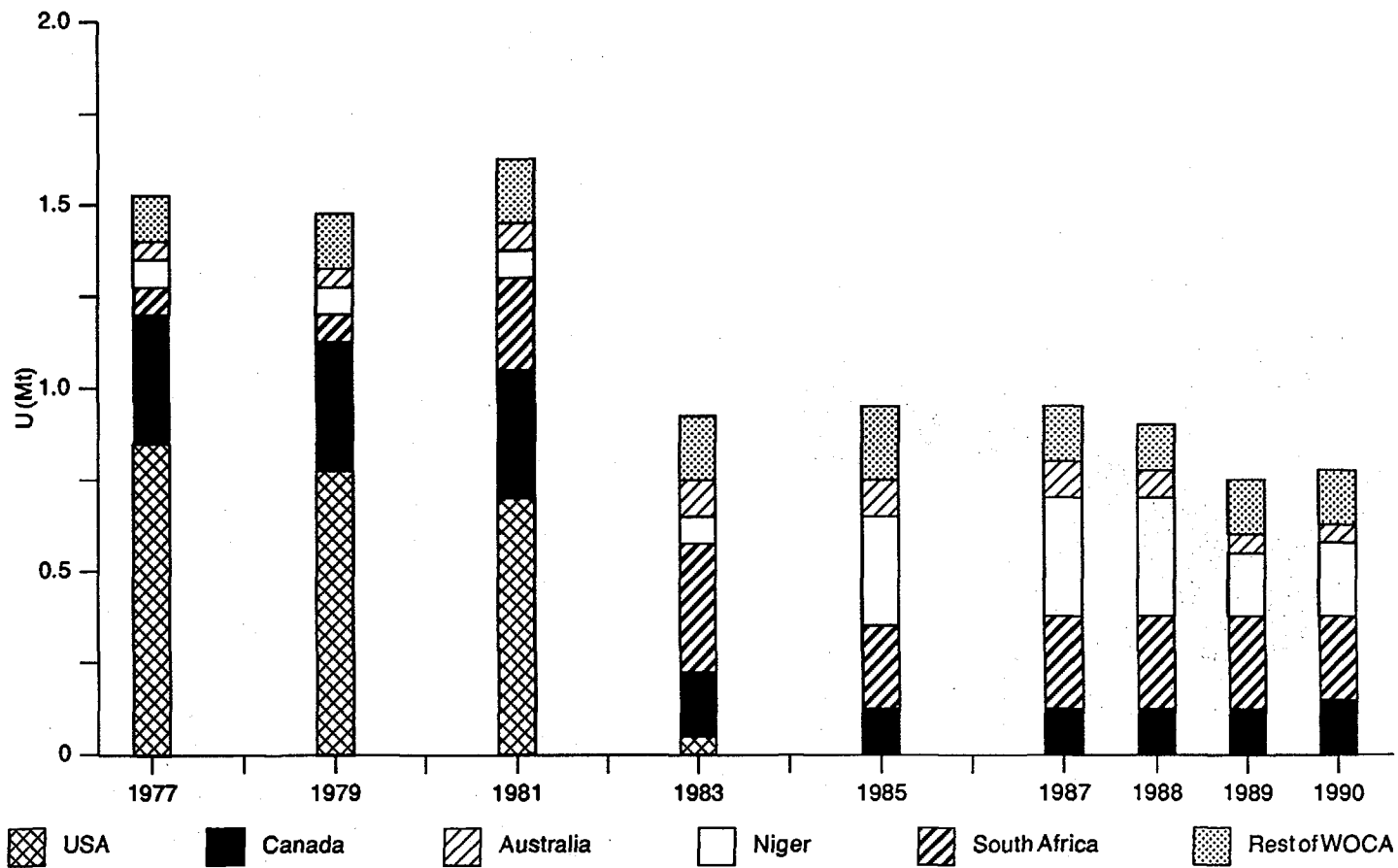

FIG. 1.4. Tonnage of uranium recoverable from EAR-I at costs of up to \$80/kg U for the period from 1977 to 1990.

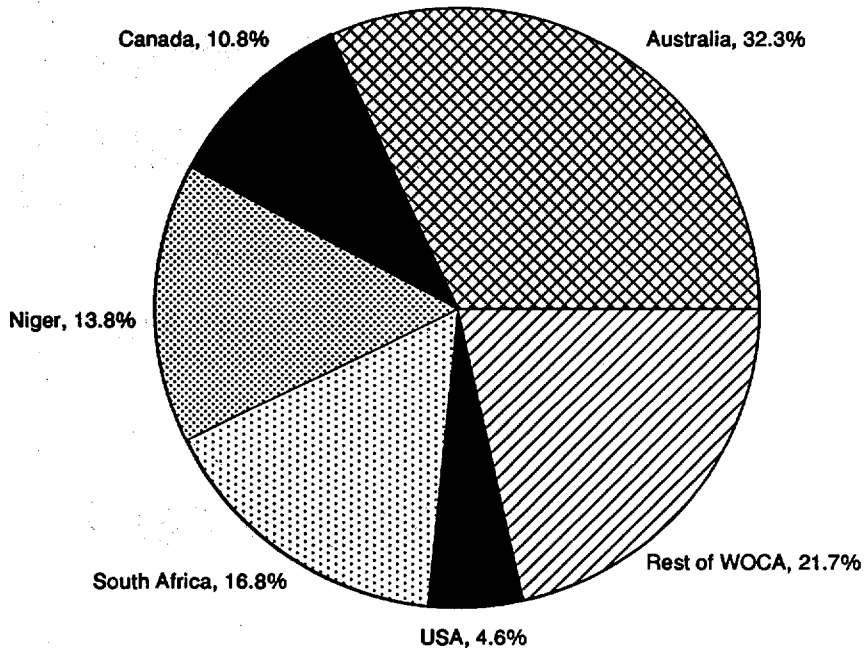

FIG. 1.5. Distribution of WOCA low cost known uranium resources in January 1989. (100% = 2 301 000 t U).

located in five countries: Australia, Canada, Niger, South Africa and the USA. The remainder is in the 'Rest of WOCA', which includes primarily Brazil, France, Gabon and Namibia. As shown, the deposits of low cost known uranium are heavily concentrated in a few countries. The same applies to uranium exploration and production.

#### REFERENCES

- [1.1] INTERNATIONAL ATOMIC ENERGY AGENCY, Methods for the Estimation of Uranium Ore Reserves — An Instruction Manual, Technical Reports Series No. 255, IAEA, Vienna (1985).
- [1.2] INTERNATIONAL ATOMIC ENERGY AGENCY, Methods for the Estimation and Economic Evaluation of Undiscovered Uranium Endowment and Resources: An Instruction Manual, Technical Reports Series No. 344, IAEA, Vienna (1992).
- [1.3] INTERNATIONAL ATOMIC ENERGY AGENCY, Manual on the Projection of Uranium Production Capability, General Guidelines, Technical Reports Series No. 238, IAEA, Vienna (1984).
- [1.4] NUCLEAR ENERGY AGENCY OF THE OECD, INTERNATIONAL ATOMIC ENERGY AGENCY, Uranium Resources, Production and Demand, OECD, Paris (1990).

## Chapter 2

### MINING TECHNOLOGY

#### 2.1. TYPES OF MINING AND MINING PRACTICE

##### 2.1.1. Uranium ore bodies

Very easily solubilized in an oxidizing medium, uranium is an excessively mobile metal that precipitates under reducing conditions.

As seen in Chapter 1, uranium ore bodies are found in many types of environment. From a mining point of view, however, they can be roughly classified into the following two categories:

- (a) Sedimentary ore bodies, present as subhorizontal layers with a thickness varying from several tens of centimetres to several tens of metres,
- (b) 'Vein type' ores, with a variable thickness varying from several tens of centimetres to several tens of metres — often subvertical.

##### 2.1.2. Mining recovery

Mining operations are made easier, compared with those for other mineral ores, through radioactivity measurements. This characteristic makes it possible to locate the mineralization in drill holes easily, to obtain a good selectivity during loading, to sort the ore into different grades, and to determine the size and concentration of a uranium deposit through the instrumentation.

Depending on the ore depth and local environmental conditions, mining recovery can be carried out through either open pit or underground mining.

###### 2.1.2.1. *Open pit mining*

Open pit mining operations, very similar to quarrying works, can be applied to sedimentary and vein type ore bodies.

Rock fragmentation is generally obtained through the use of explosives. Subsequent mining operations produce benches, which are usually five to twenty metres high. In the ore bearing zone the radioactivity in the blast holes is measured and recorded. Uranium can then be located, and a precise zoneography of the uranium concentrations both on the bench surface and within the bench can be established.

The mining machinery is chosen to fit the size of the reserve being exploited. For instance, the complete range of front end loaders or hydraulic shovels can be used for loading. Large exploitations are equipped with electrical shovels having

bucket capacities of up to 25 yd<sup>3</sup> (19 m<sup>3</sup>). The effective capacity of trucks or other haulage vehicles can reach 35 to 170 t.

In the ore bearing zone, for selectivity reasons, the size of the loading equipment is generally small to moderate. Loading is carried out through the use of hydraulic shovels equipped with a backhoe bucket. Mining control is achieved by carefully defining and marking the ore zones. In exceptional cases the truck size can reach 35 to 50 t.

Whenever possible, open pit mining is preferred to underground operations because a higher productivity, better ore recovery, easier dewatering and safer mining conditions can be achieved. However, open pit mining can have a greater environmental impact than underground mining.

Site restoration at the end of a mining operation includes backfilling pits with mine or mill wastes. Many examples of mill tailings deposition in open pits that are mined out can be found throughout the world. Examples include Nabarlek in Australia [2.1], where the ore was completely mined out before milling operations started, Rabbit Lake in Canada [2.2] or Bessines-sur-Gartempe and Lodève in France. Recontouring is frequently carried out to match the surrounding local topography. Revegetation programmes are a current practice. A recent publication presents a comprehensive and detailed review of all aspects of tailings management [2.3].

#### 2.1.2.2. *Underground mining*

The advantages of open pit mining diminish as the ore depth increases and for deposit depths of 50 to 200 m or more it becomes necessary to adopt underground mining.

Somewhat different stoping methods are applied to sedimentary ores and vein type ores.

(a) *Sedimentary ores.* The principal developed ore bodies for this type of deposit are located in the USA and Niger. Equivalent mining techniques have also been applied to the Australian Olympic Dam breccia pipe complex operations started in 1988.

Since these ore bodies are subhorizontal and regular, mining operations can be easily mechanized. Underground deposits are generally exploited by room and pillar methods, with or without abandoned pillars, depending on the grade of ore. When pillars are mined a pneumatic or hydraulic type of backfilling is generally adopted, often with the addition of a low cement content concrete. Fly ash can also be added [2.4].

The percentage of ore that can be mined during the first phase of room and pillar mining depends on the stability of the back, which can if necessary be reinforced with anchor or stabilizer bolts. This percentage is usually around 50%.

Mining machinery must be adapted to the deposit thickness; stopes are generally not less than 2 m high. Drilling jumbos are equipped with one, two or three booms, according to the drift size, which can vary from 7 to 30 m<sup>2</sup>.

The bucket capacity of the loaders used in underground mining can vary from 3.5 to 12 t. The ore is conveyed from the face either directly by belt conveyors or by trucks with effective load capacities of 10 to 30 t.

The scaling and bolting of the roof and ribs can also be mechanized.

(b) *Vein type ores.* Many stoping methods have been developed and tested for uranium mining. The experience acquired has led to methods giving the highest selectivity, in particular the cut and fill method. Whenever the bearing capacity of the ground is good enough, the cut and fill methods are applied, and the vein is cut into horizontal slices, three to four metres thick.

Loading operations, formerly carried out by slushing, are currently being performed by trackless equipment. These machines are well suited for irregular mineralizations. With thick veins, the mining of a slice can be carried out in two or three passes.

The broken ore is removed through chutes that are installed as the stoping proceeds. It is then loaded through a bottom gate, either via hoppers or front end loaders, into trucks or mine cars.

Access to a stope can be gained from a timbered raise equipped with floors and ladders for miners. It can also be gained from an incline that follows the vein and has cross-cuts giving access to each slice.

After the bottom slice has been mined out it is backfilled before work proceeds to the upper slice. This can be filled with sand from the mill. In cut and fill methods, hydraulic filling is generally used.

When the strength of the ore is not adequate for safe working, top slicing methods are used. An artificial roof can be made by backfilling with a low cement content concrete or by forming a concrete slab. The thickness of the slab depends on the width of the slice, and the slab can be reinforced. Filling materials can also be added.

Ore haulage (hoisting) to the surface in both sedimentary and in vein type mines is carried out by hoisting through a shaft equipped with a skip or on a decline equipped with a belt conveyor. In both cases the ore is generally broken to minus 200–300 mm before haulage to the surface. In small mines, ore is hauled to the surface in 20 to 30 t capacity trucks that use the same decline as the mining personnel.

The choice between a shaft or a decline is dictated by the local topography, the mine size, etc. When the mine is deeper than 400–800 m, shaft hoisting is generally selected.

Vertical holes are drilled with a raise boring machine to provide mine ventilation.



## 2.2. RADIOLOGICAL AND ENVIRONMENTAL ASPECTS

Safety considerations in a uranium mine, relate to:

- (a) The usual risks in every modern metal mining operation: noise, vibration, physical and chemical respiratory hazards, rock falls, etc.
- (b) Direct exposure to radiation and radon inhalation.

Uranium mining and ore treatment operations create a radiation exposure that must be monitored and controlled to levels consistent with national rules and international recommendations [2.5].

### 2.2.1. Identification of radiological risks

#### 2.2.1.1. Direct radiation

The radionuclides present in the ore are primarily  $\gamma$  ray emitters; 83% of the energy comes from  $^{214}\text{Bi}$  and 12% from  $^{214}\text{Pb}$ . Both of these are short lived descendants of  $^{222}\text{Rn}$ . Typically, at the middle of a drift in a 0.1% uranium ore body, the dose ratio is about  $5 \mu\text{Gy/h}$ . A risk of exceeding the annual limit of 50 mSv exists when the ore grade exceeds 0.5%.

#### 2.2.1.2. Dust

A second radiological risk comes from the inhalation of ore dust, which then accumulates in the lungs. These dust particles contain long life  $\alpha$  emitters:  $^{238}\text{U}$ ,  $^{234}\text{U}$ ,  $^{230}\text{Th}$ ,  $^{226}\text{Ra}$  and  $^{210}\text{Po}$ .

Most of the radioactive atoms contained in the inhaled radioactive dust are eliminated biologically before they are able to disintegrate and release their energy. Nevertheless, the annual degree of contamination may become critical when the stopes are extremely dusty, and when the ore grade exceeds 0.5% U. In this case this risk becomes comparable with the others.

The risk from dust may become the principal hazard in open pits especially in dry climates or in ore treatment mills, in particular in the crushing and grinding sections. The operators must be equipped with dust masks or some other form of protection for some types of work so as to minimize dust inhalation.

#### 2.2.1.3. Radon

A third radiological risk comes from the inhalation of radon and its daughter products. Radon, a short lived  $\alpha$  particle emitter, is a noble gas capable of migrating in rocks. The inhalation of radon is not a risk in itself because it does not remain in the lungs. It is either exhaled or it is distributed throughout the body via the circu-

lation of blood, if it has entered the pulmonary tissues. However, when  $^{222}\text{Rn}$  disintegrates, it generates short lived solid daughter products ( $^{218}\text{P}$ ,  $^{214}\text{Pb}$ ,  $^{214}\text{Bi}$ ). These isotopes, once fixed on mining aerosols, may settle in the lungs and emit their disintegration energy.

#### 2.2.1.4. Relative importance of the three types of risks

Of the three risk factors contributing to the annual average dose (as a sum of these three risks), the risk from radon is preponderant. It represents 50 to 75% of the total risk for the underground mining of vein type ores. For the highly mechanized underground mining of sedimentary type ores, the risk from dust is preponderant (50%), the risk from the other two factors being about 25% each. The same distribution of risk factors is experienced in open pit mining and ore treatment mills.

#### 2.2.2. Regulatory aspects

In any examination of the exposure risks due to ionizing radiations, it is necessary to refer to the recommendations of the International Committee for Radiological Protection and to its basic principles on individual dose limit measurements and protection optimization [2.6].

The cumulative formula for the three risk factors is given by the following equation, where the total must be less than one,

$$\frac{H_p}{0.05 \text{ Sv}} + \frac{IP \cdot M(U)}{1.7 \cdot 10^3 \text{ Bq}} + \frac{JR(^{222}\text{Rn})}{0.02 \text{ J}} < 1$$

in which:

- $H_p$  is the maximum annual dose equivalent due to external irradiation (in sieverts),
- $IP \cdot M(U)$  is the  $\alpha$  particle activity of uranium ore dust inhaled during one year (in becquerels) and
- $JR(^{222}\text{Rn})$  is the  $\alpha$  particle potential energy of the  $^{222}\text{Rn}$  descendants inhaled during one year (in joules).

When the risk from  $^{220}\text{Rn}$  is significant, or when thorium ore is exploited, it is necessary to take into consideration these two radionuclides and add the following terms to the formula:

$$\frac{IP \cdot M(\text{Th})}{300 \text{ Bq}} + \frac{JR(^{220}\text{Rn})}{0.060 \text{ J}}$$

### 2.2.3. Dosimetric survey of workers

Three types of dosimetry measurements may be considered:

- (a) An individual dosimetry based on the results of the recorders worn by individual workers during their work. These recorders accumulate the internal and external irradiations received during a month.
- (b) A function dosimetry based on the results from recorders worn by a sample of workers that is representative of the various functions and conditions that are encountered in the mine. These recorders allow for the determination of the average levels of internal and external irradiation for each type of work function. From the time each worker spends on each function, it is then possible to calculate the individual exposure.
- (c) An ambient dosimetry to monitor the control of the atmosphere in work places during different working phases. From these measurements the average concentrations of radionuclides may be calculated at each work place.

The European Community Council suggests the use of:

- (1) An individual dosimetry for those workers liable to receive an annual dose of higher than 0.7 of the regulated limit (category A workers: those in underground mines).
- (2) A function dosimetry for those workers liable to receive an annual dose of between 0.1 and 0.7 of the regulated limit (category B workers: those in open pits and ore treatment mills). Ambient dosimetry may also be used for this second category of workers, if accurate records can be maintained.
- (3) An ambient control for workers who may receive less than 0.1 of the annual limit. These workers are considered as not being exposed to ionizing radiations. Only an ambient control must be made to verify that the 0.1 limit is not exceeded.

### 2.2.4. Radiological impact of ore mining and ore treatment on the environment

The main irradiation sources are given in the next seven subsections, in decreasing degree of radioactivity.

#### 2.2.4.1. *Tailings from uranium ore treatment mills*

This source may give the highest possible number of release pathways: external irradiation by direct exposure,  $^{222}\text{Rn}$  emission, possible dust dispersion by the wind, soluble radionuclides leached by the rainwater and pollution due to a dam failure.

#### 2.2.4.2. *Gaseous and liquid effluents from underground mining*

Gaseous effluents from mine exhaust fans may be the origin of local sources of  $^{222}\text{Rn}$  (radioactive dust emission is generally negligible owing to precautions already taken in the mine). Liquid effluents, sources of  $^{226}\text{Ra}$  and  $^{238}\text{U}$ , can be adequately treated and monitored [2.7].

#### 2.2.4.3. *Effluents from open pits*

Open pits are major emitters of gaseous effluents and radioactive dusts. These are not easily monitored and are of variable intensity owing to varying atmospheric conditions and to varying mining techniques. Liquid effluents, as in underground mines, can be treated and monitored.

#### 2.2.4.4. *Ore stockpiles*

Release pathways the same as those for tailings are possible, but with less intensity: the physical and chemical characteristics are less favourable for these transfers.

#### 2.2.4.5. *Static leaching heaps*

The activity in leaching heaps is lower than that in ore stockpiles, and it can be considered that gaseous effluents and dust emission are negligible. For liquid effluents the risk is again negligible because the heaps are constructed on impervious membranes.

#### 2.2.4.6. *Airborne and liquid mill effluents*

Airborne sources are mainly radioactive dusts, such as ore dusts at the beginning of the ore treatment cycle, and uranate dusts at the end of the cycle. The major part of these dusts are removed by industrial gas cleaners. Liquid effluents can be easily treated and monitored.

#### 2.2.4.7. *Mining wastes*

The tonnage of mining waste produced from underground mines is low but may be important for open pits. A large part of the open pit wastes can be recovered for backfilling, for landscape modelling and for road construction on the mining site. However, since these mining wastes always contain traces of radioactive elements they should not be made available to the public.

Quantifying the radiological consequences of mining and milling operations for the environment and the local population is complex. This subject is discussed further in Chapter 10.

### 2.3. GRADE CONTROL

From geological exploration to ore stockpiling at the mill it is of paramount importance to have comprehensive information about the uranium concentrations of the various mine products. Compared with other mineral ores, developing this information is made easier through the use of radiometric measurements, which can give accurate and reliable results.

#### 2.3.1. General theory

Gamma radioactivity, measured by scintillometers or classical Geiger counters, is proportional to the quantity of the radioelement 'seen' by the crystal or the counting tube. This activity comes mainly from  $^{214}\text{Bi}$ , which produces 83% of the emission, and  $^{214}\text{Pb}$ , which produces 12% of the emission.

Generally,  $^{226}\text{Ra}$  or 'equivalent radium' (eRa) is reported instead of  $^{214}\text{Bi}$ . This implies that  $^{226}\text{Ra}$  and  $^{214}\text{Bi}$  should be at an equilibrium stage, i.e. there is no radon leakage. It is then possible to write

$$R = kt'd \quad (2.1)$$

where  $R$  is the radioactivity,  $t'$  the eRa grade and  $d$  the dry density. The factor  $k$  depends on the units used for  $t'$  and eRa. The dry density,  $d$ , can also be related to the 'in situ' density  $d'$ , which is a wet density that varies with the ore porosity,  $p$ , expressed as a percentage:

$$d = d'(1 - p) \quad (2.2)$$

The eRa grade,  $t'$ , and the uranium grade,  $t$ , are linked by the following equation:

$$t = t' \frac{U}{\text{eRa}} \quad (2.3)$$

where  $U/\text{eRa}$  is the equilibrium ratio between uranium and its Ra decay products.

From (2.1), (2.2) and (2.3) it is then possible to write the following equation:

$$t = \frac{1}{k} R \frac{U}{eRa} \frac{1}{d'(1-p)}$$

where  $U$ ,  $eRa$  and  $R$  are derived from measurements of radioactivity. Details of the methods used for these measurements and the units are presented in Ref. [2.8].

Therefore, it appears that for a fixed value of radioactivity  $R$ , which is the physical parameter being measured, the uranium grade increases with an increase of the equilibrium ratio  $U/eRa$ . (For example, that which occurs from the leakage of radon gas in newly crushed ore or in high porosity materials such as 'episyenitic' mineralized facies of the Limousin Province in France.)

The correlation between the radioactivity and the uranium grade can be established for each type of ore through adequate sampling, thus permitting a representative value of the uranium grade for each value of the measured radioactivity. Such measurements and correlations avoid the potential for error when there are variations in equilibrium ratio, or when there are changes in the uranium bearing host rock.

### 2.3.2. Grade control during exploration

#### 2.3.2.1. *Surface prospecting*

Together with the geological mapping, uranium prospecting on the surface is conducted with conventional Geiger counters or scintillometers. These well known portable items of equipment are very sensitive, and the measurements can be used to make isocontour maps of the ground radioactivity and locate anomalies and occurrences [2.9].

#### 2.3.2.2. *Subsurface exploration*

Selected anomalous zones are explored by drilling. The use of percussion drilling rather than core drilling provides important savings in exploration expenditures. In some cases, however, core drilling may be more reliable.

After each drill hole is completed a calibrated gamma ray probe is introduced to generate a radiometric log. This log can be translated into 'radiometric grade'. Geostatistical methods are used to estimate the tonnages of ore and the average grade of a deposit that has been delineated by systematic grid drilling.

Use of these methods provides a first global estimation of the grade of the ore body. This type of global evaluation can then be iterated to improve the geological model by integrating the mining constraints. The amount of recoverable uranium can

finally be determined as a function of cut-off grade, stope thickness, block size selection, etc. This information is used to develop an optimum mining plan [2.10].

### 2.3.3. Grade control during mining

Grade control is an ongoing task during mining exploitation. Measurements and evaluations are made:

- (a) *Before blasting:* To guide the mining teams by giving them the mineralized volume according to cut-off grade and local stope constraints. This grade control is based on radioactivity measured either by a counter on the wall face or by a gamma ray probe in blast holes.
- (b) *After blasting:* To sort ore and waste mixed during blasting so as to avoid milling material that would be too expensive to process. During mucking it is possible to segregate the different types and grades of ores and waste with a good selectivity.

Haulage vehicles pass under a radiometric bridge to identify more carefully and separate out the various ore stockpiles. These radiometric bridges can also provide an initial estimate of the potential production from each section, stope or bench.

### 2.3.4. Grade control during ore haulage delivery to the mill

Various grades of ore can be stockpiled at the pit head in heaps or in bins if the ore is hoisted in skips. The average quality ore is then transported to the mill in trucks, which generally have an effective load of 25–30 t. To estimate the ore tonnage and ore grade accurately and to distribute the ore into various stockpiles, the following measurements are made:

- (a) The wet weight is determined by a weigh bridge — the dry weight is then calculated from the moisture content.
- (b) The radioactivity is determined by a radiometric bridge — the measurement is then converted into ore grade through the use of a straight line correlation factor.

Through these measurements at the delivery point it is possible to:

- (1) Account for the production by the mine or stope. The values obtained can give an estimate for the control of the ore dilution and for the anticipated uranium grade versus the obtained grade.
- (2) Manage ore stockpiles into various grades to avoid major fluctuations and help the mill to meet its production programmes.

## 2.4. CO-ORDINATION WITH MILL

In a certain sense, the ore stockpile at the front of the mill can be considered as a boundary where the work of the geologists and miners ends and that of the metallurgists begins.

Such a stockpile is necessary to provide a uniform ore feed in quantity and quality and to help the mill to meet its production requirements. This stockpile often consists of several heaps on an impervious surface equipped with some device for rainwater recovery. When particular constraints arise, generally connected with environmental reasons (high grade ores, heavy rain, strong wind or very cold climate), the ore stockpiles can be roofed over or the ore may be stockpiled in bins.

In order to assure a continuous supply of ore for the mill, a stockpile corresponding to at least one to two months of ore feed is frequently maintained. Ore is transferred to the bin at the mill feed, either by a front end loader or by a reclaim tunnel feeding a belt conveyor.

The various categories of ore are stockpiled separately. In the simplest case, where, for instance, the mill is fed by a single sedimentary mine with a homogeneous ore, the ore is classified into various grades: rich, average and poor. Occasionally, another category can be established for heap or vat leaching operations.

In more complex cases, the same mine may produce different categories of ore or a regional type mill may receive ores from several mines. A classification by ore types may then be superimposed on the classification by ore grade.

In some cases, where an ore is very different from the others, a high clay content ore for instance, a separate physical preparation line (e.g. grinding, beneficiation) may be erected to treat this particular ore.

TABLE 2.1. ORE CLASSIFICATION SYSTEM USED AT THE COGEMA MILL AT BESSINES-SUR-GARTEMPE IN FRANCE

Acid consumption	High acid consuming matrix (acid consumption growing quickly with acid input)	Low acid consuming matrix (acid consumption growing slowly with acid input)
Sulphuric acidity		
Low free sulphuric acidity necessary at the end of the leach	1	2
High free sulphuric acidity necessary at the end of the leach	3	4



The mill can be fed with a blend of different ores or the mill can treat various ores separately. For instance, at the Compagnie générale des matières nucléaires mill at Bessines-sur-Gartempe the ore is classified into the four types shown in Table 2.1.

Before this classification system was established, the ore feed was made from a blend of these four types. After the system was placed in operation, the treatment of these four categories separately produced a significant acid saving of around 15–20 kg/t of ore.

#### 2.4.1. Metallurgical balance

Uranium mills are usually equipped with both a precise weighing unit to measure the amount of ore fed to the mill and a system for collecting a representative sample of the ore feed. Sampling of the ground raw ore pulp is used in some mills. Even though the procedures for collecting this type of sample are significantly less complex than those for the dry ore, good representative samples are obtained. The mining and metallurgical control team use the following feed samples for purposes of comparison:

- (a) The uranium grades from the mill feed samples and the measurements obtained by the radiometric measurements;
- (b) The weight from the mill weighing unit and that from the weigh bridge.

The control team can then re-evaluate and make corrections for the uranium production from the mine and for the uranium contained in the stockpiles. It is of paramount importance in a mining–milling operation to have frequent meetings between miners, geologists and metallurgists to co-ordinate and optimize the overall operation.

### REFERENCES

- [2.1] LUCAS G.C., NELSON I.F., WALKER P.J., "Mining and ore processing at Queensland Mines Ltd NABARLEK uranium processing plant", The Australian Institute of Mining and Metallurgy Conference (Proc. Conf. Darwin, 1984), Presses Universitaires de France, Paris (1984).
- [2.2] PHILLIPS, R.L.J., Rabbit Lake Project Environmental Impact, Canadian Inst. of Mining and Metallurgy Bulletin, Montreal (1989).
- [2.3] RITCEY G.M., Tailings Management, Problems and Solutions in the Mining Industry, Elsevier, Amsterdam (1989) 970.
- [2.4] CREW, R.J., Mining and Metallurgical Practices at Olympic Dam, South Australia, Bergbau (1989).
- [2.5] INTERNATIONAL ATOMIC ENERGY AGENCY, Radiation Monitoring in the Mining and Milling of Radioactive Ores, Safety Series No. 95, IAEA, Vienna (1989).

- [2.6] INTERNATIONAL ATOMIC ENERGY AGENCY, Application of the Dose Limitation System to the Mining and Milling of Radioactive Ores, Safety Series No. 82, IAEA, Vienna (1987).
- [2.7] INTERNATIONAL ATOMIC ENERGY AGENCY, The Application of the Principles for Limiting Releases of Radioactive Effluents in the Case of the Mining and Milling of Radioactive Ores, Safety Series No. 90, IAEA, Vienna (1989).
- [2.8] COMMISSARIAT A L'ENERGIE ATOMIQUE, CETAMA, Analytical Methods, Presses Universitaires de France, Paris (1964) (in French).
- [2.9] INTERNATIONAL ATOMIC ENERGY AGENCY, Construction and Use of Calibration Facilities for Radiometric Field Equipment, Technical Reports Series No. 309, IAEA, Vienna (1989).
- [2.10] INTERNATIONAL ATOMIC ENERGY AGENCY, Methods for the Estimation of Uranium Ore Reserves: An Instruction Manual, Technical Reports Series No. 255, IAEA, Vienna (1985).



**Part II**

**PROCESSING TECHNOLOGY**



## Chapter 3

### PROCESSING CONCEPTS

In the treatment of any ore or concentrate there will be several options available from which to select the process best suited to that particular feed material. Uranium extraction follows this general pattern. Basically, the usual type of unit operations will be used and the real difference will be in the implementation of these unit processes. A schematic diagram of the typical extraction process flow sheets is given in Fig. 3.1. Variations due to the feed, the dissolution process used, and the type and grade of product desired will dictate the choice. The choice will be further influenced by the increasing demand for minimal environmental impact from uranium processing.

In the overall process that is shown the ore is crushed and ground to the size required to provide maximum liberation of the uranium in the subsequent leaching stage. Although not shown in the diagram, it may be necessary to roast the ground ore if appreciable organic carbon is present, as this could cause problems in the purification circuit. Depending upon the hardness of the ore, the grinding will be in semiautogenous or autogenous mills.

Leaching has generally been carried out by using a sulphuric acid leach together with an appropriate available oxidant to convert the  $U^{4+}$  to  $U^{6+}$  to make the uranium soluble. Thus, in atmospheric leaching, the choice of oxidants has included sodium chlorate, manganese dioxide, air, oxygen and Caro's acid ( $H_2SO_5$ ) [3.1]. Pressure leaching has utilized air or oxygen, and heap and in situ acid leaching have been assisted by the use of the bacteria, *Thiobacillus ferrooxidans*, to convert the  $Fe^{2+}$  to  $Fe^{3+}$ , which then provides the oxidizing medium for solubilizing the uranium. In certain ores where there is a high acid consumption due to the mineralogy of the gangue material the leaching has been carried out in a medium consisting of a mixture of sodium carbonate and sodium bicarbonate. In addition, although not a process that has been used commercially, a roast in a chlorine atmosphere is an alternative to solubilizing the uranium as a chloride, together with the soluble radionuclides [3.2-3.6].

Solid-liquid separation is the most expensive of the milling unit operations, both in capital and in operating costs [3.7]. Therefore, there has been considerable attention paid to reducing those costs by the development of more effective flocculants, and high capacity thickeners and belt filters. These replace the drum filters, leaf filters, pressure filters and regular thickener designs previously used.

Solution purification is normally attained by using either ion exchange or solvent extraction, or by a combination of the two processes [3.8]. In the latter case, the uranium is eluted from the resin and the eluate then further processed, and purified, by solvent extraction. This combined process is generally referred to as the

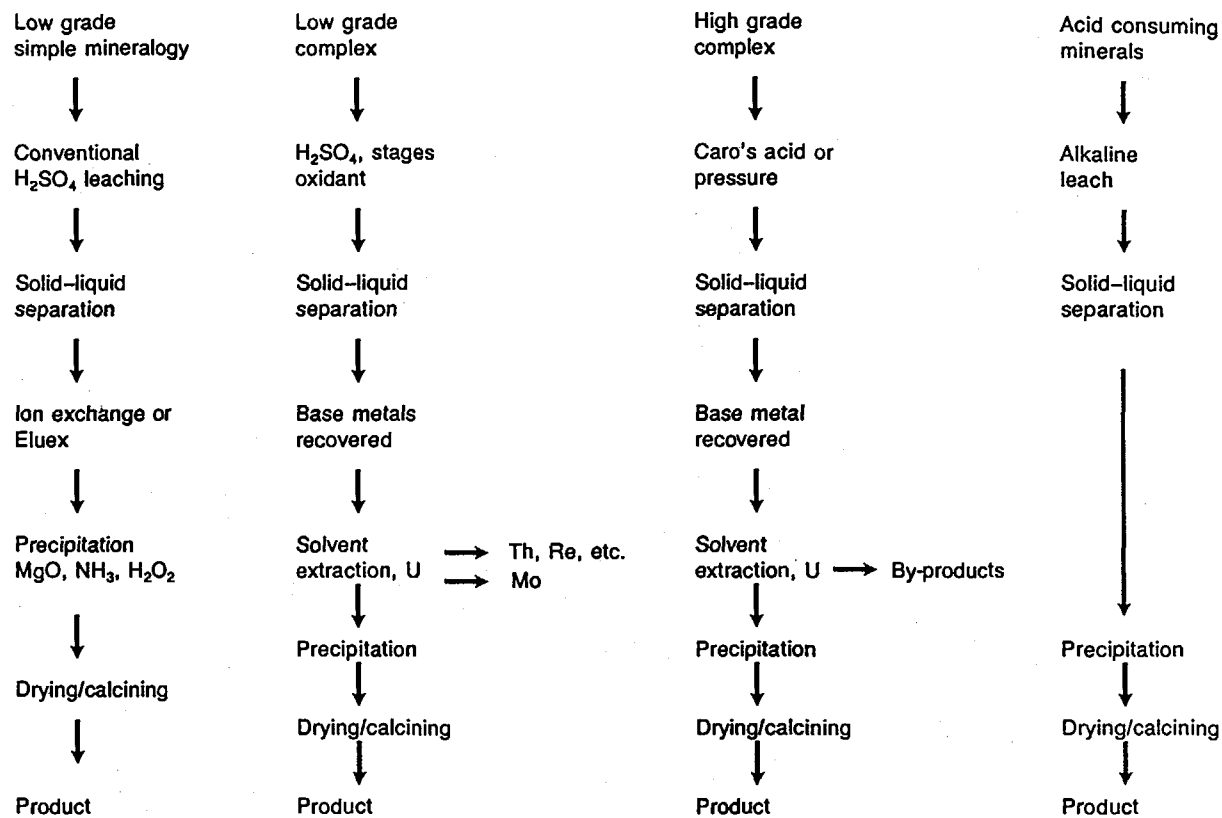

FIG. 3.1. Process options for treating various types of ores.

Eluex process. There has not been much change from the strong base resins for ion exchange, although there continue to be developments in improved resins for resin-in-pulp applications. Continuous ion exchange has further reduced the processing costs. The tertiary amines continue to be the preferred extractant in solvent extraction. Mixer settlers have been improved in order to increase throughput and also to decrease the formation of stable emulsion. In addition, other contactors such as the sieve-plate pulse columns have started to become more popular. Solvent-in-pulp technology [3.9] is only now becoming accepted as a possible improvement in the process to further reduce the costs.

Although not shown in Fig. 3.1, there is now more interest in 'added value', so that, where possible, by-products are being generally considered for recovery.

The final product is usually produced by precipitation, using magnesia, ammonia or hydrogen peroxide (after pH adjustment) [3.10]. Calcining of the precipitate completes the process.

The tailings impoundment receives a variety of effluents from the total operation, and efforts are directed towards dewatering, water recycling to the mill, and eventual covering and reclamation of the area.

As noted earlier in this section, there are a number of possible variations in the treatment of the uranium ore, but the greatest influence arises from the mineralogy of both the uranium minerals as well as the gangue minerals in the feed material. The mineralogy is also extremely important as applied to the design and management of the tailings impoundment system [3.11].

The following sections give details of the many important aspects of the various unit operations involved in the extraction process for treating uranium ores.

## REFERENCES

- [3.1] HAQUE, K.E., RITCEY, G.M., Comparative efficiency of selected oxidants in the acid leaching of uranium ores, CIM Bull. (May 1982) 127.
- [3.2] HAQUE, K.E., RITCEY, G.M., LUCAS, B.H., Hydrochloric acid leaching of an Elliot Lake uranium ore, CIM Bull. (July 1980).
- [3.3] CAMPBELL, M.C., RITCEY, G.M., "Application of chloride metallurgy to base metal sulphide and uranium ores at CANMET", Extraction Metallurgy (Proc. Int. Conf. Montreal, 1981), Institute of Mining and Metallurgy, Montreal, Quebec (1981) 76-90.
- [3.4] CAMPBELL, M.C., RITCEY, G.M., "Chloride metallurgy for uranium recovery: Concept and costs", Ore Processing/Tailings Conditioning (Proc. NEA Workshop Fort Collins, 1982), Colorado State University, Fort Collins, CO (1982).
- [3.5] RITCEY, G.M., HAQUE, K.E., LUCAS, B.H., SKEAFF, J.M., Uranium Ore Processing, US Patent 4,374,096, US Govt Printing Office, Washington DC (1983).
- [3.6] DEMOPOULOUS, G.P., RITCEY, G.M., Pressure Leaching of Uranium Ores in a Chloride Medium, Canadian Patent 1247372, Canadian Patent Office, Montreal, Quebec (1988).



- [3.7] GOW, W.A., RITCEY, G.M., The treatment of Canadian uranium ores: A review, CIM Bull. (Dec. 1969) 1330-1339.
- [3.8] RITCEY, G.M., ASHBROOK, A.W., Solvent Extraction: Principles and Applications to Process Metallurgy, Vols 1 and 2, Elsevier, Amsterdam and New York (1982).
- [3.9] RITCEY, G.M., LUCAS, B.H., SLATER, M., "A comparison of the processing and economics of uranium recovery from leach slurries by continuous ion exchange or solvent extraction", Hydrometallurgy (Proc. Int. Symp. Chicago, 1973), American Institute of Mining, Metallurgical and Petroleum Engineers, New York (1973).
- [3.10] HOPKINS, J.S., GOLDING, J.A., RITCEY, G.M., The critical factors influencing uranium precipitation by hydrogen peroxide: The use of experimental design techniques, J. Hydrometall. 17 (1986).
- [3.11] RITCEY, G.M., Tailings Management — Problems and Solutions in the Mining Industry, Elsevier, Amsterdam and New York (1989) 970 pp.

## Chapter 4

### ORE PREPARATION

#### 4.1. INTRODUCTION

Conventional uranium ore milling begins with comminution of the ore to prepare it for processing. In most mills the ore preparation step involves crushing and grinding operations to produce a sized ore suitable for acid or alkaline leaching. The feed preparation requirements are nearly always specific to the site. Whereas the early mills used relatively standard crushing and grinding circuits, nearly all of the recently constructed operations have installed semiautogenous grinding systems.

Over the years there has been considerable interest in preleach beneficiation, but relatively few applications have been possible. The potential economic advantages when treating low grade resources are particularly significant. Where applicable, radiometric sorting has effectively separated barren gangue material.

Roasting operations have been used principally for the treatment of carnotite ores containing appreciable vanadium concentrations.

#### 4.2. CRUSHING AND GRINDING

##### 4.2.1. Introduction

Because the uranium minerals in most deposits are finely disseminated and intimately associated with the gangue, they must initially be 'unlocked' or liberated before separation or leaching can take place. The primary objective of crushing and grinding in the vast majority of uranium milling operations is to produce the degree of liberation required for effective leaching. With a few notable exceptions, physical beneficiation has not been applied for concentrating uranium. These exceptions include Radium Hill in Australia [4.1], together with the Palabora [4.2] and Ergo [4.3] operations in South Africa. The beneficiation process significantly improved the economic performance in these operations. In most uranium operations, however, beneficiation has not been mandatory for achieving economic viability.

A secondary objective of the crushing and grinding operations is to produce a material that can be slurried and pumped through the processing circuits. The degree of grinding required to achieve these objectives for different ores may vary considerably. For example, sandstone ores normally require only that the sand grains be broken apart and the surfaces scrubbed sufficiently to provide the leaching agents with access to the uranium minerals. It is rarely necessary to fracture the grains of

a sandstone ore because the uranium occurs primarily in the cementing material between the grains. Other ores, in particular those containing refractory minerals, may require breakage of the grains.

Depending upon the type and mineralogy of the ore being processed, the required grind may vary from 5 to 0.074 mm (3 to 200 mesh). The degree of grinding required for each ore source must be carefully evaluated, but some general trends are discernable. For example, agitation acid leach operations on most sandstone ores require grinds in the  $-0.6$  mm ( $-28$  mesh) to  $-0.4$  mm ( $-35$  mesh) range, while that for limestone ores treated by alkaline leaching has normally been  $-0.2$  mm ( $-65$  mesh). The grinding requirements for conglomerate ores are usually finer and vary more. A grind of 50% passing 0.074 mm (200 mesh) is not uncommon, and for some ores much finer grinding may be desirable. A few ores, such as those produced from the intrusive Rossing type of deposit, leach at much coarser sizes (95%,  $-1.7$  mm).

#### 4.2.2. Comminution theory

Comminution theory concerns the relationship between energy input and the product particle size produced from a given size of feed material. A number of theories have been proposed, none of which have proven generally applicable.

The principal difficulty relates to the fact that most of the energy input to a crushing or grinding unit is absorbed by the machine itself. Only a small portion of the energy input is available for size reduction. For example, in a ball mill, less than 1% of the total energy input is used for particle breakage [4.4]. The bulk of the energy input transforms into heat.

Another problem is that all of the theories assume that the material being crushed or ground is brittle. When a material is plastic, however, energy will be consumed when it changes shape. Forming this new shape uses up energy without creating a significant new surface.

The oldest theory is that of von Rittinger, which dates from 1867 [4.5]. This theory states that the energy consumed is proportional to the area of new surface produced.

The second theory was proposed by Kick in 1885 [4.6]. In this theory the work required is proportional to the reduction in volume of the particles concerned.

In 1952 Bond proposed a third theory of comminution [4.7]. This theory is based on the premise that the work input is proportional to the new crack tip length produced during particle breakage, which is equal to the work represented by the product minus that by the feed. For particles with similar shapes, the surface area of a unit volume of a material is inversely proportional to the diameter. The crack length of a unit volume is considered to be proportional to one side of that area and, therefore, inversely proportional to the square root of the diameter.

Researchers have attempted to show that the relationships of von Rittinger, Kick and Bond are interpretations of a single general correlation. In 1975 Hukki [4.8] suggested that the relationship between energy and particle size is a composite of the three laws. The probability for breakage during comminution is high for large particles and diminishes rapidly as the particle size is reduced. Hukki showed that Kick's law covers the crushing range above about 1 cm in diameter with reasonable accuracy. For conventional rod and ball mill grinding, Bond's theory applies reasonably well. Rittenger's law pertains fairly well in the fine grinding range of 10–1000  $\mu\text{m}$ .

### 4.2.3. Grindability

Grindability indices refer to the ease with which materials can be crushed or ground; they are based on data from grindability tests. The Bond work index is probably the most widely used grindability parameter [4.9]. If the breakage characteristics of a material remain constant over all size ranges, then the calculated work index will remain constant since it expresses the resistance of the material to comminution. For the most naturally occurring raw materials, however, the breakage characteristics vary with particle size. For example, when a material breaks easily at the grain boundaries but the individual grains are tough, grindability varies with the fineness of the grind. Consequently, work indexes are determined for the specific grind size desired. The Bond grindability index is based on performance in a carefully defined piece of equipment according to a strict procedure. Bond has devised several methods for predicting ball mill and rod mill energy requirements that provide an accurate measure of ore grindability [4.9].

Conventional crushing and grinding circuits can be designed confidently on the basis of grindability data developed during small scale batch or locked cycle tests. For autogenous or semiautogenous grinding, however, the decision on how much test work is required is more complex [4.10].

MacPherson [4.11, 4.12] has developed a two part procedure for generating the grindability indices required to size autogenous and semiautogenous circuits. Preliminary design data can be developed from the following small scale tests:

- (a) Laboratory scale tests to produce Bond work indices for rod mills and ball mills,
- (b) Continuous small scale tests in a 45 cm (18 in) aerofall mill or equivalent device.

If the plant capacity is less than about 1000 t/d the data from these small scale tests will, in most instances, be adequate for the design of the commercial plant. The plant will grind ore at a reasonable cost, but initially may not be the most efficient.

TABLE 4.1. COST AND RISK ASSOCIATED WITH AUTOGENOUS AND SEMIAUTOGENOUS GRINDING TEST WORK (DIRECT LABORATORY COSTS ONLY)

Type of test work	Size of sample of each ore type	Cost <sup>a</sup> (US \$)	Risk level	Primary mill motor horsepower contingency (%)
Empirical calculations and scale-up from bond work indices (crushing, rod mill and ball mill)	35 kg	2 200	High	25
Small scale continuous testing (45 cm diameter mill)	136–227 kg	1 700	High to medium	N/A
Batch testing (1.8 m diameter mill)	2 t	3 300	Medium	15–20
Large scale continuous testing (1.8 m diameter mill)	30 t	22 000	Low	10

<sup>a</sup> 1986 costs adjusted to 1991.

For larger operations a pilot plant programme is readily justified to ensure that an efficient grinding circuit can be engineered. Table 4.1 shows the costs as of 1986 and the risks estimated by Barratt and Allan [4.10] for various levels of test work.

#### 4.2.4. Circuits and equipment

Many uranium operations have used conventional crushing and grinding circuits. One major modification in recent years has been the adoption of autogenous or semiautogenous systems that combine part or all of the crushing and grinding operations in one unit.

Approximately 65% of the mills constructed prior to about 1980 used conventional crushing and grinding circuits, and 22% had adopted semiautogenous grinding systems [4.13]. The remainder used various types of impact crushers. Nearly all of the mills constructed since 1980 have installed some form of semiautogenous grinding system.

#### 4.2.4.1. *Conventional crushing and grinding*

Conventional crushing and grinding systems have included both two and three stage crushing followed by various combinations of rod milling and ball milling [4.14]. Pebble mills have proven successful for second stage grinding in both conventional and autogenous grinding circuits. They both reduce liner wear and eliminate the introduction of grinding steel that consumes both acid and oxidant in the leaching circuit.

#### 4.2.4.2. *Wet autogenous grinding*

In the United States of America production of uranium concentrates were, until 1971, controlled by the Government through contracts with the various privately owned companies. Some mills received ore from as many as 100 small individually owned mines. Strict control over the accountability of the uranium was enforced through approval of the plant flow sheet prior to mill construction. In every case the ore from each mine had to be weighed in the trucks that brought the ore to the mill. Moisture samples were taken from each truck load. The ore was then passed through elaborate sampling plants to ensure an accurate sample for the chemical determination of the uranium content. The metallurgical balance for the mill as well as the payments to individual mine owners were based on these weights and analyses.

The Government contracts ended in 1971. As a result of this change, the companies had more latitude in mill design. For example in 1971 the Pathfinder Mines Shirley Basin, Wyoming, operation installed a semiautogenous grinding circuit capable of reducing mine run sandstone ore to grain size. This 14 ft × 5 ft (4.3 m × 1.5 m) mill used a 10% charge of 15 cm diameter steel grinding balls. Ten US mills have used a wet semiautogenous grinding process on sandstone ores. The dust and associated radiation hazards associated with the previously used multistage crushing and dry sampling system were essentially eliminated.

Wet semiautogenous mills have also been installed in the grinding circuits of mills treating quartz pebble conglomerates and unconformity related ores in Canada. These operations include the Denison mill in the Elliot Lake area of Ontario, together with the Key Lake and Rabbit Lake plants in Saskatchewan. All of these mills operate in closed circuit with classification devices.

The Olympic Dam plant in Australia uses a primary autogenous mill that operates in closed circuit with a DSM screen (see Chapter 11). The screen oversize recirculates to the mill and the undersize feeds to secondary grinding in a ball mill. The Nabrelek mill in Queensland fed run-of-mine (ROM) ore directly to a grinding circuit consisting of a wet semiautogenous mill followed by a conventional ball mill.

#### 4.2.4.3. *Dry semiautogenous grinding*

Two semiautogenous dry grinding mills were placed in operation during the mid-1950s at the Uravan operations of the Union Carbide Corporation in the USA. These mills, which were approximately 16 ft (4.9 m) in diameter, prepared feed for both the vanadium salt roasting circuits and the direct acid leach system. The mills were equipped with integral air classifying systems for controlling the grind. Similar mills were also installed at the Rifle, Slickrock and Green River operations of Union Carbide.

Both the Somair and Cominak operations in Niger have also had semi-autogenous dry grinding systems installed (see Chapter 16). Both the Uravan and Niger operations treat sandstone ores.

### 4.3. BENEFICIATION

#### 4.3.1. Introduction

Historically deposits of uranium, in order to be considered economic, should contain at least 0.07% of  $U_3O_8$ , but grades lower than 0.07% can be profitably treated if they contain a valuable by-product [4.15]. Gold rich Witwatersrand conglomerates can be economically processed for uranium recovery, even though their feed grades are only in the vicinity of 0.025%  $U_3O_8$  [4.16]. Currently grades approaching 0.3%  $U_3O_8$  are required for a stand-alone operation depending on tonnage and mineralogy. As a possible alternative to reducing expenditure through by-product recovery, economic advantage can be achieved by increasing the scale of the operation. Thus, by processing ore at a rate of 35 000 t/d, the Rossing operation in Namibia is able to treat ore with a head grade of 0.035% profitably [4.17].

Preconcentration methods have been investigated for over 20 years, but there have been only limited commercial applications because of the difficulties posed by the finely disseminated nature of most uranium deposits. In general, low cost process routes such as the heap and in situ leaching methods are usually selected in preference to the preconcentration method, as the probability of achieving both a high recovery and a high concentration ratio is low.

#### 4.3.2. Preconcentration processes

The beneficiation of uranium ores prior to leaching will probably be undertaken with one, or all three of the following objectives in mind:

- (a) To enhance the feed grade with consequent economic advantages in terms of the increased uranium production from the installed mill capacity,

TABLE 4.2. SEPARATION CRITERIA AND RELATED PROCESS EQUIPMENT

Separation basis	Separatory devices
Radioactivity	Radiometric sorter
Optical properties	Photometric sorters
Size/shape	Screens, cyclones
Density	Dense media separators, tables, jigs, spirals, cones, etc.
Paramagnetism	Wet high intensity magnetic separators
Surface properties	Flotation

- (b) To remove minerals that will probably prove deleterious in the uranium leaching and/or recovery stages,
- (c) To produce clean tailings that can be rejected without causing environmental problems.

Preconcentration processes employ differences in properties such as radioactivity, size, shape, density and surface characteristics to separate the desired mineral. The selection of process equipment on the basis of various physical properties is illustrated in Table 4.2.

#### 4.3.3. Radiometric sorting

The fact that uranium ore emits natural  $\gamma$  radiation would appear to offer an almost unique opportunity for the detection and subsequent separation of uranium bearing rock from barren gangue. The problem is complicated, however, by the variable size of the crushed rock and the non-uniform uranium distribution within the rock particles. This requires a separate assessment of the uranium content of each rock prior to implementing a decision regarding acceptance or rejection. The assessment–decision–reaction process must also be sufficiently rapid to accommodate an economic rate of ore throughput.

Radiometric sorting is an efficient and low cost process. It is usually applied to ROM uranium ore after primary crushing. Radiometric sorting can be used for the removal of coarse waste particles either in existing mines or in new mines. The advantages are as follows:

- (a) The practice of selective mining, which is expensive and inconvenient to operate, can be partially improved.



- (b) The recovery and production of uranium can be increased for the same ore throughput as a result of the ability of radiometric sorting to remove the waste prior to feeding the ore to the uranium mill.
- (c) The amount of ore to be treated at a new mill can be substantially reduced because of the removal of a large volume of coarse waste, resulting in both capital and operating cost savings for the mill.
- (d) The range of variation of ore grade is reduced, which allows for a more accurate appraisal of the mill efficiency and the performance of individual unit operations.
- (e) Some deposits, which have ores of low grade, can be converted into exploitable resources; therefore the service life of established mines can be extended.
- (f) From the viewpoint of environmental protection, large particles of waste rock are easier to dispose of, especially when the mill is located at the mine site.

Radiometric sorting has been widely used in South Africa [4.18], the former USSR [4.19–4.21] and China. Applications in other countries include the Mary Kathleen mill in Australia [4.22, 4.23], the Schwarzwald mine in the USA [4.24], the Lodève mill in France [4.25], and the Eldorado Beaverlodge and several other small mines in Canada [4.26].

#### 4.3.3.1. *Evaluation of sortability*

For the application of radiometric sorting there are three preconditions that should be satisfied:

- Sufficient heterogeneity of uranium minerals among ore particles,
- Relatively coarse fragmentation,
- Existence of radiometric equilibrium between uranium and radium in the ore.

(a) *Distribution of uranium minerals in mined ore.* The basic requirement for radiometric sorting is that the ore is sufficiently heterogeneous for particle separation. Knowledge of the grade distribution of ore particles is very important for preconcentration processes because the possibility of ore sorting and potential sorting performance are based on the grade distribution. In general, large marine sedimentary deposits are homogeneous with an evenly distributed uranium content; these deposits are therefore not suitable for sorting. The hydrothermal or vein type deposits are heterogeneous, owing to the distinct differences in grades, and are suitable for sorting.

To determine the grade distribution of a mined ore, it is necessary to have representative samples of several hundred ore particles. Each particle should be subjected to static  $\gamma$  radiation and mass measurements. However, the measurements may also be carried out on a radiometric sorter, i.e. the measurements of  $\gamma$  radiation

TABLE 4.3. RADIOMETRIC SORTING TEST RESULTS (SIZE FRACTION -150 +25 mm)

Range of uranium grades (% U)	Mean grade (% U)	Mass (%)	Recovery (%)	Accept <sup>a</sup>			Reject <sup>b</sup>			Accept $\lambda$ (%)
				Mass (%)	Grade (% U)	Recovery (%)	Mass (%)	Grade (% U)	Recovery (%)	
≤0.005	0.003	9.8	0.15	100.0	0.1920	100.00	9.8	0.0030	0.15	4.9
0.005-0.010	0.008	21.8	0.91	90.2	0.2126	99.85	31.6	0.0064	1.06	20.7
0.011-0.020	0.015	18.4	1.44	68.4	0.2777	98.94	50.0	0.0096	2.50	40.8
0.021-0.030	0.025	6.0	0.78	50.0	0.3745	97.50	56.0	0.0112	3.28	53.0
0.031-0.040	0.035	6.1	1.11	44.0	0.4221	96.72	62.1	0.0136	4.39	59.1
0.041-0.050	0.045	5.0	1.17	37.9	0.4840	95.61	67.1	0.0159	5.56	64.6
0.051-0.060	0.055	2.9	0.83	32.9	0.5510	94.44	70.0	0.0175	6.39	68.5
0.061-0.070	0.065	4.0	1.35	30.0	0.599	93.61	74.0	0.0201	7.74	72.0
0.071-0.080	0.075	1.9	0.74	26.0	0.681	92.26	75.9	0.0215	8.48	75.0
0.081-0.090	0.085	2.5	1.11	24.1	0.729	91.52	78.4	0.0235	9.59	77.2
0.091-0.100	0.095	2.3	1.14	21.6	0.804	90.41	80.7	0.0255	10.73	79.6
0.101-0.200	0.150	9.1	7.11	19.3	0.888	89.27	89.8	0.0381	17.84	85.3
0.201-0.300	0.250	1.9	2.47	10.2	1.547	82.16	91.7	0.0425	20.31	20.8
0.301-0.400	0.350	0.4	0.73	8.3	1.844	79.69	92.1	0.0439	21.04	91.9
0.401-0.500	0.450	0.6	1.41	7.9	1.919	78.96	92.7	0.0465	22.45	92.4
>0.50	2.040	7.3	77.55	7.3	2.040	77.55	100.0	0.1920	100.00	97.3

<sup>a</sup> Accept (calculated from bottom).

<sup>b</sup> Reject (calculated from top).

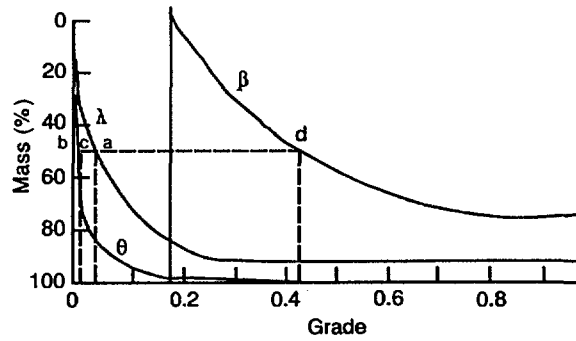

FIG. 4.1. Potential sortability curves:  $\lambda$ , sortability;  $\beta$ , accept;  $\theta$ , reject.

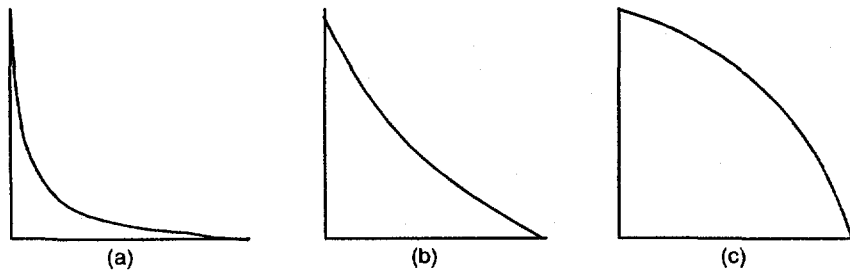

FIG. 4.2. Sortability curves for different types of ores: (a) sortability of ore is good; (b) sortability of ore is reasonable; (c) radiometric sorting not suitable as this is a very homogeneous ore.

TABLE 4.4. FRAGMENTATION OF ORE SAMPLES

Samples		Type of rocks	Mass of sortable fractions (%)
Number	Fraction (%)		
8	12.50	Coal, siltstone, pelite	9.6-35
13	20.32	Granite	36-50
36	56.25	Granite	50.1-70
7	10.93	Granite, siliceous shale	70
64	100.00		Average = 54.0

and 'shadow' area (corresponding approximately to the mass) of particles carried out when the rock is in movement. The  $\gamma$  counts and the mass for each particle are entered into a computer, which calculates the uranium grade of the particle. Particles with similar grades are allocated into a group. From the masses of various grade groups, the sorting performance of the ore can be predicted. An example of radiometric sorting test results carried out in China is given in Table 4.3 [4.27]. Sortability curves can be plotted using the data from Table 4.3 and potential sorting curves are shown in Fig. 4.1.

The sorting performance can be predicted from Table 4.3 or Fig. 4.1. If the cut-off grade is set at 0.03%, the mass percentage of the reject is 56% with the grade being 0.0112%. The mass percentage of the accept is 44% with the grade being 0.422%. The same results can be obtained from Fig. 4.1. The cut-off grade is set at 0.03% on the abscissa, the perpendicular from this grade (0.03%) meets curve  $\lambda$  at the point 'a'. The parallel line to the abscissa from point 'a' meets the ordinate, curve  $\theta$  and curve  $\beta$  at points 'b', 'c' and 'd', respectively. The length of the ordinate 'Ob' represents the mass percentage of the rejected material, the abscissa of point 'c' represents the rejected grade and the abscissa of point 'd' indicates the accepted grade. Appropriate ore sorting performance can be achieved by selecting different cut-off grades. The  $\lambda$  curve is sufficient for a qualitative assessment. Depending on the shape of the curve, the sortability characteristic of the ore can be demonstrated (Fig. 4.2).

(b) *Fragmentation.* Radiometric sorting is usually applied to ore with a particle size in the range of from 25 to 200 mm; therefore the proportion of the ore in this size fraction is a very important parameter. The greater the mass of the sortable fraction, the greater the potential waste rejection and thus economic benefit.

The mass percentage of the sortable fraction depends on the characteristics and hardness of the ore, the degree of fissuring and the parameters of explosion in mining. To determine the mass percentage of the sortable fraction, it is necessary to study the fragmentation of several tonnes of representative ore. The results obtained for dozens of ore samples taken in China are listed in Table 4.4. The fragmentation of most Chinese uranium ores makes them suitable for sorting. Those mines with a sortable mass fraction of less than 35% are probably uneconomical for sorting, unless the ore is very heterogeneous.

The influence of size fraction on sorting performance is best illustrated with an example. For ROM ore of 0.2% grade after sorting, 60% of the sorter feed is rejected with a grade of 0.034% and 40% of the sorter feed is accepted with a grade of 0.45%. When the mass percentage of the sorter feed varies there are large changes in the mass rejected and in the upgrade ratio; the results are compared in Table 4.5.

(c) *Radioactive equilibrium.* The uranium grade of every piece of rock can be estimated from the total  $\gamma$  activity of the ore. About 98% of the  $\gamma$  activity is emitted

TABLE 4.5. INFLUENCE OF SORTER FEED ON MASS SORTING PERFORMANCE

Mass of sorter feed (%)	Accept (%)			Reject (%)			Unsorted ore (%)		Accept + unsorted ore (%)		
	Mass		Grade	Mass		Grade	Mass on ROM basis	Grade	Mass on ROM basis	Grade	Upgrade ratio
	On ROM basis	Sorter feed basis		On ROM basis	Sorter feed basis						
70	28	40	0.45	42	60	0.034	30	0.2	58	0.32	1.60
30	12	40	0.45	18	60	0.034	70	0.2	82	0.236	1.18

from the radium group. As long as the uranium and radium are in radioactive equilibrium the  $\gamma$  activity represents the uranium grade. When the ore is in radioactive equilibrium, the ratio between uranium and radium masses is equal to  $3.4 \times 10^{-7}$ . The coefficient of radioactive equilibrium  $C$  (%) is

$$C = \frac{\text{Ra}}{\text{U}} \times \frac{1}{3.4 \times 10^{-7}} \times 100$$

Therefore, when the ore is in equilibrium,  $C = 100\%$ ; and when the ore is in non-equilibrium, the coefficient may be more or less than  $100\%$ . In general, if the coefficient of radioactive equilibrium does not exceed  $100 \pm 10\%$ , the correction is not necessary. In practice, absolute radioactive equilibrium in a uranium ore does not exist in nature. Variations may be classified into three categories:

- (1) The distribution curve of the radioactive equilibrium coefficient is regular. The curve has a single peak and is not symmetrical about the ordinate (Fig. 4.3(a)). If the deviation of the mean radioactive equilibrium coefficient is more than  $\pm 10\%$ , an appropriate correction must be made.
- (2) The distribution curve of the second kind of ore is similar to Fig. 4.3(b), but the curve is asymmetrical with respect to the ordinate. The peak of the curve may be on the left or right hand side of the ordinate (Fig. 4.3(b)). If the deviation of the mean radioactive equilibrium coefficient is more than  $\pm 10\%$ , an appropriate correction must be made.
- (3) The distribution of the radioactive equilibrium coefficient is random. This type of ore is not suitable for radiometric sorting (Fig. 4.3(c)). Test results indicate that uranium and radium are basically in equilibrium in most uranium ore bodies.

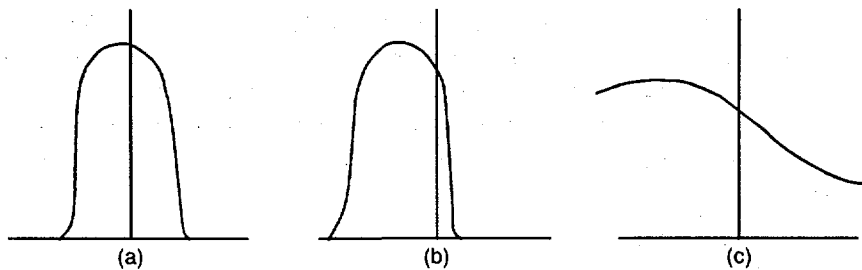

FIG. 4.3. Distribution curves of radioactive equilibrium coefficient.

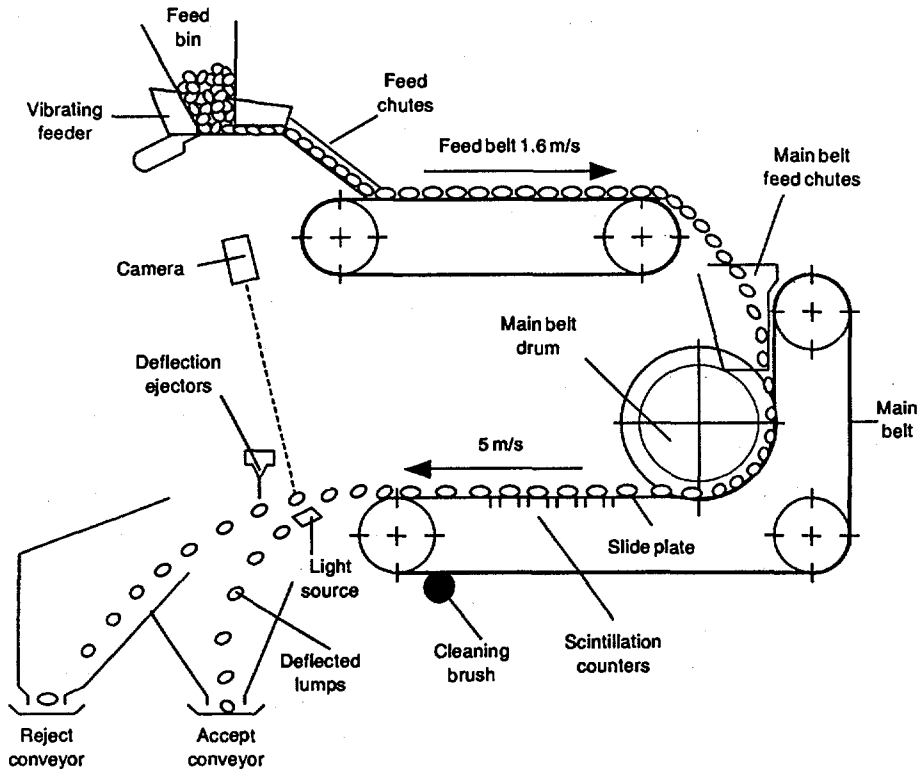

FIG. 4.4. Diagrammatic cross-section of sorter model 17.

#### 4.3.3.2. Mechanics of the sorter

The first radiometric sorter was developed in the late 1940s in Canada. Since then a large number of prototype and production machines have been designed and installed in many countries and regions, such as Canada, France, the former USSR, China, the former Czechoslovakia, Hungary, South Africa and Australia.

Although all sorters have different features and performances, they have the same operating principle and basically consist of four separate but interrelated subsystems:

- (a) the feed presentation system;
- (b) the radioactivity detection system;
- (c) the decision making system (processor, computer);
- (d) the separation system.

One typical radiometric sorter, 'Model 17' (the type RM radiometric sorter is similar) that has been developed by the Ore Sorters Company, is shown as an example in Fig. 4.4 [4.28, 4.29]. This sorter is able to accommodate between two and five channels of ore with a size range from 160 to 25 mm.

The sized fraction of the ore is fed onto the top belt in several channels. The particles are projected at approximately 1.5 m/s from the top belt. Gravity accelerates them to a velocity of 5 m/s, at which speed they are caught gently and tangentially by the vertical section of the L shaped belt.

The L shaped main belt transports the particles past scintillation counters located in a zone that is heavily shielded with lead to reduce the effects of background radiation. Each particle passes over a series of up to sixteen scintillation counters, the count information being collated and totalled in the electronic processor. The particles are then sequentially projected at 5 m/s.

The 'mass' of each particle is determined by means of measuring its 'shadow' with a scanning camera, and is then corrected by a factor that has been derived experimentally. Both the radiation and 'mass' are used to compute a probable uranium grade. This grade is compared with a pre-set cut-off grade and a decision made to accept or reject the particle. Separation is accomplished using a blast of air triggered by a microprocessor. This blast can be used to deflect, accept or reject the particle, depending on the mode that uses the lesser amount of compressed air.

The blast system itself consists of a manifold fitted with up to 50 high speed valves, each of which has its own driver circuit in the electronic processor. Thus, one or more valves can be used depending upon the particle size. Similarly, the duration of the blast can be varied.

The model 17 sorter is equipped with monitors to provide an immediate estimate of, for example, the percentage of belt occupation, cumulative throughput tonnage and feed grade. Events that will probably cause damage to the sorter result in an automatic shutdown with an indication of the location of the problem.

#### *4.3.3.3. Technical characteristics of a radiometric sorter*

The capacity, size and energy consumption (including the air consumption for separating one tonne of ore) of a radiometric sorter are usually given by the manufacturer in the technical documentation. Some parameters that influence the technical performance, such as the uniformity of the ore presentation, the background and the detection efficiency are now discussed further.

(a) *Uniformity of ore presentation.* Because of variations in ore shape, it is difficult to attain equally spaced particles. However, as the uniformity of ore presentation influences the sorting performance, a relative uniformity is required. If the particles are located in close proximity to each other, the  $\gamma$  radiation emitted by the preceding and following particles will give additional counts to the measured particle, resulting



in an overestimation of its grade. If the distance between particles is too large, the sorter throughput will be decreased.

(b) *Background.* The level of background radiation significantly influences the sensitivity of the sorting machine. In a mine, the background radiation may be very high. A high background decreases the sensitivity so that the counts emitted by small ore particles may be lower than the background, resulting in small particles being rejected as waste. Therefore detectors are heavily shielded by thick lead to reduce the background radiation and obtain the best signal-to-background ratio. General cleanliness is mandatory.

(c) *Detection efficiency.* The radioactivity from a 'standard' uranium ore measured at the centre of the detector is defined as the detection efficiency of the sorter. The detection efficiency is expressed in  $\gamma$  counts per second per gramme of uranium. The detection efficiency depends on the type and structure of the detector, as well as on the distance and radiation acceptance angle between the 'standard' and the surface of the detector. When using a Geiger-Müller counter, the detection efficiency is equivalent to several dozens of counts  $\cdot s^{-1} \cdot g^{-1}$  U. In a modern sorting machine in which scintillation counters are used the detection efficiency is nearly  $10^4$  counts  $\cdot s^{-1} \cdot g^{-1}$  U.

A sorter that has a high detection efficiency will produce superior results, as shown in Fig. 4.5. Curve 1 in Fig. 4.5 is an ideal sorting curve. Theoretically, when the cut-off grade is set at '5', all the ore particles with a grade lower than '5' are rejected and particles with a higher grade are accepted. However, because of the random nature of the radiation, an ideal separation cannot be achieved.

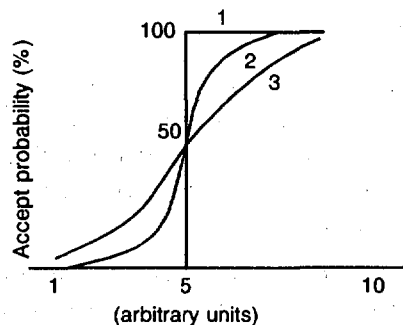

FIG. 4.5. Characteristic ore sorting curves: 1, ideal; 2, high detection efficiency; 3, low detection efficiency.

The characteristic curve for sorters with a high detection efficiency is close to the ideal curve (see curve 2 in Fig. 4.5). In this case, a few particles with grades lower than '5' are accepted and a few particles with grades higher than '5' are rejected. In sorters having a low detection efficiency (see curve 3 in Fig. 4.5), the percentage of incorrect sorting is significant.

In summary, the sorter efficiency is an important factor in the comprehensive evaluation of a sorter. Because of the random nature of the radiation, the difficulty in retaining a uniform separation between particles and the accuracy of the motion of the blast valve, the radiometric sorter cannot attain an efficiency of 100%.

The equation for calculating the sorter efficiency as a percentage is:

$$\eta = (A_s/A_f) \times 100$$

where  $A_s$  is the mass percentage of the reject from the sorting operation and  $A_f$  is the mass percentage of the reject in the sorter feed. In industrial applications the sorter efficiency varies approximately from 50 to 90%.

#### 4.3.3.4. Applications

Operations using radiometric sorters can be classified into three types of applications:

- (1) *Sorting of uranium ore.* This is the main application of radiometric sorters. ROM material is separated into accept and reject, or sometimes high grade and low grade products.
- (2) *Sorting of gold ore.* In certain South African deposits gold is found in close association with uranium. The gamma emission from uranium can be used as a tracer to indicate the presence of gold. In recent years eight radiometric sorting plants have been built in South Africa.
- (3) *Sorting of uneconomical material.* Some uneconomical uranium resources, for example waste dumps, may be successfully upgraded with the aid of a radiometric sorter. The accepted product will be available for subsequent treatment.

Some radiometric sorting plants, including several no longer in operation, are listed in Table 4.6 [4.30–4.38]. More specific details are discussed below.

#### 4.3.3.5. Sorter performance

- (a) *South Africa.* The nature of uranium and gold deposits in Witwatersrand conglomerate ore usually ensures that the relatively complete removal of uranium

TABLE 4.6. LIST OF RADIOMETRIC SORTING PLANTS

	Location	ROM grade % U (Au g/t)	Size fraction (mm)	Mass unsorted ore (%)
USA	Schwarzwalder, Colorado-Utah	0.356	-150 +25	—
	United Nuclear Corp., New Mexico			
Former USSR		0.09	-200 +25	38
Canada, Cenex Uranium City		0.04-0.10	-100 +25	30-40
Australia, Mary Kathleen		0.10	-200 +40	45-50
France, Lodève		0.25	-90 +30	60
South Africa	Val Reefs	0.0125 (2.4)	-115 +65	—
	Welkom	0.074 (3.4)	-75 +50	—
	Buffelsfontein	0.005-0.020 (5-10)	-65 +25	
	Western Deep levels	0.004-0.012 (10-15)	-65 +25	
	West Rand Consolidated	>0.02 (1-5)	-65 +25	
	F.A. Saaiplaas	0.005-0.020 (1-5)		
	Haartebeestfontein	0.005-0.020 (10-15)		
China	Western Holding	0.005-0.020 (5-10)		
	Mine 'A'	0.159	-250 +50	75
	Mine 'B'	0.096	-250 +50	55

Accept + unsorted ore			Reject			Status
Mass (%)	Grade (%) (g/t)	Recovery (%)	Mass (%)	Grade (%) (g/t)	Recovery (%)	
75.5	0.470	98.98	25.0	0.015	1.02	Two MKVIA type sorters
						One M17 sorter
66.3	0.130	95.4	33.7	0.012	4.6	
45-75	0.11-0.18	—	25-55	<0.03	—	Closed
72.5-69.75	0.13	94.5-93.8	27.5-30.25	0.02	55-6.2	Closed
85	—	98	15	0.012-0	2	One M17
53.6	0.0220 (4.25)	93.9 (94.7)	46.4	0.0017 (0.28)	6.1 5.3	One M 17
14.3	0.0338 (15.2)	65.3 (63.8)	85.7	0.0030 (1.44)	34.7 (36.2)	One M 17
40			60	0.0045 (0.69)		Four RM type sorters
20-25	0.008-0.04		75-80	0.0015-0.002		Five M 17 type sorters
21-25	0.06-0.12		75-79	0.004-0.085		Two M 1
						One M 1
						One M 1
						One RM
80.5	0.195	98.75	19.5	0.0102	1.25	One 201
72.07	0.128	96.45	27.93	0.012	3.55	Belt type 5421 type

bearing rock will produce a satisfactory recovery of gold as well. Some examples of radiometric sorting are:

- (i) Western Deep Levels — model 17  
5 2-channel machines sorting  $-150 +65$  mm,  
4 5-channel machines sorting  $-65 +25$  mm,  
reject material assays of less than 20 ppm  $U_3O_8$ ;
- (ii) Val Reefs — model 17  
experiments in sorting  $-115 +65$  mm to produce a tailings of less than 15 ppm;
- (iii) Welkom Gold Mine — model 17  
1 4-channel machines sorting  $-75 +50$  mm fraction of low grade material;
- (iv) Buffelsfontein Gold Mine — RM161  
4 6-channel machines sorting  $-50 +25$  mm,  
reject material assays of less than 25 ppm  $U_3O_8$ .

(b) *Canada.* The Cenex Mine in Saskatchewan provided ore for the Eldorado Mill on a contract basis for a short period in 1979. The installation of a radiometric sorter increased the grade of ore sent to the mill from 0.18 to over 0.3%  $U_3O_8$ . By enhancing the grade of the limited tonnage accepted by the mill, the milling costs were reduced by more than US \$2 per kg  $U_3O_8$ .

Test work performed on the Uranium City, Saskatchewan mill feed suggested that ore containing between 0.04 and 0.10%  $U_3O_8$  could be upgraded by 200 to 400% using radiometric sorting. The reject fraction, comprising between 40 and 80% of the feed weight, contained about 0.03%  $U_3O_8$ . The unsorted fines fraction amounted to some 30 to 40% of the total feed stream. This operation was terminated after several months because of inadequate ore reserves.

(c) *The former USSR.* Ore is sorted with a practical upper limit on size of  $-300 +150$  mm and a lower limit of  $-25 +5$  mm. The ore sorted is maintained within a narrow size range with a ratio of upper/lower sizes of 1.5 to 2.0, which is achieved by screening. The production rates of the separators are given in Table 4.7.

Up to 35% of the feed is rejected as waste rock. Two types of separators have been described: one uses a cone distributing device to arrange the particles in a single file for discrimination on an inclined chute, the other uses a vibratory tray distributor to set the particles in line on a stabilizing belt, with the particles sorted in free fall and rejected by a compressed air blast or water spray. In one example with ore containing 0.09% U, sorting in the various classes of machine gave a concentrate with an average grade of 0.13% U, with 95.4% recovery of uranium and 33.7% of the feed rejected [4.20, 4.21].

(d) *Australia.* Four basic Kelly and Hutter model M6 radiometric ore sorters were commissioned at the Mary Kathleen Mill during the first stage of operations in 1960. When the mill was reopened in 1976, an additional two RTZ M17 model sorters were installed, as part of a major mill upgrade [4.23].

After primary crushing,  $-25$  mm ore was removed, and the oversize washed to remove fines with a relatively high uranium content, before rescreening at 140 mm. The  $+140$  mm fraction was fed to the M6 sorters, and the undersize to the M17s. Typical results for the sorters are presented in Table 4.8.

The use of the ore sorters increased the uranium throughput of the mill and also reduced the level of one of the principal acid consumers, carbonate. However, phosphate, another significant acid consumer, was preconcentrated because of its close association with the uranium mineralization.

TABLE 4.7. PRODUCTION RATES OF SEPARATORS

Separator classification	Production rate (t/h)
$-200 +50$ mm ore	40-100
$-50 +25$ mm ore	10-15
Fine class	5

TABLE 4.8. MARY KATHLEEN URANIUM SORTER RESULTS

Sorter	Run	$U_3O_8$ content ( $kg \cdot t^{-1}$ )			Upgrade factor (accept/feed)	Reject weight (%)	Uranium recovery (%)
		Accept	Reject	Feed			
M6	1	3.69	0.24	2.24	1.65	42.0	95.5
	2	2.28	0.10	1.07	2.13	55.6	94.8
	3	1.49	0.07	0.97	1.54	36.7	97.3
M17	1	2.69	0.28	1.38	1.95	54.5	88.9
	2	2.12	0.15	0.82	2.59	66.0	87.9
	3	2.66	0.23	1.25	2.13	58.0	89.3

#### 4.3.4. Photometric and conductimetric sorting

In the early 1970s, the United Kingdom Atomic Energy Authority developed an optical system, based on fibre optics, which differentiated between opaque, uranium bearing particles and translucent grains of quartz or quartzite [4.39]. Scanning laser light sorters have been developed by Ore Sorters Ltd [4.40, 4.41]. A model 13 unit was operated for over four years at Doornfontein Gold Mines, South Africa. A more advanced model 16 was capable of sorting 60 t/h of 20 mm feed.

A sorter that separates on the basis of the electrical conductivity was tested on Rio Algom Nordic ore [4.42]. In this application the selectivity was similar to that of radiometric sorting, but because the ore had to be washed and dried it was eliminated on the basis of operating costs.

#### 4.3.5. Separation on the basis of size and shape

Uranium ores in which the metal is usually finely disseminated would appear to be unsuitable for physical separatory processes [4.43]. However, in many uranium deposits, uranium minerals and gangue have different values of hardness and fragility. After crushing, screening and grinding, different sized fractions may have different uranium grades. This characteristic can be utilized for ore beneficiation. The distribution of uranium in the ground material of one South African ore (Witwatersrand) is shown in Table 4.9 [4.44].

It is evident from Table 4.9 that 88% of the uranium could be recovered from 71.9% of the feed mass, but the screening of large tonnages of pulp on a comparatively fine mesh would be technically demanding and would afford little saving in

TABLE 4.9. DISTRIBUTION OF URANIUM IN WITWATERSRAND CONGLOMERATE ORE

Size fraction ( $\mu\text{m}$ )	Mass (%)	$\text{U}_3\text{O}_8$ grade (ppm)	$\text{U}_3\text{O}_8$ distribution (%)
+150	0.5	318	0.6
+106	17.7	124	7.3
+75	9.9	126	4.1
+53	11.5	171	6.6
-53	60.4	404	81.4

comminution costs. The screen separation of crushed Witwatersrand ore into high and low grade fractions has been accomplished using 3 and 19 mm screens, and this has permitted some 30% of the feed weight containing about 60% of the uranium to be processed for the recovery of both gold and uranium. After processing of the balance for gold alone the tailings have been stockpiled until such time as a higher uranium price might justify their retreatment [4.45].

In some conglomerates, sandstone grains are relatively coarse and uranium minerals are the cementation material occurring between barren sand grains. For this type of ore, attrition grinding may promote separation, but as power requirements are quite high, this process is seldom used in industry.

Sizing of an Australian vein type ore crushed to  $-6$  mm showed that uranium was concentrated by a factor of 1.3 to 4.5 in the  $-45$   $\mu\text{m}$  fraction, with this trend being more apparent in weathered, than in primary ore. Unlike the conglomerate ore, 60–80% of the uranium was contained in the size fraction above 500  $\mu\text{m}$ .

#### 4.3.6. Separation on the basis of gravity

The concentration of uranium by gravimetric methods is limited to those ores in which uranium minerals are relatively coarse and are capable of resisting breakage and sliming or association with other minerals which may be separated themselves from gangue by a density differential.

The uranium minerals suitable for density separation are mainly uraninite and pitchblende. The secondary uranium minerals, even when they exhibit a high specific gravity, are usually too soft to avoid sliming. Gravity concentrators can be subdivided into the following categories:

- (a) Devices that enhance the separating forces acting on particles of different shape, size and density in a film of flowing water, for example spirals, plane tables and Reichert cones;
- (b) Devices that enhance the differential settlement and transportation potential of various mineral particles, for example jigs and shaking tables;
- (c) Devices that employ a fluid medium with an effective density intermediate between that of the desired minerals and the worthless gangue in order to achieve a separation of the two, for example drum and cyclone type heavy media separators.

Although the comparatively fine size of most comminuted uranium minerals precludes their concentration as such, advantage can be taken of the fact that the uranium is often associated with heavy minerals that are liberated in a coarse size range. For this reason the uranium associated with pyrites and other heavy minerals in Witwatersrand conglomerate ore can be recovered by gravimetric separation methods [4.46–4.48].



TABLE 4.10. BENEFICIATION RESULTS FROM COPPER FLOTATION TAILING

Products	Mass (%)	Grade (%)	
		U <sub>3</sub> O <sub>8</sub>	ZrO <sub>2</sub>
Uranium concentrate	0.078	3.133	72.46
Zirconium concentrate	0.285	0.139	46.86
Magnetic concentrate	1.925	0.009	0.0
Tailing	97.712	0.00156	0.089
Feed	100.00	0.004067	0.281

#### 4.3.6.1. Static flowing water separators

Various spiral concentrator devices have been developed in which the pulp is made to flow downwards through three to six turns of a spiral trough. A combination of drag, gravity, frictional and centrifugal forces causes the heaviest particles to find their way rapidly to the bottom of the trough where the fluid velocity is at a minimum and the frictional retardation is at a maximum.

The test work on Witwatersrand conglomerate ores has shown that the spiral concentrator can recover some 95% of liberated pyrites particles in the size range from 53 to 212  $\mu\text{m}$ . However, the overall recovery of uranium was inadequate when using spirals as roughers and shaking tables as cleaners [4.49].

A Reichert cone separator consists of a number of conical surfaces, each provided with annular slots for the removal of a heavy mineral concentrate. When tested on Witwatersrand ore, a single cone recovered 95% of the gold, 85% of the pyrites and 60% of the uranium, but a concentration ratio of only 2.5 was achieved [4.50].

The Reichert cone is used in conjunction with shaking tables and a magnetic separator to enrich the uranothorianite content of the tailing (about 0.004% U<sub>3</sub>O<sub>8</sub>) from the Palabora copper flotation plant [4.51]. The results are given in Table 4.10.

The uranium recovery in the uranothorianite concentrate was 59.8%. The zirconium recovery in baddeleyite was 67.6%.

#### 4.3.6.2. Mechanical gravitational separators

Two noteworthy separating devices in this category are the jig and the shaking table. The jig is usually applied to the treatment of material in the size range from 25  $\mu\text{m}$  to 75  $\mu\text{m}$ , while the table is used for the finer size range between 3000 and 15  $\mu\text{m}$  [4.52].

Gravimetric concentration of pitchblende ore by jigs and tables was used from 1933 until 1960 at the Eldorado Port Radium operation in Canada. The recovery of uranium was only about 70%, producing a concentrate grading of about 15% U. A gravitational concentration of pitchblende ore with the shaking table method was used in China in the 1970s. The head grade of ore was 1.12% U. The uranium concentrate represented 1.75% of the original feed mass and contained 35.7% U and 5.2% S. The uranium recovery was 55.7%. The concentrate was then treated by the flotation technique. The final concentrate, containing 40.4% U and 0.7% S, was treated to extract radium. The tailing was leached for uranium.

Jigs have been used to recover heavy minerals from milled Witwatersrand conglomerate ores at mines such as the Durban Deep, the Western Areas and the West Rand Consolidated. Pyrites recovery was, however, only in the region of 40 to 50%, while the recovery of uranium was only about one half of that of the pyrites [4.45].

The shaking table can act as a relatively efficient concentrator when equipped with a suitable deck material and riffle configurations appropriate for the characteristics of the ore being treated. Alterations in the characteristics of the feed material cause the concentrate band to shift in relation to the product splitters with a consequent loss in grade or recovery. Gravimetric separation was used to upgrade the 'low grade' fraction of the rich Cliff Lake deposit during the first operational phase [4.53]. The average uranium content of the deposit was about 7%, with the uranium mineralization being entirely uraninite and pitchblende allied with a matrix of chlorites. The gravimetric separation circuit, which involved jigging and tabling the ore according to its size, treated the 0.3–20% U portion of the as-mined ore. The fraction above 20% bypassed this circuit. Treatment produced concentrates containing more than 30% uranium, with tailings of about 0.8%. Recoveries were 80 to 85%.

The ore was first screened at 6 mesh; the oversize was sent to a Yuba type of jig while the undersize was sent to a Denver mineral type of jig. To avoid the carry-over of clayey particles the feed to the Denver jig was cycloned to remove the 200 mesh fraction. The concentrates from both jigs reported to the grinding circuit, while the tailings were again screened at 20 mesh. The +20 mesh fraction was stored for processing at a later date, while the –20 mesh fraction was screened and fed to 2 sets of concentrating tables, one set for the sands (–20 +100 mesh), and one set for the fines (–100 mesh). Each set had two tables, the second one processing the middlings from the first.

The concentrates from the tables entered the grinding circuit and the tails were thickened and stored for processing at a later date.

#### 4.3.6.3. *Heavy media separation*

A relative density difference of one tenth of a unit is considered adequate to separate ore from waste in heavy media processing. In the case of conglomerate ores this requirement would be satisfied with a pyrites content of some 8% [4.54].

The heavy media separation of ore and gangue can be accomplished in both cone and drum type separators as well as in a cyclone washer. Apart from its smaller size and hence space saving potential, the cyclone washer is unique in that separation occurs because of an effective differential increase in specific gravity of the particles compared with that of the circulating medium [4.56].

A heavy media cyclone washer has been applied to the beneficiation of Witwatersrand ores, and when operating at a relative density of 2.71 with a size fraction of 1.5–12.5 mm, some 78% of the uranium was collected in a concentrate comprising 24% of the feed mass, that is a concentration ratio of approximately 11. Cyclone washers using a ferrosilicon–magnetite medium have been installed at the Free State Saaiplaas (75 t/h) and Vaal Reefs (80 t/h) mines. Their float (reject) products are diverted to separate low grade leach circuits [4.45].

Other applications of heavy media separation to uranium ores have included:

- (a) *Streitberg Ridge*. An ore, with a head value of 0.055%  $U_3O_8$ , was separated to give a concentrate containing 70% of the uranium in 30% of the feed weight [4.56].
- (b) *Armchair Creek*. Ore with a head value of 0.1%  $U_3O_8$  provided a concentrate containing some 65% of the uranium in 35% of the feed weight [4.56].
- (c) *Uranium City*. Between 80 and 90% of the uranium was recovered in a concentrate equal to 25% of the feed weight [4.57].
- (d) *Elliot Lake*. Some 90% of the uranium was recovered in a concentrate comprising about 70% of the feed weight [4.58].

#### 4.3.7. Separation on the basis of magnetic susceptibility

Most uranium minerals are not suited for effective separation by magnetic methods because their magnetic characteristics are not sufficiently distinctive from the associated gangue constituents. However, some uranium bearing minerals are amenable to magnetic separation.

Experiments using wet high intensity magnetic separators on a Witwatersrand conglomerate residue showed that the recovery of uranium was particularly dependent upon particle size. Recoveries of up to 84% could be obtained in the size range of 106 to 32  $\mu\text{m}$  [4.59].

Wet, high intensity magnetic separators have now developed to a point where comparatively small paramagnetic and non-magnetic particles can be separated while suspended in a fluid. A typical wet high intensity magnetic separator (WHIMS) consists of an annular box filled with a ferromagnetic matrix and provided with a drive to rotate this material through one, or more, magnetic fields with intensities often in excess of 20 000 G [4.60]. A shortcoming is the tendency for the orifices to become blocked by wood chips and ferromagnetic particles. This problem has

been largely overcome by means of a device that permits continuous removal of the spherical matrix material from a WHIMS separator for cleaning.

Laboratory and pilot plant tests using WHIMS on Elliot Lake ore have also given promising results [4.61]. The ore contained pyrites, which had to be removed to prevent acid generation in the disposed tailings. A second aim of the work was to produce a 'discardable' fraction low in radionuclides. The preferred flow sheet consisted of pyrites flotation and high gradient magnetic separation on the deslimed flotation tails. The preconcentration procedures resulted in the following recoveries in the combined pyrite and radioactive concentrates, which assayed in the range 0.24–0.32% U: 98–99% of the pyrite, 95–98% of the U, 95–98% of the Ra and 90–92% of the Th.

These concentrates comprised 30–40 wt% of the ore. Dry magnetic concentration tests on davidite ore from Streitberg Ridge (in Australia) with a head value of 0.055 to 0.065%, indicated that some 60% of the uranium could be recovered in a concentrate comprising 30% of the feed weight; or some 90% in 70% of the feed weight [4.62].

In a low grade uranium and thorium mine in China the uranium head grade was 0.045–0.05%, and the thorium grade was 0.15–0.17%. This ore was 'refractory' and the acid consumption was high (250 kg H<sub>2</sub>SO<sub>4</sub> per tonne of ore). The main uranium bearing mineral was rinkolite, which has a moderate magnetic susceptibility. With the aid of dry, high intensity magnetic separation about 30% of the feed mass was rejected, in which the uranium grade was 0.008–0.013%. The thorium grade was 0.06%. The loss of uranium in the reject was about 5% [4.63].

#### 4.3.8. Flotation

Many research organizations have investigated the flotation of uranium minerals and ores. Test work on a variety of ores has shown that for suitable feed materials 70–95% recovery of uranium can be obtained with an acceptable concentration ratio. However, flotation as a preconcentration step has never progressed beyond the pilot plant stage, because it has seldom been possible to produce a discardable tailings.

Flotation, however, has been successfully applied in a number of operations as a means of separating objectionable constituents, such as sulphides, carbonates and carbonaceous minerals, from the mill feed. It is well known that a high sulphide content will consume carbonate in an alkaline leaching circuit.

At Beaverlodge, Canada, the average ore received by the mill assayed 0.2–0.5% U<sub>3</sub>O<sub>8</sub> and also contained 5% calcite and 0.3% pyrites. As such, the ore was not immediately amenable to either acid or carbonate leaching. Flotation was carried out in carbonate solution to float the pyrites. The final concentrate contained about 50% pyrites and up to 0.4% U<sub>3</sub>O<sub>8</sub> and was acid leached to dissolve the uranium. Uranium in the acidic pregnant solution was precipitated with Mg(OH)<sub>2</sub> to

produce a crude product and this product was then pumped to the carbonate circuit for eventual recovery [4.64].

Witwatersrand gold mines (South Africa) contain pyrites and uranium. The gold is closely associated with pyrites and uranium. Flotation processes are used in Witwatersrand in the milling circuit of four plants. The mass percentage of flotation concentrate is less than 10%, in which up to 80% of the gold and 25% of the uranium are contained. After regrinding the concentrate, a higher recovery of gold and uranium can be obtained by using cyanidation. Flotation processes are used for obtaining pyrite from the residue at six plants. In these cases, the feed materials are initially treated with cyanide for the recovery of gold and then acid leached for the recovery of uranium [4.65, 4.66].

An alternative means of recovering the uranium minerals is through the rejection of gangue likely to consume lixiviant. In the case of a Zambian sandstone ore some 80% of the carbonate minerals were rejected with a loss of less than 10% of the  $U_3O_8$ . Soda ash was used to adjust the pH value of the pulp to 9.4, and between 0.5 and  $0.6 \text{ kg} \cdot \text{t}^{-1}$  of R633 was added as a non-carbonate mineral depressant. The collector consisted of  $0.6 \text{ kg} \cdot \text{t}^{-1}$  of palm kernel oil, three parts of which were mixed with one part of Caltex fuel oil and TEB used as a frother [4.67].

Ore from the Olympic Dam deposit in South Australia contains uranium that is very closely associated with copper sulphide minerals. Flotation is used to separate the sulphides from the uranium. The concentrate and tailings containing 18 and 0.1% sulphur, respectively, are produced from ore containing about 1% sulphur, with more than 90% of the uranium going to the tailings (Section 5.1). The concentrate is smelted to produce blister copper and the tailings leached to recover uranium. The  $SO_2$  off-gas from the smelter is used to produce sulphuric acid for leaching of the tailings [4.68].

The details of the other test work done on the flotation method are summarized in the first edition of this technical report.

#### 4.4. ROASTING

##### 4.4.1. Introduction

Roasting can improve the amenability of some uranium ores to processing by altering the chemical composition or the physical characteristics of the ore. Uranium processing operations have used roasting to solubilize vanadium, eliminate sulphides, oxidize uranium, eliminate carbon and dehydrate clays to improve solid-liquid separations. Improvements in hydrometallurgical processing technology have essentially eliminated the economic advantages once offered by roasting. It is prudent, however, to explore the effects of the roasting procedures during the bench scale investigation phase of a process development study.

#### 4.4.2. Roasting chemistry

The stability of the uranium oxide system varies with temperature. Studies have defined the following general stability pattern for this oxide system [4.69–4.72]:

- (a)  $\text{UO}_3$  is generally stable in air at temperatures up to the 450–600°C range;
- (b) Above this temperature range  $\text{UO}_3$  starts to convert to  $\text{U}_3\text{O}_8$ .
- (c) At temperatures between 650 and 900°C  $\text{U}_3\text{O}_8$  is the stable uranium oxide in air;
- (d) Above 900°C in air  $\text{U}_3\text{O}_8$  starts decomposing to  $\text{UO}_2$ , but the decomposition is not complete until almost 2000°C.

The dioxide  $\text{UO}_2$  is a base, while the trioxide  $\text{UO}_3$  has amphoteric properties. Therefore  $\text{UO}_3$  can form uranyl salts (such as  $\text{UO}_2\text{SO}_4$ ) with acids, and uranates (such as  $\text{Na}_2\text{UO}_4$  or  $\text{Na}_2\text{U}_2\text{O}_7$ ) with alkaline materials. The intermediate oxide  $\text{U}_3\text{O}_8$  may be partly converted to uranates by the reaction with metal oxides and completely converted in the presence of an oxidant.

If siliceous materials are present during the roasting operation, uranium may react to form silicates. Reducing conditions promote the formation of these compounds [4.73].

#### 4.4.3. Roasting processes

Roasting processes have been used in uranium mills for:

- (a) the separation of vanadium and for vanadium recovery,
- (b) the oxidation of uranium and sulphide,
- (c) carbon removal,
- (d) the dehydration of clay minerals.

##### 4.4.3.1. Vanadium solubilization

The salt roasting of carnotite type ores has been used primarily to produce water soluble vanadium compounds and to separate uranium from vanadium.

The classical salt roast process consists of the following steps [4.74–4.76]:

- (a) The ore is dry ground to a size of about –10 mesh and mixed with 6 to 10% of  $\text{NaCl}$ ;
- (b) This mixture is roasted at 825 to 850°C under oxidizing conditions for 1 to 2 h in a multiple hearth roaster;
- (c) The roast calcine is cooled rapidly, preferably by quenching in the water leaching solution;

- (d) After a short leaching period (less than 1 h in an agitated leaching system), a solid-liquid separation is made;
- (e) The liquid stream is pumped to the vanadium recovery circuit, and the washed solids are fed to the acidic uranium leaching circuit.

The salt roast reactions are complex, but the following are believed to predominate [4.77]:

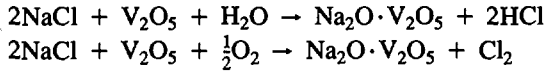

The sodium vanadate is believed to react with uranium compounds to form sodium uranyl vanadate.

In the correct salt roasting conditions, from 70 to 80% of the vanadium becomes soluble in water; essentially none of the uranium converts to a water soluble form. Uranium extraction in the subsequent acid leach is not improved by salt roasting. Even under optimum roasting conditions the uranium extraction may be inferior to that obtained by direct acid leaching of the raw ore.

In the USA the salt roasting process has been replaced by hydrometallurgical processing. The raw ore is hot leached at 80 to 90°C. Both uranium and vanadium are taken into solution and subsequently separated by solvent extraction.

#### 4.4.3.2. Oxidation

Roasting in air can promote the oxidation of tetravalent uranium, such as that present in uraninite minerals, to the hexavalent state. In addition disseminated pitchblende is often associated with various sulphide minerals. Roasting can open up these ores and enable leaching solutions to contact pitchblende locked in the sulphide matrix. Roasting at about 500°C usually produces the maximum porosity [4.78]. If the temperatures exceed 600 to 650°C, however, insoluble uranium silicate complexes can form. When sulphide minerals are present in an ore, the environmental effect of SO<sub>2</sub> or SO<sub>3</sub> in the roaster off-gases must be carefully considered.

#### 4.3.3.3. Carbon removal

The carbon contained in lignite and asphaltic ore must usually be removed in order to obtain acceptable levels of uranium. Roasting can also significantly improve the physical handling characteristics of the leach slurries. Normally, temperatures of around 450°C are sufficient to remove the carbon. Again, however, roasting temperatures above 600 to 650°C can tie up the uranium [4.79].

#### 4.4.3.4. Dehydration

Secondary and tertiary uranium deposits often carry significant amounts of clay minerals, such as montmorillonite, that can interfere with the settling and filtering characteristics of the leach slurries. Prior to the adoption of effective flocculants such as guar gum or the polyacrylamides, roasting was used to remove the water of hydration from the clays, and thereby improve the physical characteristics of the leach pulps. The roasting temperatures were in the 300 to 600°C range.

#### 4.4.4. Roasting equipment

Roasting operations in uranium mills have used both multiple hearth roasters and rotary kiln units. Nearly all salt roasting operations used multiple hearth roasters of the Skinner type. An exception was the New Rifle Mill of the Union Carbide Corporation, which used a rotary kiln unit [4.72].

Multiple hearth roasters have a number of advantages over rotary kilns for salt roasting, including the following:

- (a) The temperature on each hearth can be controlled individually; this permits a closer control of the roast temperature profile.
- (b) The multiple hearth roaster is better able to cope with the semiplastic ore stage encountered during the initial part of the roasting period.
- (c) Gas velocities are lower through the multiple hearth units; this reduces the dusting problem.

Primary disadvantages of multiple hearth roasters include higher capital and operating maintenance costs. Most oxidation and dehydration roasting operations have used conventional rotary kilns.

All roasting operations must have dust collectors such as cyclones or bag houses to remove particulate matter from the stack gases. If sulphides are present, SO<sub>2</sub> removal will be required. Salt roasting off-gas systems have often used wet scrubbers and HCl recovery units.

### REFERENCES

- [4.1] ARMSTRONG, A.T., "Radium Hill", Proc. 8th Commonwealth Mining Cong., Australia, 1965, (1965) Ch. 9.
- [4.2] TUNLEY, T.H., NEL, V.W., "The recovery of uranium from uranothorianite at the Palabora Mining Company Limited", Solvent Extraction (Proc. Int. Conf. ISE, Lyons, 1974), Vol. 2 (1974) 1519-1533.
- [4.3] PENDREIGH, R., The second last grain of uranium, Nucl. Act. **19** (1978) 2-8.



- [4.4] WILLS, B.A., Mineral Processing Technology, 4th edn, Pergamon Press, Oxford and New York (1988) 204-205.
- [4.5] VON RITTINGER, P.R., Lehrbuch der Aufbereitungs-Kunde, Ernst and Korn, Berlin (1867).
- [4.6] KICK, F., Des Gesetz des Proportionalem Widerstands and seine Anwendung, Felix, Leipzig (1885).
- [4.7] BOND, F.C., The third theory of comminution, Trans. AIME **193** (1952) 484.
- [4.8] HUKKI, R.T., The principles of comminution: An analytical summary, Eng. Min. J. **176** (1975) 106.
- [4.9] BOND, F.C., Crushing and Grinding Calculations, Bulletin 07R9235B, Allis Chalmers Co., Milwaukee, WI (1961).
- [4.10] BARRATT, D.J., ALLAN, M.J., Testing for autogenous and semiautogenous grinding: A designer's point of view, Miner. Metall. Processing (1986) 65-74.
- [4.11] MACPHERSON, A.R., A simple method to predict the autogenous grinding mill requirements for processing ore from a new deposit, SME-AIME Trans. **272** (1977).
- [4.12] MACPHERSON, A.R., Autogenous grinding 1987 — update, CIM Bull. **82** (1989) 75-82.
- [4.13] INTERNATIONAL ATOMIC ENERGY AGENCY, Significance of Mineralogy in the Development of Flowsheets for Processing Uranium Ores, Technical Reports Series No. 196, IAEA, Vienna (1980).
- [4.14] ROACH, R.J., "Comminution of uranium ores", Extractive Metallurgy of Uranium, (Lecture Notes, Short Course, University of Toronto, 1978), University of Toronto, Toronto (1978).
- [4.15] BOWIE, S.H.U., Global Distribution of Uranium Ores and Potential UK Deposits. Geological Aspects of Uranium in the Environment, Misc. Paper No. 7, Geological Society, London (1978) 12.
- [4.16] Ibid., p. 15.
- [4.17] NASH, J.T., Uranium geology in resource evaluation and exploration, Econ. Geol. **73** 8 (1978) 404.
- [4.18] SIMONSEN, H.A., BOYDELL, D.W., JAMES, H.E., "The impact of new technology on the economics of uranium production from low grade ores", Proc. 5th Ann. Symp. of the Uranium Institute, London (1980) 87.
- [4.19] Uranium Ore Processing (Proc. Advisory Group Mtg Washington, DC, 1975), IAEA, Vienna (1976).
- [4.20] SKOROVAROV, D.I., et al., "Processing of low grade uranium ores in the USSR", Uranium Ore Processing (Proc. Advisory Group Mtg Washington, DC, 1975), IAEA, Vienna (1976) 141-152.
- [4.21] SKRINICHENKO, M.L., et al., "The radiometric beneficiation of poor uranium ores", Nuclear Power and its Fuel Cycle (Proc. Int. Conf. Salzburg, 1977), IAEA, Vienna (1977) 365-375.
- [4.22] BAILLIE, M.G., THOMAS, J.A., "Planned changes in the Mary Kathleen treatment plant for future operations", Uranium Processing (Proc. AAEC Symp. Lucas Heights, Sydney, 1972), AAEC, Lucas Heights (1972) Paper VI.
- [4.23] BIBBY, P.A., "Preconcentration by radiometric ore sorting", paper presented at Australian Institute of Mining and Metallurgy Mill Operators Conf., Mt Isa, 1982.

- [4.24] SEIDEL, D.C., "Stored technology for possible use in uranium ore processing", Uranium Ore Processing (Proc. Advisory Group Mtg Washington, DC, 1975), IAEA, Vienna (1976) 79-89.
- [4.25] MICHEL, P., "Processing of low grade uranium ores", Uranium Ore Processing (Proc. Advisory Group Mtg Washington, DC, 1975), IAEA, Vienna (1976) 127-137.
- [4.26] GOW, W.A., RITCEY, G.M., The treatment of Canadian uranium ores: A review, CIM Bull. **62** (1969) 1330.
- [4.27] WANG, Shuhui, et al., Radiometric Sorting of Uranium Ore, Publishing House of Atomic Energy, Beijing (1988) 48.
- [4.28] SCHAPPER, M.A., Nucl. Act. **21** (1979) 11-15.
- [4.29] BOHME, R.C., WOLF, P., Mineral Processing (Proc. 14th Int. Congr. Toronto, 1982), Vol. II, 17-23.
- [4.30] WHITE, L., Eng. Min. J. **179** (1978) 11.
- [4.31] VAN DER SPUY, R.C.M., J. S. Afr. Inst. Min. Metall. **82** 2 (1982) 17-29.
- [4.32] S. Afr. Min. Eng. J. **91** (Sep. 1980) 119.
- [4.33] Min. Mag. (May 1982) 393-397.
- [4.34] Can. Min. J. **100** 8 (1979) 20.
- [4.35] GRENIER, J., et al., Ind. Miner. Mines Carr. Tech. **6** (1986) 259-265.
- [4.36] KEDD, D.G., WYATT, N.P.G., Radiometric Sorting of Ore, R.T.Z. Ore Sorters Ltd, South Africa (1982).
- [4.37] WANG, SHUHUI, Uranium Min. Metall. **1** 2 (1982) 69-72.
- [4.38] JANISCH, P.A., J. S. Afr. Inst. Min. Metall. **86** 8 (1986) 273-316.
- [4.39] SMITH, S.E., GARRETT, K.H., Some recent developments in the extraction of uranium from its ores, Chem. Eng. (London) **268** (1972) 440.
- [4.40] ADORJAN, L.A., Mineral Processing, Min. Annu. Rev. (1975) 225.
- [4.41] Mineral Processing, Min. Annu. Rev. (1976) 219.
- [4.42] GRIMES, M.E., Rio Algom investigations into preconcentration of uranium ore, Trans. Soc. Min. Eng. AIME **254** (1973) 312.
- [4.43] BURKIN, A.R., 'The Chemistry of Hydrometallurgical Processes', E.&F.N. Spon Limited (1966) p.7.
- [4.44] NUCLEAR ENERGY AGENCY OF THE OECD, INTERNATIONAL ATOMIC ENERGY AGENCY, Uranium Extraction Technology Current Practice and New Development in Ore Processing, OECD/NEA, Paris (1983).
- [4.45] CORRANS, I.J., "Comminution and preconcentration as applied to uranium-bearing ores", paper presented at Vacation School: Uranium Ore Processing, National Institute for Metallurgy, Johannesburg, 1981.
- [4.46] LIEBENBERG, W.R., The occurrence and origin of gold and radioactive minerals in the Witwatersrand System, the Dominion Reef, the Ventersdorp Contact Reef and the Black Reef, Trans. Proc. Geol. Soc. S. Afr. **58** (1955) 101-254.
- [4.47] WHITESIDE, H.C.M., Heavy Mineral Analysis of Two Reefs from the Far East Rand, M.Sc. Thesis, University of Witwatersrand (1943).
- [4.48] LEVIN, J., Concentration tests on the gold-uranium ores of the Witwatersrand for the recovery of uranium, J. S. Afr. Inst. Min. Metall. **57** 4 (1956) 209-254.
- [4.49] GUEST, R.N., The recovery of pyrite from Witwatersrand gold ores, J. S. Afr. Inst. Min. Metall. **76** (1975) 103-105.

- [4.50] GUEST, R.N., A Survey of the Literature on Gravity Separation, Report No. 2082, National Institute for Metallurgy, Johannesburg (1981) 16.
- [4.51] VAN DER SPUY, R.C.M., J. S. Afr. Inst. Min. Metall. **82** 2 (1982) 17-29.
- [4.52] TERRIL, I.J., VILLA, J.B., Elements of high-capacity, gravity separation, CIM Bull. **68** 757 (1975) 94-101.
- [4.53] FOURNIER, P., "Milling high grade uranium ore at Cliff Lake, Saskatchewan", paper presented at Canadian Uranium Producers Metallurgical Committee Bancroft, 1982.
- [4.54] TUTT, D.J., "Review of the application of beneficiation processes to uranium ores before leaching", The Recovery of Uranium (Proc. Symp. Sao Paulo, 1970), IAEA, Vienna (1970) 33-41.
- [4.55] DORR, J.V.N., BOSGIM, F.L., paper presented at Symp. on Recent Developments in Mineral Dressing, IMM, London, 1952.
- [4.56] GOLDNEY, L.H., CANNING, R.G., GODDEN, J.E.A. "Extraction investigations with some Australian uranium ores", Uranium Processing (Proc. AAEC Symp. Lucas Heights, 1972), Vol. 1, AAEC, Lucas Heights (1972) 18.
- [4.57] GOW, W.A., Concentration of Low Grade Aca Ores by Heavy Media Separation, Radioactivity Division, Rep. SR-136/52, Mines Branch, Department of Energy Mines and Resources, Ottawa (1952).
- [4.58] HONEYWELL, W.R., KAIMAN, S., Review of the Sink-Float Preconcentration of Elliot Lake Uranium Ores, Rep. IR 69-99, Mines Branch, Department of Energy, Mines and Resources Ottawa (1968).
- [4.59] CORRANS, I.J., LEVIN, J., Wet high-intensity magnetic separation for the concentration of Witwatersrand gold-uranium ores and residues, J. S. Afr. Inst. Min. Metall. **79** (1979) 210-228.
- [4.60] BRONCKA, W.J., Magnetic Separation Mineral Processing Plant Design, 2nd edn, Society of Mining Engineers (AIMM and PE), New York (1980) 67-478.
- [4.61] RAICEVIC, D., RAICEVIC, M., Preconcentration of Uranium Ores yielding Environmentally Acceptable Tailings; Part III: Elliot Lake Ore — 0.1% U, Rep. MRP/MSL 80-16(IR), Canadian Centre for Mineral and Energy Technology (1980).
- [4.62] STEWART, J.R., Atomic Energy Australia **10** 2 (1967) 17.
- [4.63] LI, SUYUAN, Uranium Min. Metall. **6** 4 (1987) 7-15.
- [4.64] BELL, D.H., CIM Bull. **72** 804 (1979) 177-180.
- [4.65] JANISCH, P.A., J. S. Afr. Inst. Min. Metall. **86** 8 (1986) 273-316.
- [4.66] LLOYD, P.J.D., J. S. Afr. Inst. Min. Metall. **81** 2 (1981) 41-47.
- [4.67] FROTZGERALD, M.L., KELSALL D.F., "Pilot plant concentration of Mindola uranium ore", Extraction and Refining of the Rare Metals (Proc. Conf. London, 1957), Institution of Mining and Metallurgy, London (1957) 163-174.
- [4.68] CREW, R.J., Mining and Metallurgical Practices at Olympic Dam, South Australia (Proc. Conf. Bergamo, 1989), German Association of International Mining (1989).
- [4.69] HARRINGTON, C.D., RUEHLE, A.E., Uranium Production Technology, Van Nostrand Reinhold, Princeton, NJ (1959) 43-68.
- [4.70] FULMER, J.M., The Oxides of Uranium, Rep. CF-51-10-133, USAEC, Oak Ridge Natl Lab., Oak Ridge, TN (1951) 30 pp.

- [4.71] KATZ, J.J., RABINOWITCH, E., *The Chemistry of Uranium*, McGraw-Hill, New York (1951) 244-322.
- [4.72] MERRITT, R.C., *Extractive Metallurgy of Uranium*, Rep. TID-25711, Colorado School of Mines Research Foundation, Golden, CO (1971) 576 pp.
- [4.73] HALPERN, J., et al., *Effect of roasting on recovery of uranium and vanadium from carnotite ores*, *Trans. Metall. Soc. AIME* **212** (1958) 65-70.
- [4.74] STATE OF COLORADO METAL MINING FUND BOARD, *Vanadium: A Composite Study*, Denver, CO (1961) 155 pp.
- [4.75] BUSCH, P.M., *Vanadium — A Materials Survey*, Rep. IC 8060, US Bureau of Mines, Washington, DC (1961) 95 pp.
- [4.76] RICHARDSON, C.A., et al., *The Recovery of Uranium from Carnotite Ores*, USAEC Rep. BMI-JDS-195, Battelle Memorial Institute, Argonne, IL (1949).
- [4.77] DRESHER, W.H., "A mechanism study of the formation of sodium vanadate compounds under the conditions of the salt roast process", paper presented at Annual AIME Meeting, St. Louis, MO, 1961.
- [4.78] DJINGHENZIAN, L.E., *Theory and practice of roasting sulfide concentrates*, *Trans. AIME* **55** (1952) 238-250.
- [4.79] WATSON, W. I., et al., *Chemical Behaviour of Uranium Minerals and Compounds*, USAEC Rep. RMO-2620, Arthur D. Little Inc., Washington, DC (1955).



## Chapter 5

### LEACHING

#### 5.1. INTRODUCTION

Leaching is an important step in the processing of a uranium ore. The leaching process controls the following:

- (a) The proportion of uranium solubilized from the ore;
- (b) The quantities of reagents, which are a major operating cost, required to maintain suitable leaching conditions;
- (c) The concentrations of impurities in solution, which will have an important impact on subsequent unit operations such as solvent extraction, product precipitation/purification and effluent treatment;
- (d) The grinding requirements, the performance of the solid-liquid separation equipment, the impact on disposal options and the characteristics of the waste tailing.

Uranium ores are treated by either acid or alkaline reagents with sulphuric acid or sodium carbonate-sodium bicarbonate systems used almost exclusively for commercial uranium recovery. In general, alkaline leaching is milder and more selective than acid leaching and is used for the treatment of high carbonate ores, which would consume excessive amounts of acid. A general guide has been that if the ore contains more than 7-9% of carbonates then alkaline leaching is more economical, but other factors must now be considered. Such factors include the efficiency of uranium extraction, water usage (particularly in remote locations), energy consumption, product quality requirements and environmental considerations [5.1].

Although acid leaching is used in the majority of uranium mills, alkaline leaching has a number of fundamental advantages; these are [5.2]:

- (a) The solution is more specific for uranium minerals, leaving most of the gangue unattacked.
- (b) Uranium can be directly precipitated from the leach liquor.
- (c) The carbonate solution can be easily regenerated.

These characteristics also lead to a number of disadvantages that include the following:

- (d) Fine grinding is required to expose the uranium minerals.
- (e) Some gangue minerals (such as calcium sulphate and pyrite) can react with the alkaline reagent resulting in a high consumption.
- (f) The more refractory uranium minerals are not dissolved under alkaline conditions.

The chemistry of acid and alkaline leaching is discussed further in Section 5.2.

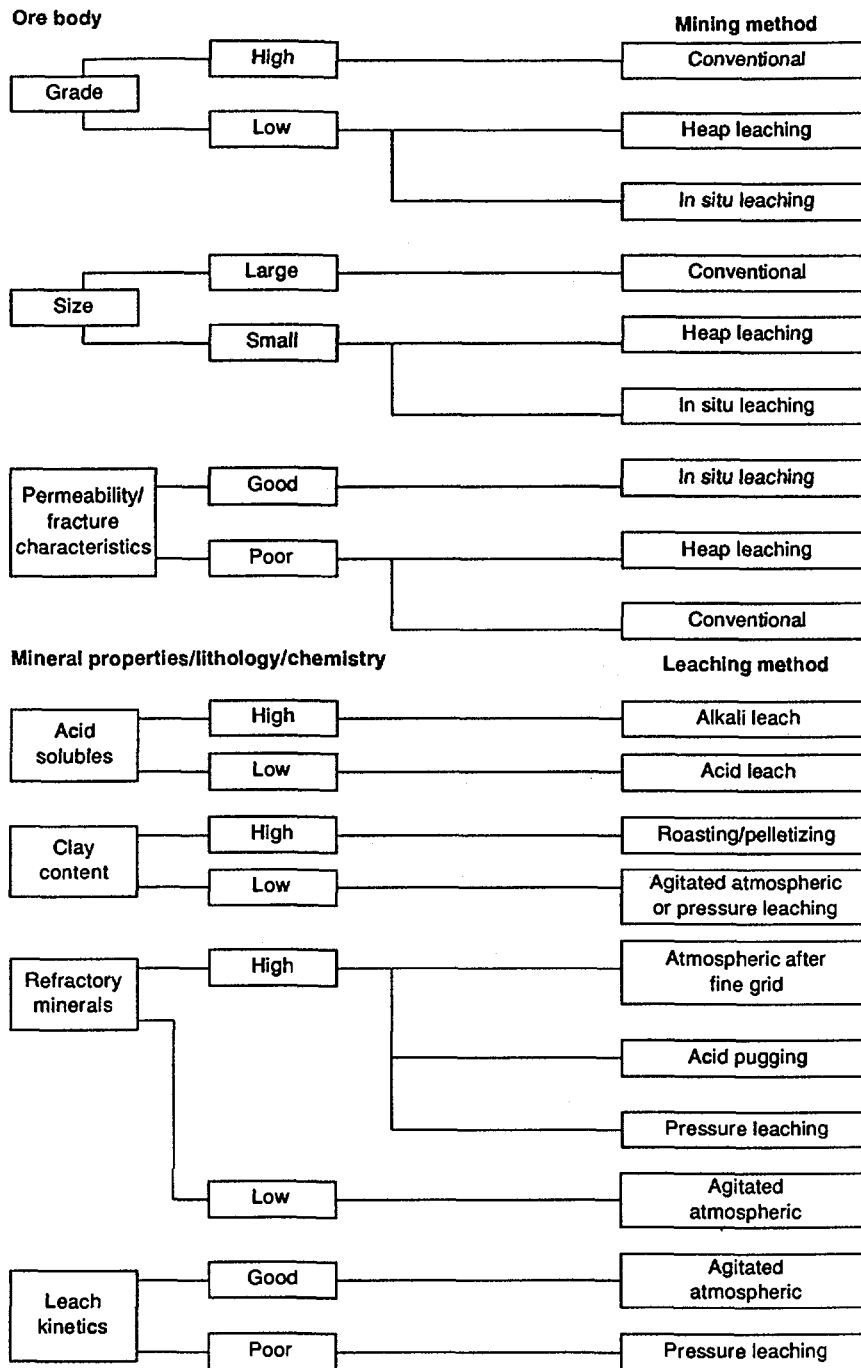

FIG. 5.1. Selection of leaching process.

After selection of the reagent the next major decision is the choice of the leaching system. The following five techniques are available:

- (1) Agitation leaching at atmospheric pressure (acid and alkaline),
- (2) Pressure leaching (acid and alkaline),
- (3) Strong acid pugging and curing (acid),
- (4) Heap leaching (acid),
- (5) In situ leaching (mainly alkaline).

The factors affecting the choice of leaching system are summarized in Fig. 5.1.

The ore grade and tonnage will usually determine the selection of processes (4) and (5) rather than (1), (2) and (3). Briefly, both solution mining and heap leaching are largely restricted in application to ores with mineralogical characteristics and textural features that permit the access of reagents to the uranium mineral over a sufficiently long period. Modified processes such as thin layer leaching, with a greater degree of comminution, may extend the range of ore types that can be processed in a heap leach fashion.

In situ leaching is at present limited in application to confined sandstone formations (high permeability) containing comparatively small deposits of low grade ore at a relatively shallow depth. However, it can offer significant economic advantages as the well field replaces the mining and crushing operations and leaching equipment associated with conventional processing. Its disadvantages are the low recovery and the stringent requirements to restore the mined area to acceptable conditions [5.3].

Heap leaching also suffers from poor recovery, without offering the cost savings associated with in situ leaching. The ore must be mined, transported and sometimes crushed before being leached. The preparation of an impervious base is usually required. Improvements in extraction efficiency require innovations such as pelletizing and the provision of leach vats [5.4]. Finally, the dump must be removed, or otherwise processed to meet environmental requirements.

Where low grade ore is involved, the more modest capital and operating requirements of a heap leaching operation give it an economic advantage over conventional leaching routes, in particular where bacterial action and in situ sulphide minerals can be used to provide a degree of autolixiviation [5.4]. Heap leaching is obviously attractive for processing below ore grade uranium material (bogum) stockpiled during mining operations. However, bogum is often weathered and too fine for a heap leaching operation without pelletizing or treatment to remove fines.

The choice between the leaching systems (1), (2) and (3) is mainly determined by the mineralogy of the uranium and the gangue. Agitation leaching at atmospheric pressure is most commonly used, with pressure leaching employed for refractory uranium minerals and alkaline conditions where the rate of reaction is too slow under conventional conditions.



Strong acid pugging is generally used for treating refractory ores. Reaction times and acid consumption in this type of process are generally less than in conventional acid leaching and higher extractions from quite refractory ores can be obtained using an ore that is much coarser than is required with conventional processes. The ability to use a coarser ore not only reduces the grinding costs but also makes subsequent separation of the pregnant leach solution from the leach residue easier [5.5]. This technique is also advantageous for ores where normal agitation leaching results in the rapid breakdown and dispersion of clays and the dissolution of large quantities of silica [5.6].

Leaching with hydrochloric acid, as an alternative to sulphuric acid, has been under investigation to dissolve radium (and other metallics) so that it does not report to the tailings as a perpetual source of radioactivity. Chloride leaching is not cost competitive with sulphuric acid if uranium processing is the only concern, but could be adopted to satisfy environmental regulations. Detailed descriptions of the above techniques are presented in later sections.

## 5.2. LEACHING CHEMISTRY

The chemistry of uranium dissolution has been concisely summarized in Refs [5.7, 5.8]. Uranium minerals can be dissolved by acid or alkaline (carbonate) solutions. There are two valency states in which uranium occurs naturally — the hexavalent form, the oxide of which is  $UO_3$ , and the tetravalent form, the oxide of which is  $UO_2$ . In its hexavalent form uranium goes directly into solution as given by Eq. (5.1).



In the case of hexavalent salt type mineral compounds, a simple double decomposition applies by thermodynamic solubility equilibria criteria. In solution the uranyl ion forms stable complexes (uncharged or an anion) with the sulphate ion and in the case of alkaline solutions with the carbonate ion, thus:



For reaction (5.1), as applied to the alkaline carbonate process, the hydrogen ion is supplied by bicarbonate which must be present for this purpose. When the uranium is present in the tetravalent form as in  $UO_2$ , which it is in part in uraninite, it does not dissolve at a perceptible rate and requires oxidizing to the hexavalent form; thus:



The oxidation reaction can be quite complex, rapid oxidation in an acidic medium being achieved mainly by the presence of ferric ions in solution:



Hydrogen ions are not involved in this reaction. However, to maintain the dissolution of the  $\text{UO}_2$ , the  $\text{Fe}^{3+}$  must be renewed by subsequent oxidation of the  $\text{Fe}^{2+}$  formed in Eq. (5.5), a reaction that requires hydrogen ions. Thus, if manganese dioxide is used as the source oxidant, the following reaction takes place:

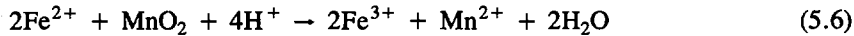

The consumption of acid required to achieve the equivalent oxidation of ferrous ion is reduced by 50% if sodium chlorate or Caro's acid are used instead of pyrolusite [5.9]:

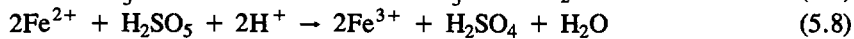
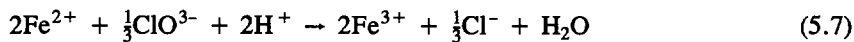

The role of the ferric ion in the acidic dissolution of  $\text{UO}_2$  is most important. It reacts as an electron transfer agent [5.10, 5.11]. Neither oxygen, manganese dioxide nor chlorate ions, for example, are effective in oxidizing  $\text{UO}_2$  at practical rates under ambient conditions of temperature and pressure.

A  $\text{Fe}^{3+}$  concentration of about 1 to 2 g/L is usually considered adequate for the effective dissolution of uraninite [5.10]. The dissolution rate is also affected by the presence of  $\text{Fe}^{2+}$  ions, but the form of the dependence is determined by the  $\text{Fe}^{3+}/\text{Fe}^{2+}$  ratio. The ferric iron concentration in leach liquor is controlled by adjusting the redox potential by the addition of oxidant. For typical leaching conditions the relationship between the redox potential and the iron concentrations is given by the Nernst equation [5.12]:

$$E_c = 397 + 0.1984T \log ([\text{Fe}^{3+}]/[\text{Fe}^{2+}]) \quad (5.9)$$

where  $E_c$  is the solution potential relative to the saturated calomel electrode at 35°C (mV), [ ] is the molar concentration and  $T$  is the temperature (K).

Equation (5.9) shows that at an oxidation potential of 400 mV about 50% of the iron is in the ferric state, while at 500 mV only 2% remains as ferrous ion.

A model for the prediction of the leach pulp redox potential has also been developed using plant data from the Hartebeestfontein operation [5.13]. Typical leach conditions were a temperature of 70°C, an acid concentration of 4 to 7 g/L and a total iron concentration of 4 to 8 g/L. The standard error using Eq. (5.10) was

5.7 mV in the data range of 350 to 500 mV:

$$E_c = 399.8 + 0.14T \log A + 0.21T \log ([Fe^{3+}]/[Fe^{2+}]) \quad (5.10)$$

where  $A$  is the sulphuric acid concentration (g/L).

The redox potential required to achieve complete oxidation is essentially unaffected by the ore type (i.e. vein or sandstone) and gangue mineralogy. A satisfactory level of uranium extraction is obtained for most ores by maintaining an oxidation potential of 450 mV with respect to a saturated calomel electrode at a temperature of 35 to 40°C. If the concentration of iron in solution is greater than 5 to 7 g/L after 1 h of leaching, a potential of 400 mV is adequate [5.14]. Leaching at potentials greater than 450 mV often increases the initial rate of extraction but the overall rate and ultimate recovery are not improved. Unnecessarily high potentials must also be avoided to minimize the acid consumed by the oxidation of ferrous ion and problems in solvent extraction from solvent degradation products [5.15].

Ferric ions cannot be maintained in alkaline carbonate solutions and it is the lack of such a catalyst that is largely responsible for the very different conditions required in carbonate leaching as compared with acid leaching. Carbonate leaching calls for more severe conditions of pressure and temperature, often a longer leaching time, and a finer grind. The rate of leaching is controlled by the oxidation of  $U^{4+}$  [5.8]. For the reaction with oxygen an electrochemical mechanism has been proposed [5.16]. The reactions involved in the alkali leaching process can be represented as

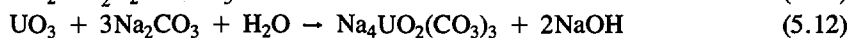

In order to prevent the pH rising to a value at which reprecipitation of uranium will occur, sodium bicarbonate is used to buffer the hydroxide formed. The overall reaction is

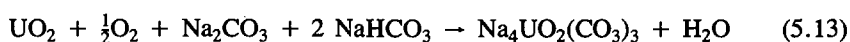

### 5.3. LEACHING CONDITIONS AND MINERALOGY

The mineralogy of uranium minerals and gangue are the most important factors controlling the process conditions required to achieve a satisfactory level of uranium dissolution with an acceptable consumption of reagent. Fortunately, many uranium minerals are relatively easy to leach under those conditions in which most of the associated gangue minerals are relatively unreactive.

TABLE 5.1. COMMON URANIUM MINERALS

Type	Name	Composition
Oxides	Uraninite	$(U_{1-x}^{4+} U_x^{6+})O_{2+x}$
	Pitchblende	Variety of uraninite
Hydrated oxides	Becquerelite	$7UO_2 \cdot 11H_2O$
	Gummite	Alteration product of uraninite <sup>a</sup>
Nb-Ta-Ti	Brannerite	$(U, Ca, Fe, Th, Y)(Ti, Fe)_2O_6$
Complex oxides	Davidite	Ideally $FeTi_3O_7$
Silicates	Coffinite	$U(SiO_4)_{1-x}(OH)_{4x}$
	Uranophane	$Ca(UO_2)_2(SiO_3)_2(OH)_2 \cdot 5H_2O$
	Sklodowskite	$(H_3O)_2Mg(UO_2)_2(SiO_4)_2 \cdot 2H_2O$
Phosphates	Autunite	$Ca(UO_2)_2(PO_4)_2 \cdot 10-12 H_2O$
	Torbernite	$Cu(UO_2)_2(PO_4)_2 \cdot 12H_2O$
	Saleeite	$Mg(UO_2)_2(PO_4)_2 \cdot 10H_2O$
Vanadates	Carnotite	$K_2(UO_2)_2(VO_4)_2 \cdot 1-3 H_2O$
	Tyuyamunite	$Ca(UO_2)_2(VO_4)_2 \cdot 5-8 H_2O$
Arsenates	Zeunerite	$Cu(UO_2)_2(AsO_4)_2 \cdot 10-12 H_2O$
Carbonates	Schroëckingerite	$NaCa_3(UO_2)(CO_3)_3(SO_4)F \cdot 10H_2O$
Hydrocarbons	Thucholite	Uraninite complex with hydrocarbons
	Asphaltite <sup>b</sup>	Many varieties containing U-organic complexes

<sup>a</sup> Gummite is a generic name for uraninite alteration products and may include silicates, phosphates and oxides.

<sup>b</sup> Actually a variety of thucholite but the term may be used in a broad sense to describe a number of solid uraniferous bituminous hydrocarbons.

### 5.3.1. Uranium

#### 5.3.1.1. Mineralogy

An understanding of the mineralization concepts of uranium leads to a better understanding of the expected leaching behaviour [5.17]. In nature, uranium exists mainly in the valence states  $U^{4+}$  (tetravalent) and  $U^{6+}$  (hexavalent). The mineralogy and geochemistry of the valence states are dissimilar. Tetravalent uranium is readily oxidized and is stable only under reducing conditions. Hexavalent uranium forms a complex uranyl ion  $(UO_2)^{2+}$  that combines with other elements in oxides, silicates, sulphates, vanadates, arsenates, carbonates, phosphates and molybdates.

Uranium minerals may be termed primary or secondary, depending upon their degree of oxidation and origin. The common uranium minerals are listed in Table 5.1. The most important primary ore minerals are uraninite, an oxide, and coffinite, a silicate. Pitchblende, also a primary mineral, is a colloform variety of uraninite. Through progressive oxidation, the secondary minerals may be formed from elements and ions derived from the primary minerals, from the intrinsic host constituents, or from migrating groundwaters, under varying pH conditions. The transformation from primary to secondary minerals is gradual and complex. Oxidation is progressive and influenced by migrating groundwaters, weathering by exposure to the atmosphere, and topographic and climatic conditions.

Uraninite has the ideal chemical composition  $\text{UO}_2$ , but material of this composition does not exist in nature as it is always partly oxidized with conversion of  $\text{U}^{4+}$  to  $\text{U}^{6+}$ . The degree of oxidation ranges from 17 to 60% [5.18]. The primary ores occur in water saturated rocks below the water table and the zone of oxidation. Primary minerals other than uraninite and coffinite are a group containing niobium, tantalum and titanium, which are known as multiple oxides of uranium. The group includes the uranium minerals, davidite and brannerite.

When oxidized, the uranium associated with vanadiferous uranium ores is readily soluble, but the vanadium content is relatively refractory. Typical examples are carnotite, tyuyamunite and metatyuyamunite, which are all yellow uranium hydrated vanadates. The secondary minerals are often found as crusts, powdery aggregates, and platy, acicular, fan-like coatings and films, in contrast to the heavy and massive primary minerals.

Hydrated uranium oxides are not abundant because sulphates, carbonates or other anions are usually present to combine with the  $(\text{UO}_2)^{2+}$  ion. Small quantities of becquerelite and gummite (the generic name for the alteration products) are closely associated with oxidized uraninite. They develop next to the cores of unoxidized uraninite and are removed from the outside of the rim until the source has disappeared.

Some uranium minerals are formed by the evaporation of uranium bearing groundwaters. These calcrete deposits may also be termed primary in that they formed first rather than being oxidation products.

The most common and widespread secondary minerals are carnotite, tyuyamunite, metatyuyamunite, saleeite, sklodowskite, torbernite, metatorbernite, autunite, metaautunite, uranophane, schroëckingerite and zeunerite. Minerals prefixed by meta are chemically and physically the same but have a lower water content. The limits of the fully hydrated minerals are between 10 and 12  $\text{H}_2\text{O}$  and 4 to 8  $\text{H}_2\text{O}$  for the metahydrates.

Copper is associated with uranium at many deposits and in the oxidized zone, torbernite and metatorbernite may be found. Both are hydrous copper-uranium phosphates. In the same phosphate groups are autunite and metaautunite, which are calcium uranyl hydrated phosphates. Both frequently occur with torbernite, and are

similar except that calcium substitutes for copper. Uranophane is also similar to torbernite and autunite, except that a silicate is contained in place of a phosphate. In general, it is found when calcium and silicate predominate. Similarly, autunite and torbernite are found when calcium phosphate and copper phosphate predominate, respectively. Since autunite and uranophane contain calcium, they are relatively insoluble, and may form as caliche deposits or oxidation products.

### 5.3.1.2. Leaching behaviour

The behaviour of uranium minerals in processing can be described under the following two classifications suggested in Ref. [5.19]:

- (1) Ores in which the main uranium containing minerals are taken into solution with sufficient ease so that the uranium can be extracted economically, although the details of the treatment are determined as much by gangue mineralogy and chemistry as by the uranium mineralogy. (The uranium can be extracted by acid and alkaline conditions.)
  - (a) Ores containing uraninite or pitchblende and coffinite with much of the uranium in the quadrivalent state and hence requiring an oxidant;
  - (b) Ores containing secondary minerals such as gummite, becquerelite, autunite, saleeite, sklodowskite, torbernite, uranophane, carnotite, etc., with uranium in the hexavalent state and hence requiring no oxidant.
- (2) Ores in which the uranium mineral requires such severe conditions for dissolution that the mineralogy and chemistry of the gangue usually determines whether the ore can be processed at all. These are ores containing a predominance of the 'multiple oxide' type of uranium minerals (niobates, tantalates, titanates, zircon, etc.). The most important economic mineral in this class is brannerite. (These minerals cannot be recovered by alkaline leaching.)

In normal acid leaching, under the correct oxidizing conditions, the principal requirement is to maintain a free acid concentration sufficient to attack the uranium minerals without dissolving an excessive quantity of gangue minerals. At the end of leaching sufficient free acid must remain to prevent the precipitation of uranium in the washing circuit.

Type (1)(a) minerals are readily dissolved in sulphuric acid with a pH of 1.8–2.0 at 40°C in 12 hours or less, provided that the uranium minerals are exposed or the gangue is sufficiently permeable to allow access of the lixiviant. A longer leach time may be required to allow access to uranium minerals in gangue fragments with lower permeability. A lower value of the pH may also facilitate the attack of other non-uranium minerals and so gain access to the uranium inside individual particles.

Recent leaching studies have shown that the dissolution of coffinite is slower than uraninite mineralization [5.20]. Where the rate of extraction is controlled by the slower dissolution of partially exposed coffinite (or uraninite), the kinetics can be improved by leaching at a high redox potential (500 mV). The rate of dissolution of coffinite has also been found to be influenced by the U/Si ratio in the mineral. Coffinite has the capacity for a wide range of hydroxyl substitution of the silicate component. Examination of leach residues from a number of Australian ores has shown that the solubility was enhanced with increasing substitution of  $\text{SiO}_4$  ions by  $\text{OH}^-$ . It also appeared that after partial leaching of uranium from coffinite with a low U/Si ratio, the remaining silicate enriched residue recrystallized into a less soluble form of secondary 'coffinite' that resisted further leaching.

Canadian studies of the leaching of individual ore grains have also shown that [5.21]:

- (i) Regardless of the leaching conditions uranothorite dissolved more readily than uraninite.
- (ii) The overall leaching kinetics of uraninite were enhanced by the presence of a uranothorite alteration product, such that the overall leaching rate increased with the extent of alteration.
- (iii) Uraninite dissolution was initiated at the walls of channels (formed by the dissolution of uranothorite from fractures) and progressed radially through the grain.
- (iv) Dissolution of uranothorite was initiated and progressed over its entire exposed surface. Dissolution kinetics were not influenced by its mode of occurrence (i.e. whether as a primary grain, as inclusion in monazite, or the alteration product of uraninite).
- (v) U rich uranothorite showed a more rapid dissolution kinetics than Th rich uranothorite.

The same work showed that monazite was only soluble in  $\text{H}_2\text{SO}_4$  solutions at temperatures higher than  $85^\circ\text{C}$ . After leaching for 8 h monazite did not dissolve in 75 g/L  $\text{H}_2\text{SO}_4$  at  $60^\circ\text{C}$ .

Type (1)(b) minerals generally respond to conditions suitable for (1)(a) minerals. However, it has been suggested that equilibrium solubility considerations indicate that minerals containing phosphates and vanadates may require higher acidities in the leaching solution [5.7]. If torbernite and autunite are major contributors of uranium in an ore, pH values of between 1.0 and 1.5 are more effective in increasing the leaching rate.

Phosphate ions can also complex ferric ions and interfere with the usual role of the ferric ion as an electron transfer carrier in the oxidation of tetravalent uranium. In addition, phosphate can lead to reprecipitation of uranium unless a relatively low value of pH is maintained. Laboratory work has shown that the latter effects may, in fact, account for the apparently slower dissolution of uranium phosphate minerals

at high pH values. The presence of phosphate ion in solution has also been shown to suppress the dissolution ratio of certain uranium phosphate minerals [5.10].

The dissolution of Type (2) minerals requires more severe conditions than those for Type (1). The most important mineral (in terms of occurrence) in this class is brannerite. Dissolution is favoured by high acid concentrations and temperatures; the extraction rate is reported to increase fourfold for a change in temperature from 50 to 70°C [5.22]. Dissolution was also directly proportional to the free acid concentration in the range from 20 to 100 g/L. However, the acid leaching medium must not be too strong; very high proton concentrations inhibited the oxidation of  $U^{4+}$  to  $U^{6+}$ . At concentrations higher than 200 g/L the leaching response was inhibited.

Studies of South African ores have also shown that brannerite only starts to react at 60°C [5.23]. The use of acid concentrations greater than 10 g/L and leaching times longer than 10 h improved the rate of dissolution, which was much slower than that of uraninite. The formation of residual titanium oxide at the surface of the grains further delayed the reaction of the underlying brannerite. The behaviour of Witwatersrand uranous titanates, which have a  $UO_2$  to  $TiO_2$  ratio above one, was similar to that of brannerite, but the removal of uranium from uraniferous leucoxene species with  $UO_2$  to  $TiO_2$  ratios below one was faster and started at 40°C. The extraction of uranium from these latter species would be complete under typical leaching conditions.

Some uraniferous zircons will dissolve under the conditions suitable for brannerite extraction, but others are most refractory. This difference in behaviour is probably due to atomic disorder (metamictization) caused by internal irradiation.

Only type (1) minerals are dissolved under alkaline conditions. Scanning electron microscope examination of ore leached under mild alkaline carbonate conditions (0.5 g/L  $NaHCO_3$ , oxygen pressure of 690 kPa, 32°C for 7 months) to simulate in situ processing showed that uraninite on the surfaces of sand grains was readily leached [5.24]. Uraninite that filled pores and cracks of the sand grains was also dissolved. Uranium vanadate, which also originally coated grain surfaces, remained insoluble.

### 5.3.2. Gangue minerals

As most uranium minerals are readily leached the economics of extraction will depend significantly on the relative dissolution rates of the accompanying gangue minerals. Gangue dissolution also determines the composition of leach liquor and its effect on subsequent operations.

The nature of the gangue minerals and their interaction with uranium minerals is, to some extent, determined by the geological setting of the deposit. Uranium deposits have been classified into a number of categories, with the most important being conglomerate, sandstone and vein type deposits. Uranium occurs as veins of uranium rich minerals, in fractures in igneous rocks, between the pebbles of



conglomerate ores and as impregnations and pore fillings in the host rock in sandstones. The significance of deposit type is discussed in detail in Ref. [5.22].

### 5.3.2.1. Leaching behaviour

The following summary of the gangue mineral reactivities is partly taken from Ref. [5.7].

*Quartz:* Quartz is a non-reactive mineral and the fact that it is the major component in some of the world's largest uranium deposits contributes (by default of other reactive minerals) to the economic exploitability of these ores.

*Carbonates:* Most carbonate minerals consume their stoichiometric equivalent of acid at the pH value required for the dissolution of uranium minerals. However, magnesite is quite unreactive at a pH value of 1.2 [5.20], and some dolomites and siderites react relatively slowly. For example, exposed dolomite required 0.5 to 1 h at a pH value of 1.8 (40°C) for complete removal [5.20]. A slow reaction is an advantage as foaming caused by the evolution of CO<sub>2</sub> from the vigorous reaction of calcite can be a processing problem. (Gypsum by contrast is a problem in alkaline leaching, reacting to form calcium carbonate and sodium sulphate.)

*Phosphates:* Apatite is not as reactive in acid as carbonate and its reactivity is variable. However, to a greater or lesser degree, it consumes acid at relatively low acidities and its rate of dissolution at pH values of 1.5 or less is significant. In addition, phosphate in solution can complex the ferric ions and thus inhibit their role in the oxidation process. In subsequent processing stages, phosphate can lead to reprecipitation of uranium unless the pH value is maintained below 2.0.

*Silicates:* The silicates have been classified according to their following three reactions with acids [5.25]:

- (a) Those that are not readily decomposed by acids, that is
  - (i) those that contain highly polarizing cations such as zirconium (zircon) and beryllium;
  - (ii) those silicates, such as kaolinite, in which the metal cations are not readily accessible to the acid;
- (b) Those from which the cations but not the silica can be readily dissolved, for example chrysocolla;
- (c) Those from which the cations and silica readily dissolve, that is
  - (i) the more simple silicates containing poorly polarizing cations such as zinc (willemite),
  - (ii) the silicates containing substantial quantities of aluminium and/or ferric iron in the silicate networks.

The silicate minerals occurring in most of the world's large uranium deposits are those associated with weathered material in sedimentary rocks, in metasediments and their weathering products. These secondary silicates, such as chlorite, sericite and various clay minerals, dissolve partly in dilute acid and contribute most of the aluminium, magnesium, iron and silica in leach liquor [5.19]. Examination of Witwatersrand ores has shown that dissolution of a brucite-like layer (incorporated into the double layered structure) accounts for about 34% of the chlorite dissolved by acid attack [5.26].

In the absence of highly reactive minerals, the secondary silicates effectively control the leaching process and subsequent operations, as all react in acid below a pH value of 2.0, and can be particularly reactive below a pH value of 1.5. The leaching temperature is also very important, with reaction rates increasing significantly above 40°C.

The tendency of the silicate minerals to form slimes can often assume more importance than their consumption of acid [5.19]. Slimes are comprised of leaching debris, colloidal silica and aggregates of 'precipitated silica'. These aggregates can be up to 0.3  $\mu\text{m}$  in diameter, but they mainly consist of smaller (0.1  $\mu\text{m}$ ) diameter particles [5.20]. These slimes affect the performance of the solid-liquid separation stage and, ultimately, the solvent extraction. Silica based particles of this size are active at the solvent-aqueous interface and can stabilize aqueous continuous emulsions. The rate of polymerization and aggregation of silica to form the size range that stabilizes organic droplets is dependent on the pH value, the temperature (to an even greater extent) and the composition of the solution.

The presence of fluoride ions catalyses the polymerization of silica, with the formation of colloids, and eventually precipitation, a process that is significantly accelerated below a pH value of 1.8 and at temperatures greater than about 45°C [5.4].

Precipitated silica particles (of size 0.45–3  $\mu\text{m}$ ) are difficult to remove by conventional clarification processes and can contribute significantly to the suspended solids level in the pregnant liquor feed to the solvent extraction. Solids of this nature also stabilize aqueous continuous emulsions [5.27], leading to crud formation in the settler. More seriously, the presence of these solids at the aqueous-organic interface will destabilize the phase continuity in mixing [5.28].

Polyox coagulant (a high molecular weight polymer of polyethylene oxide that forms hydrogen bonds with polymeric and colloidal silica) has been used to remove silica from pregnant liquors in the Key Lake and Rabbit Lake mills, and is proposed for treating liquors from the Midwest Lake ore [5.29–5.31]. This reagent is relatively expensive and can be difficult to make up to the required specification under plant conditions. After 12 months use at Rabbit Lake the addition of polyox was stopped, as it had proved to be ineffective [5.30].

*Iron oxides:* Hematite and magnetite are quite unreactive above a pH value of 1.0 [5.20], but the rate of dissolution of the hydrous oxides–hydroxides (such as goethite) is usually significant over the pH range used in uranium leaching.

*Sulphides:* The behaviour of sulphides such as the silicates cannot be explicitly predicted. In general, pyrites and chalcopyrites are not attacked under mild acidic leaching conditions (pH, 1.5; temperature, 40°C; duration, 18 h), but chalcocite is readily dissolved. Bornite dissolves slowly, but steadily, under these conditions with the rate of dissolution enhanced at lower pH values and high temperatures and by the presence of ferric ions [5.20, 5.32]. Sulphides are a major consumer of reagents in carbonate leaching [5.32].

The dissolution of sulphides in 10 g/L acid at 40°C has also been reported to decrease in the following order: gersdorffite, pyrrhotite, cobaltite, arsenopyrite, marcasite and chalcopyrite. Spalerite did not appear to react under the same conditions [5.23].

Sulphides can be removed by flotation, with conventional sulphuric acid production from the concentrate [5.33]. The case for sulphide flotation is strengthened by the possibility of eliminating or at least minimizing the residual sulphide going to the tailing, which leads to acid generation through bacterial action [5.34].

*Fluorite:* Fluorite dissolves readily over the range of conditions used in uranium leaching, with the rate of leaching increasing as the acidity and temperature are increased. In general terms, 50% dissolution could be expected at a pH value of 1.5, a temperature of 40°C and a time of 18 h [5.20]. The dissolution of fluorite is complicated by the precipitation of insoluble fluorides (such as rare earths). Apart from the increased acid consumption, the presence of fluoride ions in solution can:

- lead to the formation of colloidal silica (see above),
- accelerate the dissolution of other gangue minerals (this effect is not usually significant as the fluoride ion forms strong complexes with aluminium ions),
- enhance the dissolution of uranium minerals [5.26, 5.35].

*Calcium sulphate:* Calcium sulphate minerals and other sulphates react readily with sodium carbonate in alkaline leaching [5.2, 5.23].

*Carbonaceous constituents:* Graphite and related materials present in carbonaceous shales are generally unreactive but can lead to problems owing to the physical locking of the disseminated uranium mineral, or sometimes in the solids–liquid separation processes. An increased consumption of oxidant can also occur. For uraninite disseminated in kerogen or thucolite, high uranium levels in the residues have been attributed to the non-wetting of carbon particles, which tend to float and thus avoid the full rigours of milling and chemical attack in air agitated Pachucas [5.36].

*Rare earth minerals:* The rare earth minerals monazite, xenotime, bastnaesite and florencite are all quite insoluble above a pH value of 1.0 at 55°C [5.20]. However, synchisite (a fluorocarbonate containing calcium) and churchite (an yttrium phosphate) will dissolve under mild (pH value of 1.5) leaching conditions. Yttrium and the heavy rare earths are often incorporated into coffinite and, to a lesser extent, uraninite and brannerite. It is the dissolution of these minerals that contributes to the rare earth content of uranium leach liquors [5.20].

## 5.4. SULPHURIC ACID LEACHING SYSTEMS

### 5.4.1. Atmospheric agitation

All commercial uranium mills that employ acid leaching use sulphuric acid as the leaching agent because of its ready availability and low cost. (The one exception is the recovery of uranium by nitric acid leaching of a uranothorianite concentrate produced by gravity concentration at the Palabora mining operation [5.7].) Sulphuric acid is either transported to site, or manufactured on site from sulphur or SO<sub>2</sub> off-gas from the smelting of sulphide concentrates. Acid may also be generated autogenously by treating ore that has an appreciable sulphides content with air or oxygen under pressure before leaching. The parallel generation of ferric iron can also be an important bonus. Alternatively, sulphide flotation can be used to produce a concentrate. The case for sulphide flotation is strengthened considerably by the possibility of eliminating or at least minimizing the residual sulphide going to the tailings, which leads to the generation of acid through bacterial action [5.34].

Leaching is usually conducted in a number of tanks connected in series with ore slurry flowing from tank to tank via overflow launders. The pulp density is usually the maximum possible (typically 55 wt%) to minimize reagent consumption and circuit volume. However, the rheological properties of the ore in aqueous suspension may limit the density to a level where adequate mixing of reagents and control of leaching conditions can be obtained. High pulp densities will also increase the concentrations of troublesome liquor components, for example silica, and raise the temperature of the circuit, if the heat of dilution of sulphuric acid is significant. At Rossing, a pulp density as high as 72 to 73% is used to assist in maintaining the coarse particles in suspension (Chapter 5).

Any continuously fed cascade of mixed vessels will exhibit a degree of bypassing that reduces the effective residence time of the system. This can be avoided by the operation of a number of vessels in a batch wise fashion, and by sequential filling, holding and draining of each vessel. Such a system is used at the Chemwes plant in South Africa, where the leaching section consists of flat bottomed Pachucas. One Pachuca is fed continuously for reagent addition and the remainder in batch sequence [5.36].

TABLE 5.2. DETAILS OF RECENTLY CONSTRUCTED LEACHING CIRCUITS

Mill	pH	Temperature (°C)	Time (h)	Oxidant	Tank construction	Agitation
Olympic Dam	1.5	55	12	NaClO <sub>3</sub>	RL steel <sup>a</sup>	Mechanical
Ranger	1.9	40	20	Pyrolusite	RL steel	Pachuca
Nabarlek	1.5	40	24	Caro's acid	RL steel	Mechanical
Rabbit Lake <sup>b</sup>	25 <sup>g</sup>	55	10	NaClO <sub>3</sub>	Wood stave <sup>c</sup>	Mechanical
Cluff Lake <sup>d,e</sup>	0.5	55 <sup>f</sup>	3.5	NaClO <sub>3</sub>	RL steel	Mechanical
Cluff Lake <sup>c</sup>	1.2-1.4	50	7	NaClO <sub>3</sub>	Wood stave	Mechanical
Bear Creek	8 <sup>g</sup>	35	8	NaClO <sub>3</sub>	Wood stave	Mechanical
Jouac	15-25 <sup>g</sup>	65	9	NaClO <sub>3</sub>	Wood stave	Mechanical
Mounanna	12-15 <sup>g</sup>	55-60	7	Pyro/NaClO <sub>3</sub>	Wood stave	Mechanical
Rossing	3-7 <sup>g</sup>	50	10	Pyrolusite	RL steel	Mechanical

<sup>a</sup> Rubber lined steel.

<sup>b</sup> Second phase of operation.

<sup>c</sup> Lined with abrasion resistant polythene.

<sup>d</sup> High grade operation.

<sup>e</sup> First phase of operation.

<sup>f</sup> Cooled to maintain temperature.

<sup>g</sup> In units of g/L.

#### 5.4.1.1. Tank construction

Recent practice has been to use wood stave construction or rubber lined steel (Table 5.2). To avoid damage to the lining, the operating temperature must be maintained at less than 70°C. Tanks are often fitted with a cover to reduce the emission of fumes (and radon for high grade ores), which are extracted through a small vent pipe attached to the cover. Alternatively a half-cover roof is provided to protect the steelwork. The tanks are usually baffled and fitted with an outlet upcomer to minimize stratification and short circuiting of the slurry.

#### 5.4.1.2. Agitation

Both mechanical agitation and air agitation (Pachucas) have been installed in recently constructed mills. The choice of agitation method is dependent on a number of variables such as ore density, particle size, size distribution and the abrasive

nature (determined by the shape and mineralogy) of the feed slurry. Pachucas would be favoured for fine or abrasive slurries, but sanding out can easily occur unless the slurry conditions (pulp density) are maintained within the desired range. For coarse pulps the air consumption can be unacceptably high.

Mechanical agitation with rubber lined propeller or turbine agitators is probably the most widely used mixing technique. In recent years the adoption of large, high displacement, axial flow propellers has significantly reduced the power requirements for many operations. At Rossing, in Namibia, tanks containing 1450 m<sup>3</sup> of slurry are operated with 260 kW agitators [5.7]. Radioactive tracer tests have demonstrated that, with this system, at least 87% of the tank contents are actively mixed. This is a significant improvement over the originally installed agitators, which were curved, marine type, propellers operated at 120 kW. This arrangement was totally inadequate and resulted in the formation of massive sandbanks in the tanks (Chapter 15). Despite these advances, problems have still been encountered with small leach tanks. At the Nabarlek mill, additional impellers were added to all the leach tanks (55 m<sup>3</sup> capacity) to improve the mixing in the 2 m zone just below the surface [5.37]. Prior to this modification, poor control of free acid and oxidation reduction potential (ORP) levels was frequently obtained because of the poor mixing of reagents added near the surface. Although there has been a gradual acceptance of ever larger mechanically agitated tanks, some plants have shown a preference (depending on the economics) for Pachucas because of uncertainties in the mechanical design of very large leaching vessels [5.36].

Conical bottomed Pachuca leaching units have been used successfully in acid leaching operations, for example in Australia, Canada and South Africa. The mixing action in a Pachuca is relatively gentle, and if a scrubbing action is desirable during leaching, mechanical agitation may be preferable. A mild degree of scrubbing or attritioning can increase the leaching rate for sandstone type ores. In South Africa a number of recent mills have reflected the fact that flat bottomed Pachucas are cheaper to construct than conical bottomed vessels of the same capacity and can be designed so that sanding out and dead areas are minimized [5.36].

The supply of compressed air is a major cost in the operation of Pachucas. An alternative design, which uses downflow draft tube agitators in tall flat bottomed tanks, offers potential cost benefits. Although the first uranium leaching plant to install this equipment suffered mechanical and structural failures, this principle has been successfully applied using carbon in pulp contactors. The proper design and construction of the draft tubes appears to be very important to prevent failure [5.36, 5.38].

#### *5.4.1.3. Circuit operation and reagent addition*

Leaching circuits have contained up to twelve tanks in series, but four to five tanks should be considered the minimum to guarantee the desired mean residence

time distribution for all the slurry entering the circuit. Tanks are usually interconnected in such a manner that any tank can be bypassed for maintenance. In some circumstances two stage circuits may have advantages for leaching difficult ores at relatively high acid concentrations. This arrangement requires an additional solid-liquid separation step and recirculation of highly acidic liquor to contact fresh ore.

A wide variety of reagent addition schemes have been adopted, often without any real consideration of the optimum arrangements. In some mills all the reagents are added at the head end of the leach circuit, and in others, both acid and oxidant are distributed throughout almost all the tanks. Ideally the circuit should be operated at constant acidity and temperature, unless the gangue is very unreactive, to maintain those conditions that achieve the greatest selectivity of uranium dissolution versus gangue reaction.

In practice, constant conditions can be approached by adding acid to 40 to 60% of the leaching tanks to maintain the circuit acidity within the desired operating window. For high pH circuits the pH value should not be allowed to increase above 2.0, in order to avoid precipitation of ferric and other ions. The acidity of the final leach liquor must also be sufficiently high to prevent reprecipitation of uranium. The temperature and concentrations of solution components will determine the pH value at which precipitation will occur. If  $U^{4+}$  remains in solution because of the presence of reducing minerals when all of the oxidant has been consumed, a phosphate and an arsenate will precipitate at a pH value below 1.2. Uranyl arsenate precipitates in the pH range 1.3 to 1.7, and the phosphate at pH values between 1.9 and 2.5 [5.39]. The possibility of causing reprecipitation of uranium when washing the tailing must also be considered. Uranyl arsenates and phosphates do not form when excess ferric iron is present in solution since the iron tends to tie up the arsenate and phosphate ions in the form of strong complexes.

If steam injection is used for heating, additional injection points should be placed so that the temperature variation in the circuit is no more than 5 to 8°C. The leaching time is obviously dependent on many factors (e.g. mineralogy, grind size, temperature, acidity), but the residence time should be regarded as a relatively cheap 'leaching reagent' that can enhance the selectivity for uranium and recover uranium that would be potentially lost if tight control of the leaching conditions was not achieved in a circuit with a lower residence time. However, it should be remembered that agitation in leaching can consume 25-33% of the electrical energy in a uranium mill [5.40].

Maintenance of constant oxidizing conditions is not as critical in terms of gangue dissolution, but a relatively flat profile is desirable so that the effect of the ORP on extraction can be more readily assessed.

#### 5.4.1.4. Acid addition

Many techniques have been used to control the addition of acid to leaching circuits. These include the following three methods:

- (a) Automatic control of pH,
- (b) Automatic control of free acidity through conductivity readings,
- (c) Fixed acid addition.

From earlier considerations, all methods should involve additions to more than one tank. Method (a) is the best approach if the pH value of the leach is greater than 1.8, but direct measurement has proved to be unsatisfactory because of the unreliability of industrial pH probes in a slurry medium. The leach circuits of the Ranger and Mary Kathleen mills in Australia were initially operated in this manner, but the pH electrodes were found to require almost constant attention [5.37].

Method (b) has been used at many mills with generally good results. Because the conductivity readings are less sensitive than the pH ones, and are also influenced to some extent by concentrations of other ions apart from  $H^+$ , this approach is more suitable for pH values less than 1.8.

The use of the conductivity method was developed and first applied in South Africa [5.12]. Full scale plant trials showed that conductivity control maintained the free acid level at  $6.8 \pm 0.4$  g/L, compared with between 2 and 10 g/L by normal methods of control [5.41]. Long term use at an Australian mill has confirmed the reliability and robustness of this technique [5.9]. Conductivity control consistently gave a constant pH value ( $\pm 0.05$  units) over the pH range from 1.3 to 1.7 at  $40^\circ C$  for an acid addition of 45 kg/t ore. In this instance the probes were simply washed down once per shift. The consistency of the conductivity measurement is a function of temperature, variations in leach liquor composition, buildup of scale and physical orientation of the probe relative to the flow of slurry.

Conductivity will be a less reliable indicator of free acidity for changes in ore types. This problem has been overcome at the Bessines mill, where an on-line system for the measurement of free acidity by titration has been installed [5.42]. A pulp sample is automatically withdrawn from the leach tank and filtered directly through a polypropylene medium. Filtration can be either direct or based on crossflow microfiltration technology. To minimize fouling, the sampler is equipped with a device that sequentially cleans the filter cartridge, so that the cartridge has to be changed only once per week. A titrimetric method of analysis is used, after complexation of the hydrolysable ions by a solution of potassium oxalate. The Compagnie générale des matières nucléaires/SEPA has developed a reliable method for free acidities in the range from 10 to 60 g/L; for lower concentrations further laboratory testing is considered to be warranted. On-line measurement and control has been in operation at Bessines since 1987.



Fixed acid addition (method (c)) is used where reliable operation of pH or conductivity probes cannot be achieved. If the ore grade and gangue mineralogy are consistent this method will give a reasonable leaching performance, but seldom a consistent optimum. Where fixed acid addition is used, the best operating philosophy is to aim for a specific pH or free acid profile and to adjust the acid addition rate with change in ore type to achieve this profile. The leach circuit conditions should be monitored on a daily basis to determine whether adjustments to the acid addition rate are required. To operate effectively, the total acid addition rate to the leach circuit should be automatically adjusted for any changes to the ore feed rate to maintain the desired input (kg acid/t ore) to the circuit. The total acid flow to the circuit can be divided between the individual tanks as desired.

Fixed acid addition can never consistently produce optimum leaching conditions. If oxidant requirements are continually changing the leach acidity will also vary accordingly, and considerable changes in leach conditions can occur, in particular for high pH (about 1.8) leach circuits.

Irrespective of the method of acid control, adequate mixing must be provided in the surface regions of the tanks where reagents are added to avoid local regions of high acidity and temperature that will needlessly consume gangue minerals. Likewise, measuring probes must be located in regions of good mixing; the outlet upcomer is frequently used for this purpose. The same considerations also apply to steam injection.

#### 5.4.1.5. *Oxidant addition*

Oxidant is added to one or more tanks to maintain the value of the ORP within the desired operating range (typically between 475 and 425 mV relative to a saturated calomel electrode). Industrial ORP probes are quite reliable, provided that regular (once per day) cleaning and calibration are carried out, and are used to control the addition of oxidant automatically.

Maintenance of constant ORP is not as critical, in terms of gangue reactions, as acidity. However, a relatively flat ORP profile is desirable so that the effect of ORP on extraction can be readily assessed. In addition, the variation in oxidant demand for different types of ore is often significantly more than the change in acid demand, so that inadequate control of oxidant can result in significant wastage. For this reason the practice of fixed oxidant addition should be avoided.

The purpose of maintaining a specific ORP is to ensure that there is an adequate ferric ion concentration in solution. The ORP is related to the ferric/ferrous ratio by the Nernst equation, Eq. (5.9). The logarithmic relationship of the Nernst equation has important implications for the control of the redox potential. A variation of  $\pm 20$  mV at 500 mV will not significantly affect the oxidant consumption or the uranium extraction whereas at 400 mV the same fluctuation could more than double the oxidant usage. For this reason it is important to be aware of the various types

of reference electrode systems (e.g. calomel, silver chloride) that are used in industrial and laboratory applications [5.43]. Depending on the electrode type, the indicated ORP for the same ferric/ferrous ratio can differ by up to 60 mV.

The oxidants commonly used in uranium leaching, pyrolusite and sodium chlorate, are slow to react and make close control ( $\pm 10$  mV) of the ORP difficult to achieve. In particular, the response of the ORP measurement to sodium chlorate is unacceptably slow at moderate pH values (higher than 1.2) and temperatures less than 50°C [5.44] and it is virtually impossible to achieve acceptable control of the ORP using sodium chlorate at pH values above 1.5. For ores with a variable oxidant demand considerable wastage of the oxidant (and acid) results. Pyrolusite appears to react faster than sodium chlorate, but difficulties are frequently experienced with grinding, make-up and pumping [5.26, 5.45].

Caro's acid ( $\text{H}_2\text{SO}_5$ ) was successfully used at the Nabarlek mill in Northern Australia as a replacement for pyrolusite. This oxidant was manufactured on site by the reaction of hydrogen peroxide with concentrated sulphuric acid. Because of its greater stability, Caro's acid is a more efficient oxidant than hydrogen peroxide itself [5.46]. The use of Caro's acid resulted in the following benefits [5.9]:

- (a) Significant reduction in reagent costs.
- (b) Much better control of the redox potential; the standard deviation of the hourly mean potentials were reduced from 11 to 2 mV.
- (c) The heavy metal manganese was virtually eliminated from the process streams.

On the sole basis of the theoretical consumptions Caro's acid will probably be more expensive than alternative oxidants (particularly sodium chlorate), but in many cases this differential would be soon recouped from the increased leaching efficiency and from there being less wastage of the oxidant resulting from much better control of the leaching conditions. Caro's acid was also chosen for another uranium project in Australia, which has yet to be developed. There have also been some recent developments in the technology for the on-site manufacture of Caro's acid that will significantly reduce the capital cost of the equipment for its production.

#### 5.4.1.6. Ferric sulphate leaching

The term 'ferric sulphate leaching' is slightly misleading as all acid leaching of tetravalent uranium relies on the presence of ferric sulphate as the primary oxidant. Ferric sulphate leaching refers to the technique of significantly increasing the concentration of ferric ions in the leach liquor. Ideally the spent ferrous sulphate solution is reoxidized in a separate step.

After comprehensive investigations of the reaction mechanisms and kinetics of the leaching of uraninite [5.10, 5.11, 5.47], the costs of increasing the temperature and ferric ion concentration (the Felix process) to improve the extraction of uranium

from South African ores were assessed [5.41]. Tests showed that an iron concentration of 7 g/L achieved a uranium extraction of 93% compared with between 80 and 85% obtained by conventional leaching using manganese dioxide as oxidant. The ferric ions can be recycled via auto-oxidation of a barren solution with sulphur dioxide, or by the use of a bacterial film in the presence of dissolved oxygen; this technique eliminates the need for sulphur dioxide and is very cheap [5.36, 5.41].

Pilot plant tests using bacteria (the Bacfox process) by General Mining at its Buffelsfontein gold-uranium plant, indicated that the process should increase the extraction of uranium from 76 to 80% and also cut the operating costs by 8%. In the Bacfox system, filtered leach liquor is passed through a tank where ferrous ions are oxidized to ferric ions and the liquor recycled to the leaching stage. In the tank, bacteria are grown on a honeycomb-like block of ribbed plastic, which is completely submerged in the ferrous sulphate solution. Atmospheric air is sparged into the solution by an aerator, which also ensures agitation. The temperature and pH are 30°C and 1.8, respectively [5.48]. Subsequent plant performance matched pilot plant results.

Ferric sulphate leaching has been successfully employed at the Rossing mill [5.49]. Early plant performance data showed that high ferric ion concentrations were necessary to achieve optimum uranium extraction. Under normal conditions, ferric concentrations were generally only 0.8 to 1.5 g/L. Increasing this level to 3 g/L improved average uranium extraction by 4 to 5%.

Ferric sulphate was produced by reacting acid plant calcine with sulphuric acid at a temperature of 90 to 110°C. This reaction was controlled to give a total iron concentration of 4.5 to 6 g/L in the leach solution, whilst pyrolusite was still added when necessary to control the  $\text{Fe}^{3+}/\text{Fe}^{2+}$  ratio to a value of greater than 2. Ferrous concentrations of more than 1.5 g/L were not desirable for optimum uranium dissolution, whilst a ferric ion concentration in excess of about 3.5 g/L resulted in a deterioration in CIX plant performance. A comparison between the leaching plant performance before and after ferric leaching is given in Table 5.3. Mineralogical examinations showed that extraction was increased because of additional dissolution of uraninite, indicating that the additional ferric ion did not improve the recovery from the refractory mineralization.

After the introduction of the calcine reactors at Rossing a scheme to return the acidic solutions from the tailings dam to the leaching circuit, via the rod mill, was implemented. This action recovered uranium, significant quantities of ferric ions and some acid cheaply. The return of ferric ions already in solution reduced the utilization of the calcine reactors, effecting a saving in acid (Chapter 15).

Ferric sulphate leaching of Australian ores yielded improved rates of extraction, but no improvement in final extraction [5.14]. This result suggests that this type of leaching will only be successful where the available residence time is limited or when the role of ferric sulphate complexes as oxidizing agents is hindered by the formation of less effective phosphate complexes [5.8].

TABLE 5.3. LEACHING PERFORMANCE AT ROSSING BEFORE AND AFTER FERRIC LEACHING

Parameter	Before (first quarter 1980)	Ferric leach design criteria	After (first quarter 1982)
Ferric leach	No	—	Yes
Fe <sup>2+</sup> (g/L)	0.17	1.5	1.84
Fe <sup>3+</sup> (g/L)	1.11	3.0	3.08
Leach extraction (%)	86.0	89.4	90.9
MnO <sub>2</sub> consumption (kg/t)	1.5	0.7	1.0
Acid consumption/kg Fe <sup>3+</sup>	—	2.73	2.73

#### 5.4.2. Pressure leaching

Acid pressure leaching is applied to refractory complex ore types that cannot be economically treated under standard atmospheric agitation leaching conditions. If the ores contain sulphides these are converted to sulphuric acid and ferrous sulphate at elevated oxygen pressures. The ferrous sulphate is subsequently oxidized to ferric sulphate, which is the ideal oxidant for the dissolution of tetravalent uranium:

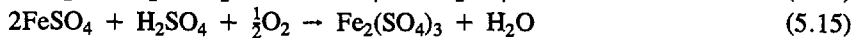
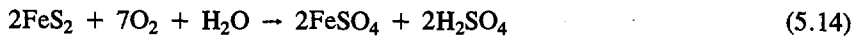

If the ores contain sufficient sulphide minerals they can be leached at high temperature and pressure without any reagent except oxygen, although the addition of a small amount of sulphuric acid may be required to initiate the reactions. In addition, at temperatures around 200°C the hydrolysis of many metal salts is much more pronounced than at lower temperatures, in particular in the case of trivalent metals, so that additional acid will be produced by this means. It seems probable, therefore, that dissolved oxygen plays an increasing role in oxidizing U<sup>4+</sup> directly since the solubility of the ferric iron decreases with increasing temperature [5.39].

The high temperature used in pressure leaching leads to efficient leaching and high recovery of uranium from refractory minerals such as brannerite and others of the mixed oxide type, but thucholite is not effectively attacked. In addition, phyllosilicates disintegrate and there is some breakdown of carbon particles, all of which release uranium particles into solution [5.36]. The applications of pressure leaching have been limited for the following reasons [5.38, 5.39]:

- (a) The materials of construction are more costly and the maintenance requirements are less well established than with atmospheric leaching.

- (b) The leaching conditions favour the formation of elemental sulphur, which coats the pipes and heat exchangers. As a result there are problems in the pumping and recovery of heat from the pulps.
- (c) The acidic ferric sulphate solutions are very corrosive at high temperatures, and strongly agitated suspensions of particles of hard rock are very abrasive.

In the former USSR an autoclave system has been successfully used to process refractory and complex low grade uranium ores. The higher temperatures and pressures, together with the use of oxygen as an oxidant, achieved improved extraction rates of uranium for lower consumptions of sulphuric acid [5.50].

Two types of autoclaves were used: a four-chamber horizontal type with a mechanical mixer and, later, a vertical type with pneumatic pulp stirring. Typical horizontal autoclaves had a capacity of 125 m<sup>3</sup> and were equipped with two stage turbine mixers, which individually sucked up and dispersed about 100 m<sup>3</sup> of air per 1 m<sup>3</sup> of pulp. However, this type of mixer proved to be very costly and accounted for about 40% of the cost of the autoclave. The absence of rotating mixing devices simplified the construction of the vertical type of autoclave, resulting in a decrease in the construction and maintenance costs, and in the energy consumption. Typical industrial units have a capacity of 100 m<sup>3</sup> and are fitted with an airlift column along the central axis of the vessel, which is used for pulp circulation. Air is supplied through a perforated plate, fitted with hoods, which is situated below the airlift column [5.50].

A process for the pressure leaching of South African ores at elevated temperatures, with air as oxidant, which resulted in the decomposition of pyrite in the ore to ferric sulphate and sulphuric acid, was successfully demonstrated in the 1950s. This method of treatment was not adopted because of the high capital cost and problems envisaged in transferring abrasive and corrosive pulps at high temperatures and pressures [5.41].

A large industry sponsored pressure leaching pilot plant (20 t/h) was subsequently operated in South Africa between 1977 and 1979 [5.36, 5.38, 5.61]. The leaching system consisted of a 20 m<sup>3</sup> capacity, four compartment, mechanically agitated autoclave and a spiral heat exchanger. Oxygen gas was used to control the total pressure at about 1250 kPa. The slurry temperature was between 160 and 180°C, and the retention time was two hours. Under these conditions uranium recovery exceeded that from conventional leaching by 12 to 15% of the total uranium content. Depending upon the refractory nature and sulphur content of the ore the acid consumption was very low, usually from 5 to 10 kg/t ore.

The mild steel autoclave was lined with lead and acid proof bricks and each compartment was agitated by a single four bladed, radial flow impeller. The slurry cascaded over brick vee notches between compartments. Steam, oxygen and concentrated sulphuric acid were injected below the gas-slurry interface. Acid concentrations were up to 15 g/L H<sub>2</sub>SO<sub>4</sub>.

A very substantial development programme was necessary with research into suitable materials for use in the construction and detailed equipment design features. After commissioning, all piping and components that were subjected to temperatures above 120°C, which were originally of 316L stainless steel, were replaced by 2RK65 or 904L stainless steel. The most serious erosion wear occurred on the impellers of the agitators. Titanium, 904L stainless steel and carborundum were used with varying degrees of success.

Randfontein Gold Mining Company has installed a pressurized pipe reactor (originally developed by Lurgi) to treat 40 000 t per month of uranium feed-stock [5.52] the leaching takes place during the passage of the slurry through the pipe reactor. The feed slurry was pressurized to approximately 6000 kPa using a sophisticated diaphragm pump, and was then fed to the preheating section of the pipe reactor. The design of this system is similar to that described in the section on alkaline pressure leaching.

The major and most recent application of acid pressure leaching is at the Key Lake mill in Saskatchewan, Canada. At Key Lake, fairly severe conditions are required to achieve a high recovery of uranium. A first stage leaching, which is at atmospheric pressure, is used to extract uranium without the addition of oxidant, the second stage leaching is at a higher temperature under oxygen pressure to extract the balance of the uranium, some of which is held within nickel arsenides, while converting arsenic to the nearly insoluble ferric arsenate, in a form permitting reasonable solid-liquid separation [5.34].

The ore is leached in the first stage for 2 h at a temperature of 50 to 70°C, followed by leaching in the second stage with 60 to 100 g/L H<sub>2</sub>SO<sub>4</sub> in a series of up to ten autoclaves (3.3 m diameter). The autoclaves are operated at 70°C and a pressure of 650 kPa for up to 6 h [5.53, 5.54]. Overall recovery of uranium is 99.5% with up to 50% extraction obtained in the first stage leaching process.

Vertical and horizontal autoclaves were both considered at the design stage. Systems of eight vertical autoclaves and three horizontal autoclaves (four compartments each) were compared. The horizontal autoclaves were considered to have a simpler layout, requiring less piping and structural steel. Despite the slightly higher total capital cost, the vertical autoclaves were chosen because of the very good temperature control at about 70°C and a maximum of flexibility and availability for the variable Key Lake ore. The autoclaves are constructed of carbon steel and lined internally with 12 mm thick rubber. The operating volume is 23 m<sup>3</sup>.

The autoclaves are designed for continuous operation and are arranged in series, with slurry flowing by gravity through any eight autoclaves at rates varying from 17 to 66 m<sup>3</sup>/h. Oxygen is introduced into the autoclaves by spargers at a pressure of about 700 kPa and dispersed into the slurry by the agitator. The agitators (37 kW) are of the double impeller type operating at 70–110 rev./min. Shaft and impeller are made of 316L stainless steel covered with butyl rubber.

Although the pressure leach route has been chosen at Key Lake an atmospheric pressure leach was chosen for the proposed development of the similar Midwest Lake ore [5.55]. The leaching conditions were 4 h at 60°C with a terminal acidity of 50 g/L. A feature of the process was the use of Caro's acid as the primary oxidant, with sodium chlorate also being added. The uranium extraction was greater than 99%. The arsenic and metal concentrations were virtually the same as for pressure leaching.

## 5.5. CARBONATE LEACHING SYSTEMS

### 5.5.1. Atmospheric leaching

Alkaline leaching is carried out in a heated aerated pulp with air or oxygen as the oxidant at a slurry density of 50 to 60 wt.%. Leaching is normally carried out in Pachucas where, because of the height, there is a pressure of up to 150 kPa. The leaching solution typically contains 40 to 50 g/L  $\text{Na}_2\text{CO}_3$  and 10 to 20 g/L  $\text{NaHCO}_3$  and the value of the pH is maintained at between 9 and 10.5. To obtain acceptable leaching rates, the grind size is typically 70 to 80%  $-75 \mu\text{m}$ . The rate of extraction of uranium can be greatly enhanced by increasing the leaching temperature. For example, in one application increasing the temperature from 80°C at atmospheric pressure to 120°C in an autoclave at 0.5 MPa decreased the leaching time from 70 to 5 h.

There have been no plants constructed in the last ten years where alkaline leaching at atmospheric pressure has been used. The Beaverlodge mill at Eldorado, which operated from 1953 until June 1982, was the prime example of carbonate leaching. During its history many innovations were introduced to improve the economics with respect to reagent usage and heat recovery. Although pressure leaching was initially used at Beaverlodge, early indications of corrosion resulted in the decision to change to Pachucas [5.56]. A system of pressure leaching alone has been adopted at most other alkaline leaching mills [5.38].

The following description of the Beaverlodge mill illustrates the alkaline leaching system [5.57, 5.58]. The Beaverlodge ore contained 5% calcite and 0.5% sulphide, as pyrite, which is an oxygen and soda consumer. The ore was ground in carbonate solution (10 g/L  $\text{NaHCO}_3$  and 40 g/L  $\text{Na}_2\text{CO}_3$ ) but the pyrite and calcite fractions were then separated by flotation. The rougher tails from flotation was thickened to between 50 and 55% solids, carbonated with flue gas to increase the bicarbonate level to 20 g/L. Flotation agitators were used for the dispersion of  $\text{CO}_2$ . The slurry was then preheated from 35 to 90°C using three concentric heat exchangers. The first exchange was pulp-to-pulp using leached slurry, the others used condensates.

The leach circuit consisted of twenty four 250 m<sup>3</sup> Pachucas (four banks of six) to give a residence time of about 100 h. The original airlifts were replaced by mechanical agitators, which pull up-draft in 40 and 60 cm draft tubes and are driven by 11 kW motors. (The total power for the motors was approximately the same as that required to provide the compressed air.) Oxidation of the uranium was accomplished by sparging pure oxygen (99.5%) deep into each vessel. Extraction of uranium exceeded 92%.

The switch to propeller agitation had two advantages. First it increased the agitation rate (turnover/hour) by a factor of ten, and secondly the oxygen concentration was also increased. These two changes improved the uranium extraction from between 85 and 87% to between 92 and 94%. Three aspects of leaching were considered critical [5.57]:

- (a) Concentration of the leach solution,
- (b) Leach temperature, and
- (c) Oxidation.

Particle size, (approximately 70%  $-45 \mu\text{m}$ ), was not a significant variable, provided that the above conditions were correct. The leach solution concentration was controlled by the addition of lime to the solution leaving the stripper; if the concentrations were low, then less lime was added and the resulting higher bicarbonate level was converted to carbonate by adding more caustic soda. The excess caustic soda level was not changed, as this would cause problems with filtration and washing of the precipitated sodium diuranate. The control was by variation of the pH value (10.5–12) of the slurry after the addition of lime. The oxidation levels were determined using a permanganate titration technique.

Alkaline leaching has been used for many years, and is still employed in one mill, in the former German Democratic Republic. The mill capacity is reported as being around 1.5 Mt of ore per year [5.59].

### 5.5.2. Pressure leaching

Autoclave leaching has been used in many alkaline leaching operations in the USA [5.60]. Autoclave units permit higher operating temperatures, which significantly increase the leaching rates, allowing residence times of 6 to 8 h. Because the operating pressures for most alkaline leach autoclaves are usually less than 700 kPa, feed-slurry pumping has not been a major problem; however, the abrasion characteristics of the pulp should be considered carefully when the pressure let-down system is being designed [5.7].

The most recently installed alkaline pressure leaching circuit was commissioned in 1980 at the Lodève mill in France; the mechanically stirred autoclaves are constructed of stainless steel. The Lodève ore is naturally rich in carbonates (dolomite, ankerite), with a total CO<sub>2</sub> content of 7%. Leaching is effected in



TABLE 5.4. LEACHING CONDITIONS AT THE LODEVE MILL IN FRANCE

Parameter	First stage	Second stage
Leach time (h)	3	6
Temperature (°C)	145	140
Pulp density (% solids)	50	50
Carbonate concentration (g/L)	30	90

two stages at a pressure of 600 kPa with oxygen injection under the conditions described in Table 5.4.

In addition to uranium, the ore contains substantial amounts of molybdenum and carbonaceous species [5.61]. The main advantages involved with a two stage leaching operation are essentially:

- (a) To achieve a good leaching recovery by the use of high carbonate concentrations during the second stage.
- (b) To recover pregnant solutions from the first leaching stage with a weak carbonate concentration, and to reduce the concentration of carbonaceous species through the recycling of second stage solutions and the addition of lime in order to precipitate alkaline humates. The use of lime offers the additional advantage of converting existing bicarbonates into carbonates, and hence of reducing corrosion problems throughout the plant, but more specifically in the grinding mills.

Heat exchangers constructed of 316L stainless steel (located outside the autoclaves), using an intermediate coolant, are used to cool the slurry leaving and entering the autoclaves [5.62]. The pressure required for circulating the slurry (1000 kPa) is supplied by a single stage volumetric pump.

Carbonate pressure leaching in a pipe autoclave has been tested in a pilot plant operation in Denmark [5.63]. The process was developed for a strongly alkaline Greenland ore with uranium contained in the mineral steenstrupine, which is a complex sodium phosphosilicate of the rare earths. Carbonate leaching was only effective at temperatures above 240°C in a concentrated solution of NaHCO<sub>3</sub>. Under suitable oxidizing conditions, the uranium was extracted in 20 minutes at a grind size of 80% -75 μm.

A reaction temperature near 300°C, a pressure of up to 1.2 MPa, and continuous operation favoured a tubular flow autoclave with a narrow bore so that the turbulence provided mechanical agitation of the suspension. The main advantages are the following:

- (1) Short retention time,
- (2) High thermal efficiency,
- (3) Relatively low capital investment and operation costs.

The principle has been employed in Germany since 1967 for the Bayer dissolution process of bauxite and is dependent on the development of a reliable slurry feed pump. The autoclave in this work consisted of a heat exchanger, a supplementary heating zone, a main reaction zone and a pressure let-down section. The heat exchanger consisted of a 184 m long double walled pipe. The diameter of the inner pipe was 20 mm and the annular space was 5 mm across. Supplementary heating was achieved by three 45 m steam mantles. The reaction zone was composed of several sections, which could be engaged or bypassed according to the required reaction time. The total length was 1890 m and the diameter was 28 mm. On leaving the reaction zone the suspension was cooled in the heat exchanger and finally passed through the pressure reduction pipe. The construction material was all low alloy steel, with the long pipe coiled in bundles.

Three piston membrane pumps yielded a total of 3 m<sup>3</sup>/h at  $1.52 \times 10^8$  Pa. A pre-pressure of 300 kPa was provided by a circulation pump. Oxygen injection was possible at different positions along the flow path. The pressure and temperature were distributed as shown in Table 5.5. Leaching was controlled by the oxidation rate, with some ores yielding maximum extractions of 65 to 80% in 20 min.

Scale formation required regular attention. Scaling was first noticed with increasing pressure and then with a slower heat transfer. The scale consisted of sodium aluminium silicate mixed with compounds of Mn, Fe, Zn, Pb, rare earths, Th and Ra. It was removed by flushing with acid solution containing an inhibitor to prevent corrosion of the iron pipe. Erosion was negligible in the main parts of the autoclave, but wear was perceptible in the let-down pipe.

TABLE 5.5. PRESSURE AND TEMPERATURE DISTRIBUTION IN BAYER PIPE REACTOR

Component	Pressure (atm.)	Temperature (°C)
Heat exchanger (in)	100-89	20-22
Heating zone	89-79	220-225
Total reaction zone	79-59	255-245
Heat exchanger (out)	59-50	245-40
Pressure let-down pipe	50-1	40

## 5.6. STRONG ACID PUGGING AND CURING

Strong acid pugging (SAP) involves impregnating coarsely ground (1–3 mm) dry ores with a small volume, typically around 10 vol.%, of concentrated sulphuric acid (only sufficient to wet the ore) and curing at 65 to 100°C for 12 to 24 h. The uranium solubilized during the curing stage can be extracted from the ore by washing the ore as a shallow bed on a belt or pan filter, or reslurrying and solid–liquid separation by conventional methods.

The leaching conditions of SAP are more severe than dilute acid, slurry leaching. They are attractive for refractory ores which require a high residual acid concentration (up to 100 g/L) because the excess acid present in the slurry is considerably reduced. Because the water content of the leaching system is limited, the dissolution of silica will also be minimized [5.25]. In addition, the hot concentrated acid is a sufficiently strong oxidizing agent to eliminate the need for the addition of an oxidant. No fine grinding is required as SAP extracts uranium from ore at much larger particle sizes, which also simplifies the subsequent solid–liquid separation step. The quantity of water required for washing the coarse ore is less than that for a fine pulp, and a stronger pregnant solution can be produced, which allows for a reduction in size of the extraction equipment. The smaller volume of water required also makes it particularly suitable for applications in arid regions. The costs of neutralizing the barren liquor are reduced because of the reduced acid consumption. The biggest disadvantage of SAP is that it requires ore that is almost dry for the leaching step, which can be achieved only by dry grinding or drying after wet milling.

### 5.6.1. Somair and Cominak mills

The leach technique involving pugging with sulphuric acid then curing and washing is used at two treatment plants in Somair and Cominak in Niger [5.6, 5.64–5.66]. In service since 1971 and 1978, respectively, these plants treat sandstone ores containing varying quantities of clay. The principal constituents of the gangue are silica, alumina and iron oxides. Carbonates are sometimes present. The uranium is found as pitchblende, coffinite or organo-uraniferous complexes. Titanium–uranium associations have also been reported.

Laboratory investigations and pilot plant studies on the ores from Arlit (Somair) and Akouta (Cominak) have shown that a conventional sulphuric acid leaching gave inadequate recovery (between 50 and 80%). The data given in Table 5.6 compare the efficiencies of the extractions for various techniques (ore grade 0.218%).

Pug leaching or pulp leaching with a strong acidity, which requires recycling and therefore a two stage approach, gave much higher recoveries than conventional techniques. The decision to use the pug leaching process was made after numerous

TABLE 5.6. COMPARATIVE EXTRACTIONS FOR VARIOUS LEACHING TECHNIQUES

Technique	Acid (kg/t)	Oxidant (kg/t)	Recovery (%)
Conventional leaching	90	5	80
Leaching (dense pulp)	90	5	88
Leaching with strong final free acid	120	5	92
acidity (two stages)	150	5	96
Acid pugging	90	5	97

laboratory tests had shown the following disadvantages of the pulp leaching technique:

- (a) Rapid breakdown and dispersion of the clays and hence the need to work with low pulp densities,
- (b) Inherent difficulty in the solid-liquid separation,
- (c) Dissolution of large quantities of silica.

Implementation of pug leaching required new technologies for the following operations:

- (1) Impregnation of the ore with sulphuric acid,
- (2) Impregnation of the ore with the oxidant,
- (3) Pugging and curing,
- (4) Uranium dissolution and washing.

The equipment used for pugging the ore with sulphuric acid and/or the oxidant consists of a revolving drum (somewhat similar to a concrete mixer, or the granulating drum typically used in the fertilizer industry). These drums have the dimensions shown in Table 5.7.

The retention time in the drums varies from 10 to 20 min. The choice of the oxidant and its method of addition have evolved with time. When the Somair plant was initially designed, knowledge of the ore was such that no oxidant was required. However, after a few years of operation, variations in the mined ore demonstrated the need to provide additional oxidant. The addition of manganese dioxide during the dissolution phase was chosen. Approximately 5 kg/t were added and required a joint addition of sulphuric acid. Impregnation of the ore was carried out with sulphuric acid and a small amount of water in order to reach a total moisture content ranging approximately from 13 to 15%.

TABLE 5.7. PUGGING DRUM DIMENSIONS

Somair	First plant	Length,	8.25 m
		Diameter,	2.5 m
Somair	Second plant	Length,	5.5 m
		Diameter,	3.7 m
Cominak <sup>a</sup>		Length,	8.75 m
		Diameter,	2.8 m

<sup>a</sup> Two drums.

In 1978 the Cominak plant went on-stream using another process. The ore was known to be strongly reducing and required high amounts of oxidant. Sodium chlorate was selected but as it is ineffective when introduced in a highly concentrated acidic medium, the impregnation had to be carried out in two stages. In the first drum, the ore was pugged with sulphuric acid and water; this first impregnation was followed by a precuring step of approximately 20 min. During this stage, the sulphuric acid concentration decreased and the sodium chlorate required for oxidation was then added in the second drum.

In 1980 the second leaching line at Somair was designed with the objective of using sodium nitrate as the oxidizing agent. Pugging of the ore and reagents (i.e. sulphuric acid, nitrate and water in order to reach 13 to 15% moisture content) was carried out in a revolving drum. A major difficulty encountered with the implementation of the process was the collection of the NO<sub>x</sub> gases evolved. A number of predicted parameters such as temperature and saturation level in water vapour of the collected gases were not fully verified, and a number of modifications of the unit had to be undertaken before the expected performance was reached.

Curing at the first plant at Somair was carried out in a revolving drum 36 m in length and 4 m in diameter (Fig. 5.2). The mean retention time was about 3 h but varied considerably from one particle to another. In such a drum, which acted more as a drier, neither temperature nor moisture could be controlled, as they were dictated by the incoming flow of air within the tube.

In the case of Cominak, curing is carried out on belts. Pugging of the ore with sulphuric acid is followed by 'precuring' onto a horizontal belt. This belt has a length of 42 m, a width of 2.5 m and a velocity of 0.03 m/s.

At the end of the belt, the ore is discharged into a revolving drum where sodium chlorate is added, and then drops onto another curing belt that is divided into two sections, each about 160 m long. The retention time on the last section is approximately three hours.

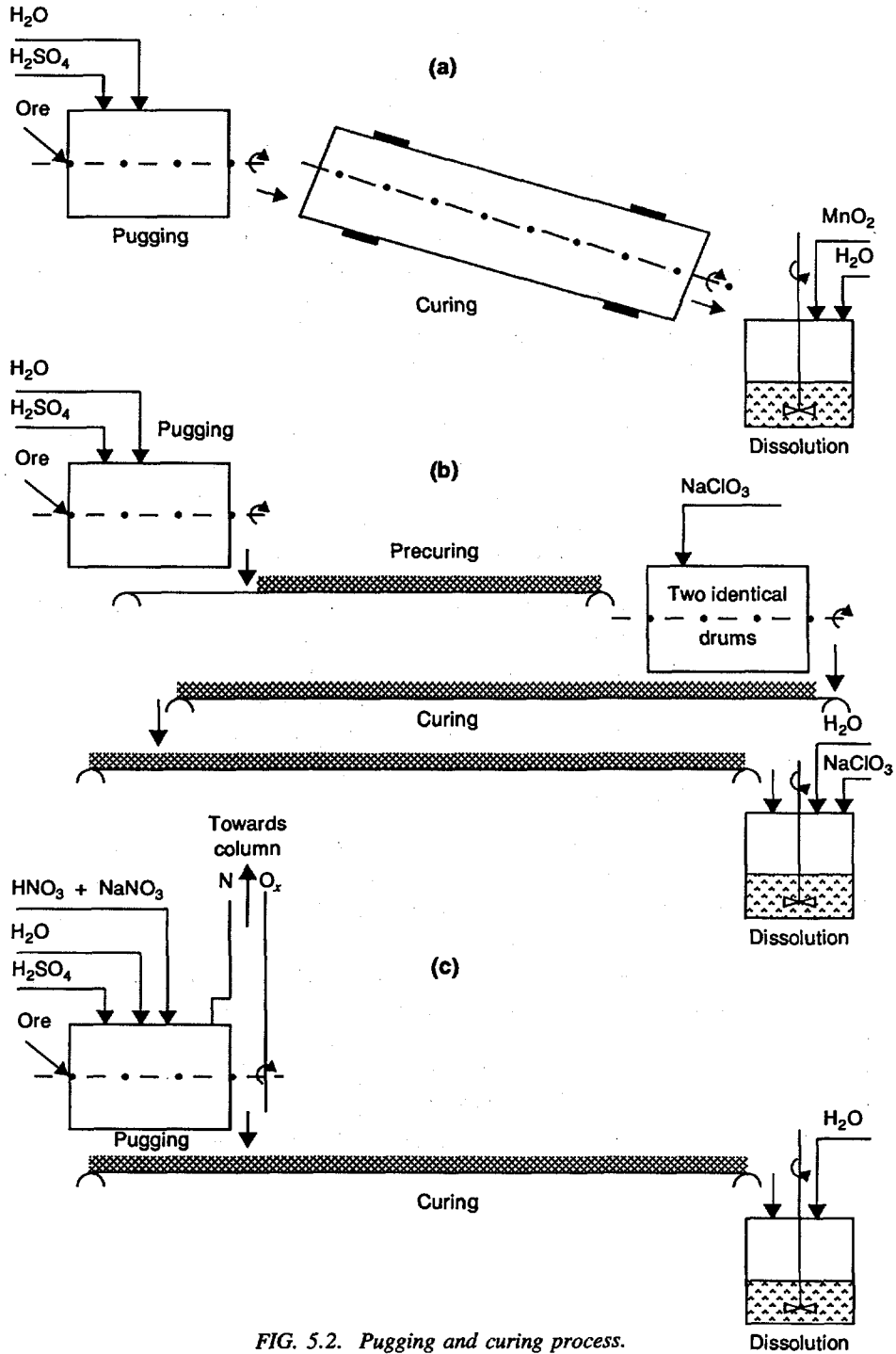

FIG. 5.2. Pugging and curing process.

A belt is also used for curing the ore at the second plant at Somair. It has a length of 195 m, a width of 2.6 m and a velocity of 0.02 m/s.

Following the curing on belts or in drums, the dissolving process is carried out in conventional agitated tanks. This operation is short, approximately one hour. Extra oxidant is sometimes added at this stage to improve extraction if the oxidation is not complete during pugging and curing.

Rotating drums are still in use for the pugging and impregnation of the ore, even though the initial design has been modified to a shorter length and an increased diameter, allowing better mixing conditions. The curing step now involves a fundamentally different type of equipment. The revolving tube at the first leach line at Somair, in addition to acting more as a drier, was found to be very sensitive to an excess of water or 'sticky' ores, and problems such as 'sticking' to the walls or agglomeration of the ore have been experienced.

The use of belts is an important new development in the 'paste leach' technology and the experience at Cominak in 1978 was successfully repeated at Somair in 1980. The selection of sodium nitrate as oxidizing agent (actually a blend of fresh nitrate and recycled nitric acid) instead of sodium chlorate was also important. The following points have been noted in favour of nitrate:

- (i) A simplified pugging step where acid and oxidant are simultaneously mixed.
- (ii) Reagent savings by recycling of nitric acid obtained from the recombination of  $\text{NO}_x$  in the column. The choice of, and the investment in, a gas collection system have been broadly justified by the reagent savings and by the reduction in transport costs achieved while using sodium nitrate at Somair.
- (iii) The serious corrosion problems experienced with chlorate and its derived compounds are thus avoided.

One limitation of using nitrates is when the maximum reduction potential achievable (approximately 500 mV) is insufficient to oxidize some compounds completely, in particular molybdenum, which is a factor in avoiding subsequent problems in downstream operations.

The head end of the Cominak plant was completely transformed at the end of 1989. Modifications involved the installation of a single pugging-impregnation unit, a column ensuring the recovery of  $\text{NO}_x$  gases, and recycling of the nitric acid resulting from the decomposition of nitrate, which is scheduled to replace chlorate as the oxidizing agent. The plant is now operating satisfactorily.

It is interesting to compare this technology with that described in Ref. [5.60] for the pugging of oxidized copper ore in Chile.

## 5.7. ALTERNATIVE LEACHING SYSTEMS

### 5.7.1. Removal of radium and thorium

Conventional sulphuric acid leaching has been found to be both efficient and economical for treating most uranium ores. The technology is relatively simple and well developed. The recovery levels of uranium are normally excellent. However, the disposition of a number of environmentally deleterious, or potentially valuable by-product, metals is not always favourable [5.60]. There are other options to reduce the potential long term problems associated with tailings disposal [5.67] in addition to changing the leaching reagent.

#### 5.7.1.1. Radium

One of the principal environmental concerns is  $^{226}\text{Ra}$ , a daughter of  $^{238}\text{U}$ . Because it behaves chemically like calcium it will be deposited in bones if ingested, and being an  $\alpha$  emitter, it is considered to be a serious health hazard. Furthermore, its decay product  $^{222}\text{Rn}$  is a short lived inert gas, which can accumulate in unventilated areas. Acceptable levels for the uncontrolled disposal of radium bearing materials varies somewhat, but current standards are in the order of 1 Bq/g for solids and 0.37 Bq/L for liquids. (Note that a value of 1 Bq  $^{226}\text{Ra}/\text{g}$  in the tailings corresponds to a uranium ore grade of roughly 100 ppm  $\text{U}_3\text{O}_8$  [5.60].)

The chemistry of  $^{226}\text{Ra}$  in the uranium milling process has been reviewed recently [5.68]. Typically, less than 1% of the radium in the ore is solubilized in the acid leaching, with the result that virtually all of the radium is discharged from the mill in the tailings. In alkaline leaching this figure could reach between 3 and 5%.

Currently, such tailings are subjected to considerable attention and control. Surface treatment and revegetation are employed to limit dusting, radon emanation and sulphide oxidation. Tailings disposal techniques are discussed further in Chapter 10 and references [5.69, 5.70]. Alternative methods of radium control include leaching the tailings in sodium chloride solution followed by precipitation with barium chloride [5.71] or treatment of the tailings to isolate a radium rich fraction for separate disposal [5.72, 5.73]. The option of conditioning tailings to minimize the long term disposal problems was comprehensively reviewed at an OECD workshop [5.67].

Another approach has been to develop an extraction technique in which radium is solubilized with uranium. Nitric acid leaching was examined in the USA and high extraction rates of uranium and radium (and thorium) were obtained. However, because of the undesirable levels of nitrate in the liquid effluents, this route has not been pursued [5.74].

Leaching with hydrochloric acid has been the subject of ongoing investigation at the Canada Centre for Mineral and Energy Technology and by other research



groups. Treating Elliott Lake ore with hydrochloric acid achieved the desired degree of radium removal (and uranium recovery), but only in the second stage of a two stage leaching operation [5.75]. Leaching in stages is necessary because the presence of sulphide minerals inhibits the extraction of radium. The process was demonstrated to be technically feasible on a minipilot scale, but a complete economic analysis was not undertaken [5.76]. High temperature chlorination of ore followed by a hydrochloric acid leach has also been shown to remove 98% of the radium [5.77].

Acid chloride leaching has also been extended to the high grade complex uranium ore from the Midwest Lake mine. The best results were obtained by preleaching with potassium chloride, followed by leaching with hydrochloric acid [5.78]. For this process the extraction rates were 99% for U, 88% for Ni, 90% for As and 98% for Ra, yielding a final residue containing 4 Bq  $^{226}\text{Ra/g}$ . In comparison, the conventional sulphuric acid route is only effective for the leaching of uranium. More than 99% of the dissolved radium could be removed by treating the HCl leach liquor with barite or with radium selective complexer resin (DFS-43230 resin of Dow Chemical) or by precipitating as  $(\text{RaBa})\text{SO}_4$  [5.79].

Ferric chloride has also been used for the extraction of uranium and radium. Radium removal was poor owing to the formation of sulphates, unless the sulphides were removed initially by the flotation method [5.80]. Radium was removed from the leach solution by adsorption onto manganese dioxide. The capital cost of the process exceeded that of a conventional sulphuric acid mill, mainly because of the more corrosive nature of the chloride solutions. The overall operating costs were calculated to be almost the same.

#### 5:7.1.2. Thorium

Thorium-232 occurs naturally in many uranium minerals and does not present particular environmental problems [5.60].

The significance of  $^{230}\text{Th}$  as a potential hazard from tailings piles lies in its long half-life (80 000 a) and in the fact that it is the immediate precursor of  $^{226}\text{Ra}$  and  $^{222}\text{Rn}$ , two of the isotopes considered to be the most environmentally sensitive. Although the solubility of Th in natural groundwaters is very low it increases rapidly as the pH value falls below 4. The thorium solubility is also enhanced by the presence of complexing ions such as sulphate. The behaviour of  $^{230}\text{Th}$  during leaching determines its ultimate form in the tailings and therefore its availability for transport should the pH value of the groundwaters fall, as is commonly observed in tailings piles in which sulphides are abundant [5.81].

The dissolution of  $^{232}\text{Th}$  is generally less than that of  $^{230}\text{Th}$ . This difference is due to the mineralogical siting of the two isotopes. Thorium-232 is often found in minerals other than the primary uranium phases, such as monazite, which are refractory under mildly acidic conditions [5.81].

Laboratory leaching of nine mineralogically different uranium ores showed that the  $^{230}\text{Th}$  extraction was always less than that of uranium (which is greater than 90%), and varied over the range from 30 to 90%, with a much greater dependence on the acidity of the leach solution. This is attributed mainly to the selective removal of thorium from the solution during leaching by pH dependent precipitation and adsorption reactions. Thus, much of the thorium retained in the acid leach tailings is present in forms in which it may be available to be leached by low pH value groundwaters [5.81].

A study of Canadian uranium mills gave similar results. The dissolution of  $^{230}\text{Th}$  was dependent on the leaching conditions and the ore mineralogy (e.g. sandstone or pebble quartz matrix). About 70% was dissolved from brannerite ores under strong leaching conditions, about 80% from ores that have low sulphur and low arsenic contents, and about 90% from complex sandstone ores containing NiAsS [5.82]. Most of the dissolved thorium precipitated (as hydroxide) when the solid and liquid wastes were neutralized before disposal [5.82, 5.83].

Leaching with hydrochloric acid would be expected to yield the same or greater extractions of thorium.

## 5.8. IN SITU AND IN PLACE LEACHING

### 5.8.1. Introduction

The terms 'in situ leaching', 'in situ mining' and 'in place leaching' have been used interchangeably. In the context of this discussion, the following definitions will be used:

- (a) *In situ leaching or in situ mining.* The ore is not moved from its geological setting. The leaching solutions are forced through the bed, usually in a horizontal direction. Typically, vertical injection wells are used to inject the leaching solutions. The pregnant leach liquors are recovered by production wells and brought to the surface for processing.
- (b) *In place leaching.* The ore is broken up by blasting, but left in underground stopes. The leach solutions may pass through the ore bed in a downwards direction or the stope may be filled with the leaching solution. The leach solutions are recovered by a collection system below the bed of broken ore.

A major advantage of the in situ and in place systems is that they operate underground; therefore, surface disturbance is minimal. Other advantages include the elimination of crushing, grinding and hauling systems, the fewer workers required, and the safer operating conditions.

Both systems are static-bed leaches, that is the ore bed remains static and the solutions circulate through the stationary bed of ore. This relationship makes the

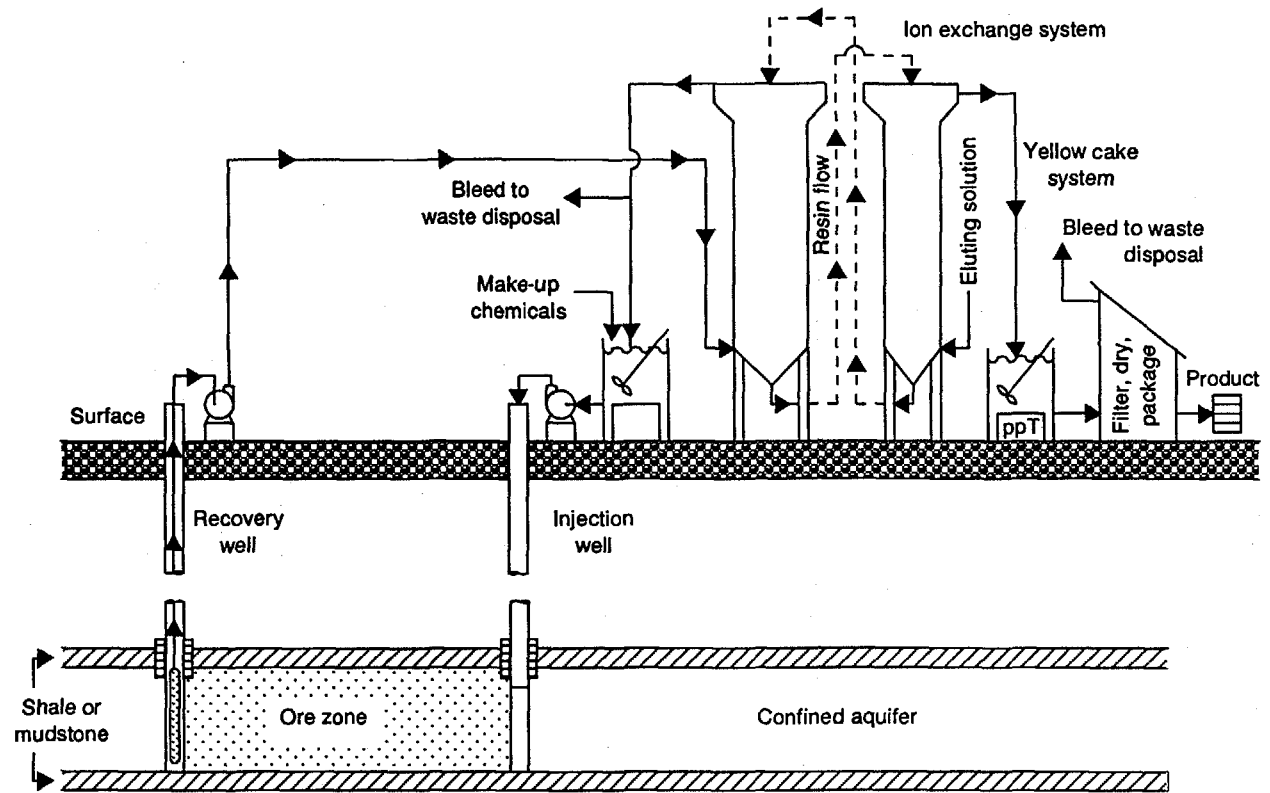

FIG. 5.3. General layout of in situ leaching operations.

distribution of solution a critical variable. The technologies virtually eliminate the handling of solid wastes, but the treatment and disposal of liquid wastes may be similar to that required for a conventional surface leaching operation. Conditions that Montgomery [5.84] has termed 'fatal flaw factors' for US operations include the presence of high concentrations of humates or organic reductants, the encapsulation of the uranium in clays, or uranium mineralization that is not amenable to leaching by the mildly alkaline solutions that are desirable for uranium extraction.

### 5.8.2. In situ leaching

In situ leaching, or in situ mining as it is sometimes called, is the newest of the static bed leaching technologies. Most of the industrial scale development has occurred during the past 15 years in the South Texas and Wyoming areas of the USA and in the former USSR. As currently practised, the in situ process consists of injecting a suitable leaching solution into the ore zone below the water table. The leaching solution contains an oxidant together with chemicals that can form uranium complexes and thereby mobilize the uranium. These leaching solutions are pumped to the surface where the uranium is recovered by ion exchange. Figure 5.3 gives a general illustration of the process.

The first commercial in situ leaching operation in the USA was operated by the Utah Construction and Mining Co. at their Shirley Basin mine in Wyoming [5.85–5.87]. This operation, which used an acid leaching technique, started in 1963 and continued until 1969 when the Utah Construction and Mining Co. developed an open pit mine at the site. The Shirley Basin deposit, as well as all of the other current commercial in situ leaching sites, are classified as rollfront type sandstone deposits. Rollfront type denotes mineralized deposits in which the uranium has precipitated out along an oxidation–reduction front. This front can have several configurations, such as the classic crescent shape, or more common tabular, dish shaped, or irregular deposits. Nearly all the commercial in situ leaching operations have been associated with shallow sandstone aquifers (less than 300 m below the surface) confined by a low permeability shale or mudstone strata. Often the relationship between size, grade and depth of the deposit has been such that open pit or underground mining technology was not economic.

Larson [5.88] has presented the following summary description on in situ mining practice in the USA:

“In general, in situ uranium leach mining consists of injecting a suitable leach solution (lixiviant) into the ore zone(s) below the water table; oxidizing, complexing and mobilizing the uranium; recovering the pregnant solution through production (recovery) wells; and finally pumping the uranium bearing solution to the surface for further processing. Various types of injection–recovery well configurations or patterns have been used in the past. The most common patterns are shown in plan

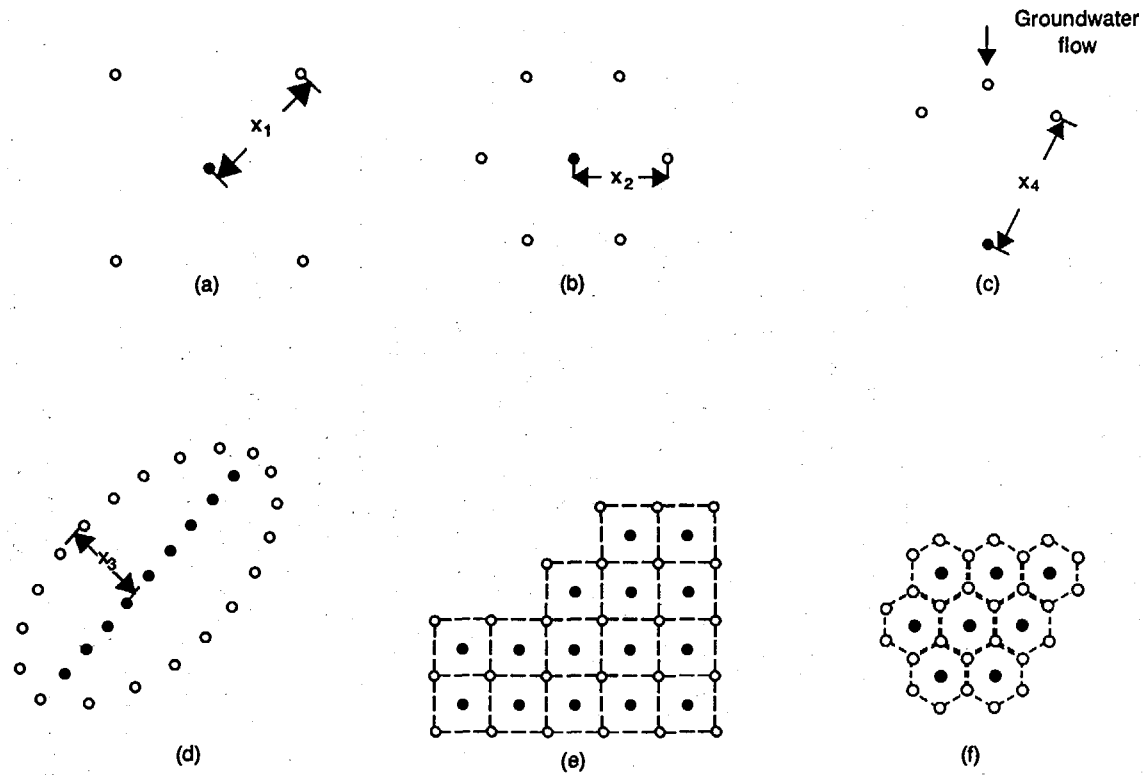

FIG. 5.4. Plan views of the common injection-recovery well patterns used in uranium in situ leach mining: (a) five spot pattern, (b) seven spot pattern, (c) Utah Construction and Mining Co. pattern, (d) ore body configuration pattern, (e) multiple five spot pattern, (f) multiple seven spot pattern. Key:  $\circ$ , injection well;  $\bullet$ , production well;  $X_1$ ,  $X_2$ ,  $X_3 \approx 9-61$  m;  $X_4 \approx 7.5$  m.

view in Fig. 5.4\*. More specifically, carefully constructed injection wells are used to inject a suitable leach solution, usually dilute concentrations of ammonium, sodium, or calcium-magnesium carbonate-bicarbonate or sulfuric acid, and an appropriate oxidizing agent, usually hydrogen peroxide or oxygen, into the uranium ore zone(s). The leach solution migrates through the permeable sandstone and comes in contact with the uranium minerals that are predominantly uranium oxides and silicates, and the oxidizer oxidizes these minerals from the +4 to +6 valance state, dissolving the mineral values. The uranium is then mobilized as a soluble uranium carbonate complex if a carbonate leach solution is used, or as a uranium sulfate complex if a sulfuric acid leach solution is used.”

Uranium recovery from an in situ leaching operation is determined by the often complex interaction of hydrology, mass transport and chemical kinetics [5.89]. Hydrological and geochemical models have been developed that describe the flow behaviour of the leaching solution and the groundwater during the development and operational phases of in situ leaching systems. Schmidt [5.90] describes the development and application of a computer model for simulating the hydrological activity associated with in situ leaching. The model is intended to provide uranium resource developers with a description of the flow behaviour of leachants and groundwater during the development, production and restoration phases of a leaching operation involving an arbitrary pattern of injection and recovery wells.

Different aquifer environments are modelled, using a closed form solution to the partial differential equation that describes three dimensional changes in the piezometric head as a result of pumping from leachant injection and recovery wells. The computer program can model a maximum of 50 arbitrarily located wells.

Numerical techniques involving difference quotients and Taylor expansions about time points are used to derive the time, velocity, areal sweep and fluid volume parameters associated with the leaching hydraulics. These parameters are given by the program in graphical and tabular formats. Other numerical methods ensure that the program running time is minimized without significantly affecting the accuracy of the results.

### 5.8.2.1. Alkaline leaching

The following equations describe alkaline leaching reactions for the ammonium and sodium carbonate leaching systems that have been used in the USA:

(a) Ammonium carbonate leach reactions [5.91],

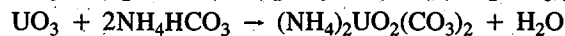
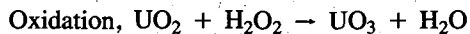

---

\* *Editor's note:* Figure 5.4 in the present book.

(b) Sodium carbonate leach reactions [5.2],

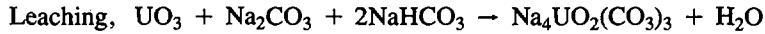
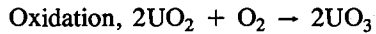

Most of the early in situ leaching operations used the ammonium bicarbonate (approximately 1 g/L  $\text{NH}_4\text{HCO}_3$ ) leaching system because the sodium carbonate-bicarbonate lixiviant caused swelling of the clay minerals associated with the Texas ores. Schechter et al. [5.92] describe a leaching system in which the potassium carbonate leaching solution is preceded by a potassium chloride preflush to prevent the permeability losses associated with the clay swelling caused by sodium. The potassium cation satisfies the exchange capacities of the montmorillonite clays without promoting swelling. Using the KCl preflush can reduce costs because KCl is a much less expensive source of potassium ions than either  $\text{K}_2\text{CO}_3$  or  $\text{KHCO}_3$ .

An even more recent development uses the leaching solutions produced by injecting pressurized  $\text{CO}_2$  and  $\text{O}_2$  directly into the existing groundwater at the bottom of each injection well (Chapter 18). The bicarbonate concentration in these leach solutions is approximately equal to that of the ammonium bicarbonate leaching system. The well depth determines the equilibrium oxygen concentration.

#### 5.8.2.2. Acidic leaching

The most extensive use of acidic in situ leaching has been made in the former USSR; the low carbonate content (0.5 to 1.0%  $\text{CO}_2$ ) of the Soviet ores favours this leaching system. Skorovarov et al. [5.93] reported that acidic in situ leaching systems were operated in the former USSR from the early 1960s. Leaching solutions containing 2 to 5 g/L of  $\text{H}_2\text{SO}_4$  are injected into the ore horizons, which are normally about 200 m below the surface. Chemical oxidants such as sodium chlorate are used. The sulphuric acid leaching system achieves uranium recoveries in the 65 to 80% range. These recoveries are about 5 to 10% higher than those produced by the carbonate leaching systems operated in the former USSR. The sulphuric acid leaching kinetics are good, which leads to higher uranium concentrations in the product solutions than those obtained in the carbonate leaching systems.

#### 5.8.2.3. Solution recovery and processing

Once the uranium minerals are complexed and mobilized, they follow the solution flow through the ore zone towards a production well where submersible pumps transfer the uranium bearing solution to the surface for processing. The uranium in this pregnant leach liquor (approximately 100 to 200 ppm  $\text{U}_3\text{O}_8$ ) is recovered by ion exchange techniques. The residual uranium barren solution from the ion exchange operation is regenerated with suitable leaching chemicals and recirculated

to the well field. Ion exchange is a cyclic operation that consists of two steps: the loading or absorption step and the elution step. During the loading step, the pregnant leach solution contacts the ion exchange resin, and the uranium is selectively absorbed. When a suitable uranium loading has been achieved the resin is cycled to the elution step. During elution, the resin is in contact with a chemical solution that strips the uranium from the resin; the resulting product solution is termed the eluate, and the eluted resin is cycled back to the loading operation. Both concentration and purification take place during the ion exchange operation. Several types of arrangements of ion exchange equipment have been used by in situ leaching operations. These include fixed bed columns that use batch type operational procedures and multiple compartment column systems that operate with semicontinuous counter-current flow of both the solutions and the resin [5.2, 5.91].

Uranium is recovered from the eluate by precipitation. The yellow cake precipitate is separated from the residual solution by thickening and filtration. The filter cake is then dried and packaged for shipment. A block flow diagram of one commercial scale in situ solution process is shown in Fig. 5.5. More detailed discussions of ion exchange and product recovery technologies are presented in Chapters 7 and 8.

Additional information on specific site processes can be found in the environmental reports that have been prepared by the various operators to meet the requirements for obtaining a source material licence [5.94–5.100].

#### 5.8.2.4. *Environmental management*

The major environmental problems associated with in situ leaching operations are the following:

- (a) The prevention and control of leach solution excursions during the mining operation,
- (b) Restoration of the groundwater conditions in the mining area after completion of the leaching operation.

In general, the industry has been able to devise satisfactory methods for controlling and minimizing solution excursions. When excursions have occurred it has been possible to correct the problem by modification of the injection and recovery pumping procedures.

Restoration of the groundwater conditions after the in situ leaching has been completed presents more difficult problems, and a significant number of both technical and regulatory questions remain [5.101]. It is quite possible that specific restoration techniques will have to be developed or adapted for each operation. A relatively simple washing operation may suffice for some deposits, while significantly more complex combinations of washing and chemical treatment may be required at other locations [5.102]. The US Department of the Interior, Bureau of Mines, and the





TABLE 5.8. TYPICAL DIRECT OPERATING COST BREAKDOWN FOR IN SITU LEACHING

Item	Per cent of total
Well field replacement <sup>a</sup>	27.0
Payroll <sup>a</sup>	17.0
Reclamation and restoration <sup>a</sup>	17.0
Royalties and taxes	14.0
Chemicals	13.0
Power	2.5
Maintenance	2.5
Others	7.0

<sup>a</sup> Major cost centres.

US Nuclear Regulatory Commission have sponsored a number of research programmes in this area [5.103–5.107].

Montgomery has cited the breakdown of direct operating costs for in situ leaching given in Table 5.8.

Achieving both low well field replacement costs and minimal restoration costs requires careful project planning. Labour costs can be reduced significantly if the satellite concept can be used. In this system the ion exchange resin is loaded at each automated satellite wellfield and then transported by road to a central process facility for product recovery.

The application of in situ leaching or mining in the USA expanded considerably during the period from 1975 to 1982, and production from this source now contributes a significant percentage of the US uranium output. In 1989 it constituted about 950 t U, which is approximately 18% of the US uranium output for that year. It now appears that if the geological setting is suitable, the technique offers a viable alternative for recovering uranium from a significant range of uranium ore grades.

### 5.8.3. In place leaching

Bacterially assisted in place leaching of the uranium remaining in worked out underground stopes has been used for many years in the Elliot Lake area of Canada [5.108, 5.109]. The sulphide content of the rock provides a nutrient for the bacteria, which converts the sulphide to sulphuric acid. Both precipitation and ion exchange

techniques have been used to recover uranium from leaching solutions. The in place leaching operation is part of an overall system for the treatment of mine waters; the system has produced both economic and environmental benefits.

The operation by Denison Mines Limited has been particularly effective [5.110–5.113]. The ore body is a uraniferous pyritic quartz bed conglomerate that occurs as reefs. Low grade ore (approximately 0.02%  $U_3O_8$ ), which occurs in reefs above the mining grade ore, is blasted into previously mined stopes. The broken ore is approximately 80% – 152 mm. A system of air distribution pipes is installed on the floor of the stopes prior to blasting. The stopes are then closed off with concrete bulkheads to form a large leaching vessel. Each block in the vessel contains about 50 000 t of low grade ore.

Denison Mines Limited uses a cyclic leaching procedure. Acidic mine water supplemented with bacterial nutrients containing *Thiobacillus ferro-oxidans*, an acidophilic sulphide oxidizing bacteria, is pumped into the stope to flood the ore. Once the ore is completely wetted, the stope is drained, aeration is started, and bacterial oxidation begins. After three to four weeks the stope is again flooded and then drained to harvest the bacterially solubilized uranium in the water. Within a two year time span a recovery of 70% is achievable. Product solutions containing 0.3 g/L  $U_3O_8$  have been produced by recirculating the leach solutions through two or three leaching blocks. The product solution is pumped to a surface operation where the uranium is recovered by ion exchange.

In 1977 a large (about 450 kt  $U_3O_8$  per year) in place solution mining operation commenced at the Agnew Lake location in Canada [5.114–5.117]. The ore was broken into underground stopes by blasting, and the leaching solutions were then applied to the broken ore by either spray pipes at the top of the stopes or through boreholes drilled from the lift above the stopes. Liquors were collected by a sump system below the stopes and pumped to the surface where uranium was recovered by ion exchange.

The original test work indicated that approximately 70% of the uranium could be recovered from the ore, which averaged slightly over 0.5 kg of  $U_3O_8$  per tonne of ore. This recovery, however, was not achieved owing to the larger than expected particle size of the fractured rock and solution distribution problems. The operation was discontinued during the latter part of 1979.

Wypick [5.118] has described a solution mining operation that has been conducted for over five years in the old stopes of a New Mexico uranium mine. The ore in this mine contains very little pyrite, and the leaching solutions are essentially very dilute sodium bicarbonate liquors. The bicarbonate is derived naturally and is in equilibrium with the  $CO_2$  content of the air and the carbonate minerals in the rock. The oxygen content of the solution is also in equilibrium with the oxygen content of the air, and this provides the oxidation required. The leach solutions contain about ten parts per million  $U_3O_8$  and are near neutral. An ion exchange system recovers the uranium from the leaching liquors.

## 5.9. HEAP AND VAT LEACHING

### 5.9.1. Introduction

Heap and percolation leaching can be defined as follows:

- (a) *Heap leaching.* The ore is mined and then piled over a collection system. Leach solutions are distributed over the upper surface of the heap and passed downwards through the bed of the ore. The bed may be ROM ore or coarse crushed material.
- (b) *Percolation leaching.* The mined ore is fine crushed (normally to about  $-1$  in ( $-25.4$  mm) or less) and then bedded into tanks or vats. The leach solutions are passed through the static ore in either an upwards or a downwards direction. Various types of preleaching treatment such as pelletizing have also been practised.

### 5.9.2. Heap leaching

Heap leaching is one of the oldest hydrometallurgical techniques. The earliest reported use for uranium was in Portugal during the 1950s [5.119, 5.120]. Applications of the technique have also been reported in Argentina [5.121], Canada [5.115], France [5.122], Spain [5.123] and the USA [5.124, 5.125]. During recent years more interest in this method has developed again. The reasons for this renewed interest include:

- (a) The technique can offer a relatively low capital cost method for recovering uranium from some low grade ores.
- (b) *Environmental considerations, such as the relatively low moisture content of washed sandstone tailings, can help to minimize waste disposal problems. This specific benefit, however, may not apply to heaps that contain sulphide minerals, which continue to generate sulphuric acid.*
- (c) The relatively coarse size of the tailings can help to minimize dusting and wind erosion problems.
- (d) Bacterially assisted leaching is applicable for some types of uranium ore.

#### 5.9.2.1. Heap leaching variables

Uniformity of the distribution of the leaching solution is probably the primary variable for most heap leaching operations, but other factors such as the following can also be important.

- (a) *Mineralogy of the ore.* Heap leaching is more dependent upon the mineralogy of the ore than conventional agitation leaching operations. The distribution of the uranium minerals in the ore must be considered. For example, an ore in

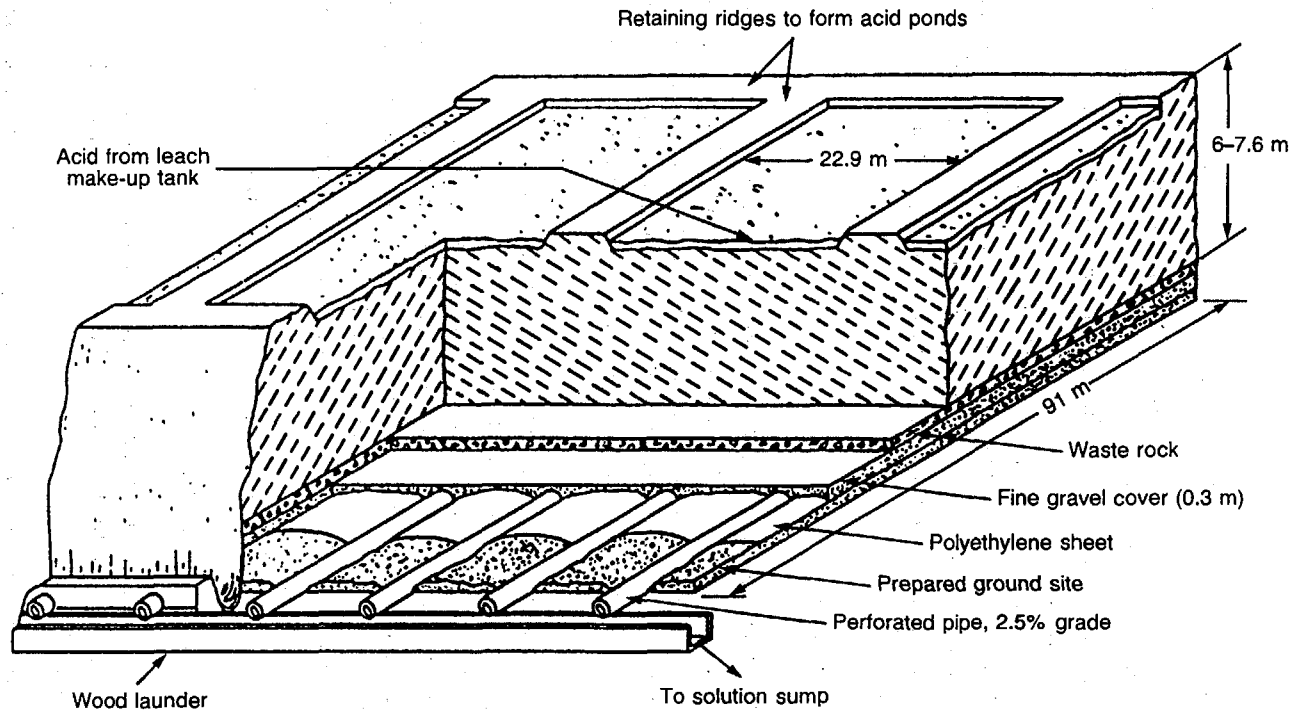

FIG. 5.6. Generic heap leach construction.

which the uranium is finely disseminated and locked up in a relatively non-permeable matrix will probably not be a good candidate for heap leaching. The carbonate and clay minerals in the ore can also be critical. Ores containing more than a few per cent of limestone may not be suitable for acid leaching. Carbonate minerals consume acid and produce  $\text{CO}_2$  bubbles that can seriously reduce the permeability of the bed. The presence of clay minerals can also affect the permeability of the heap, and the effect can vary with the type of leaching solution used. For example, it may be possible to leach an ore containing montmorillonite clays with an acidic leaching agent, but an alkaline reagent such as sodium carbonate could cause additional swelling of the clay and reduce the permeability to essentially zero. Some ores such as those found in Canada and Portugal contain significant concentrations of sulphide minerals such as pyrite. When water is present, bacterial reactions with pyrite can produce both sulphuric acid and ferric sulphate. This has sometimes been referred to as 'natural leaching' [5.119]. The mineralogy of each ore source must be considered separately.

(b) *Oxidation*. Nearly all uranium ores require some degree of oxidation during leaching, but the amount required can vary considerably. The dissolved oxygen content of the leaching solution may be adequate for a few ores, but some form of chemical oxidation is usually necessary. As mentioned above, bacterial action can also be a source of oxidation if iron sulphide minerals and proper nutrients for the bacteria are present. Bacterial oxidation of tetravalent uranium occurs primarily via an indirect mechanism. Bacteria, such as *Thiobacillus ferro-oxidans*, oxidize the pyrites within the ore, and the resulting ferric ions oxidize tetravalent uranium to the soluble hexavalent state.

(c) *Leaching reagent requirements*. In most instances the leaching reagent requirements for heap leaching will not be significantly different from the requirements for conventional agitation leaching of the same ore. For some ores, however, it has been possible to obtain good uranium extractions with relatively small reagent additions. The effect of wide variations in reagent additions should be investigated during experimental studies.

#### 5.9.2.2. *Experimental testing*

Although the mineralogy of the ore is critical it has not yet been possible to predict the heap leaching characteristics of an ore based on a mineralogical examination. Both bench scale and pilot scale testing have been necessary. The US Department of the Interior, Bureau of Mines, has conducted studies to develop a technique for evaluating the heap leaching potential of a given ore [5.126–5.129]. The equipment used for the simulations consisted of 0.6 m diameter columns constructed in sections. Ores as coarse as  $-10$  cm could be treated in bed depths ranging from 2.4 to 5.5 m with test condition variations. The experimental results were comparable with those obtained in field scale heap leaching tests.

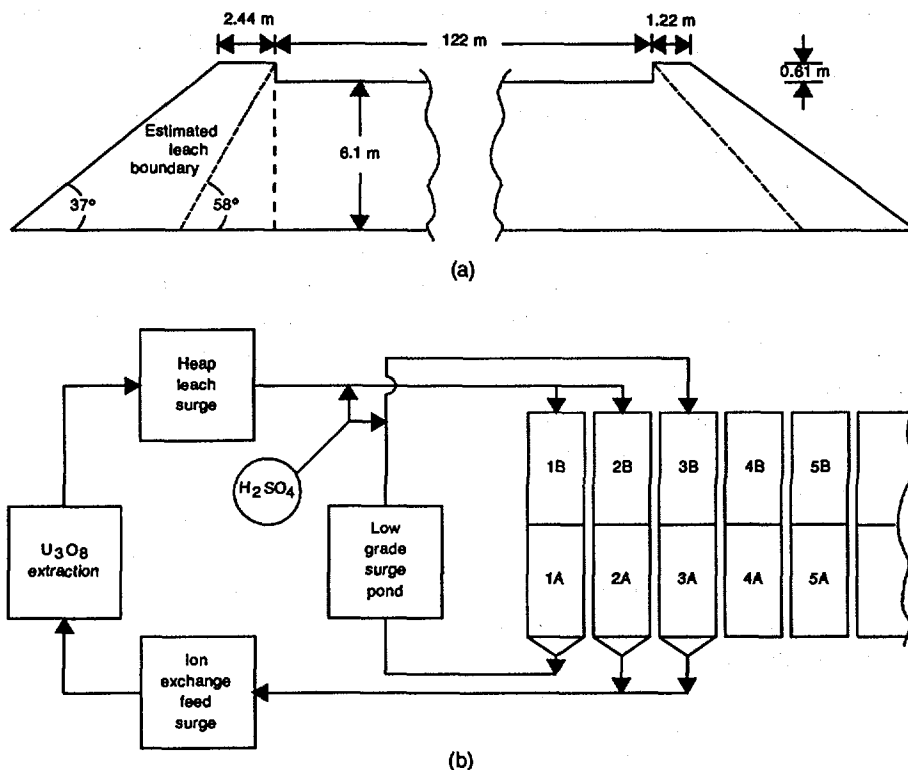

FIG. 5.7. Gas Hills heap leach; (a) cross-section, (b) layout of heap leach.

### 5.9.2.3. Industrial practice

A variety of heap construction techniques have been used for industrial scale heap leaching operations. Figure 5.6 illustrates a generic construction concept that has been used in a number of installations throughout the world [5.130]. The components include: (1) a feed solution distribution system (ponds or sprays), (2) the ore bed, (3) the leach solution collection system and (4) a containment system to prevent seepage losses. Individual operations have adapted the general concept to fit their specific needs. Figure 5.7 shows the heap size and layout used in the Gas Hills, Wyoming operation [5.124]. This operation processed an oxidized unconsolidated sandstone ore containing 0.044%  $U_3O_8$ ; the leached tails contained about 0.009%  $U_3O_8$ . Therefore, the uranium extraction in the wetted portion of the heap exceeded 85%. The overall recovery, which depends upon the percentage of the ore that is wetted, exceeded 70%. The acid consumption for this heap leach operation was approximately 10 kg of  $H_2SO_4$  per tonne of ore, and no oxidant was added.

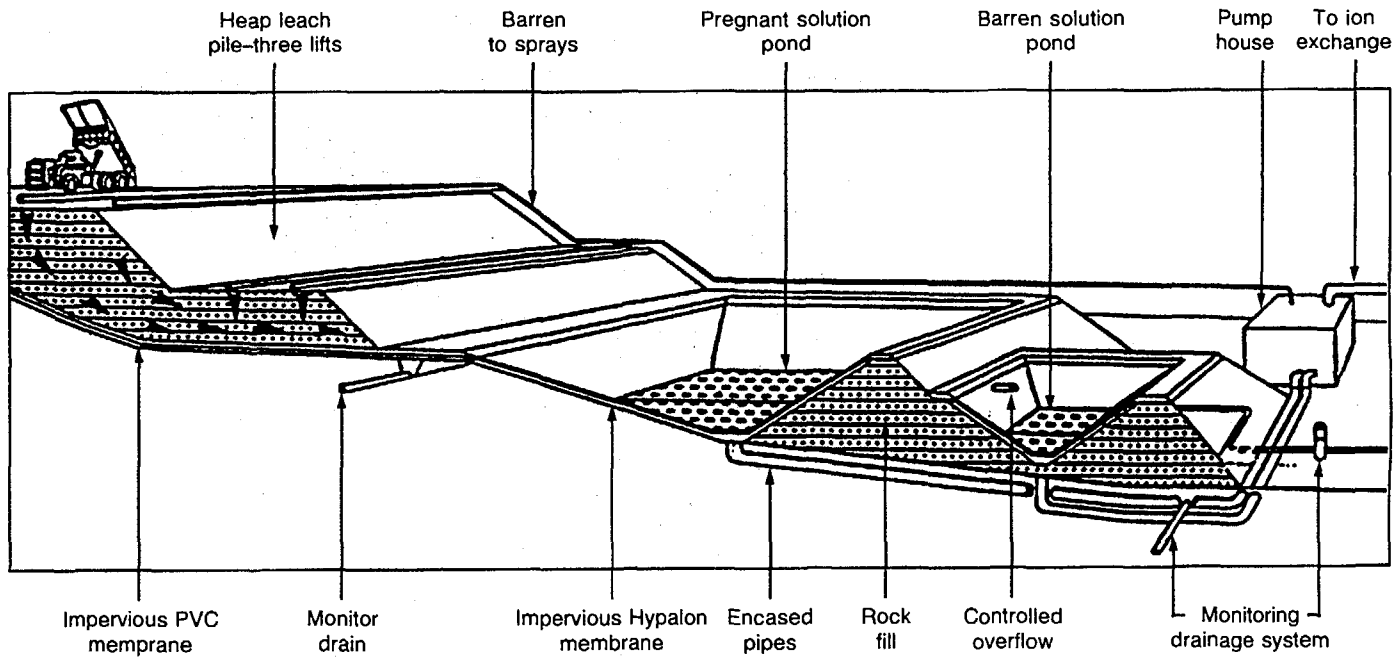

FIG. 5.8. Surface leaching operations at Agnew Lake Mines.



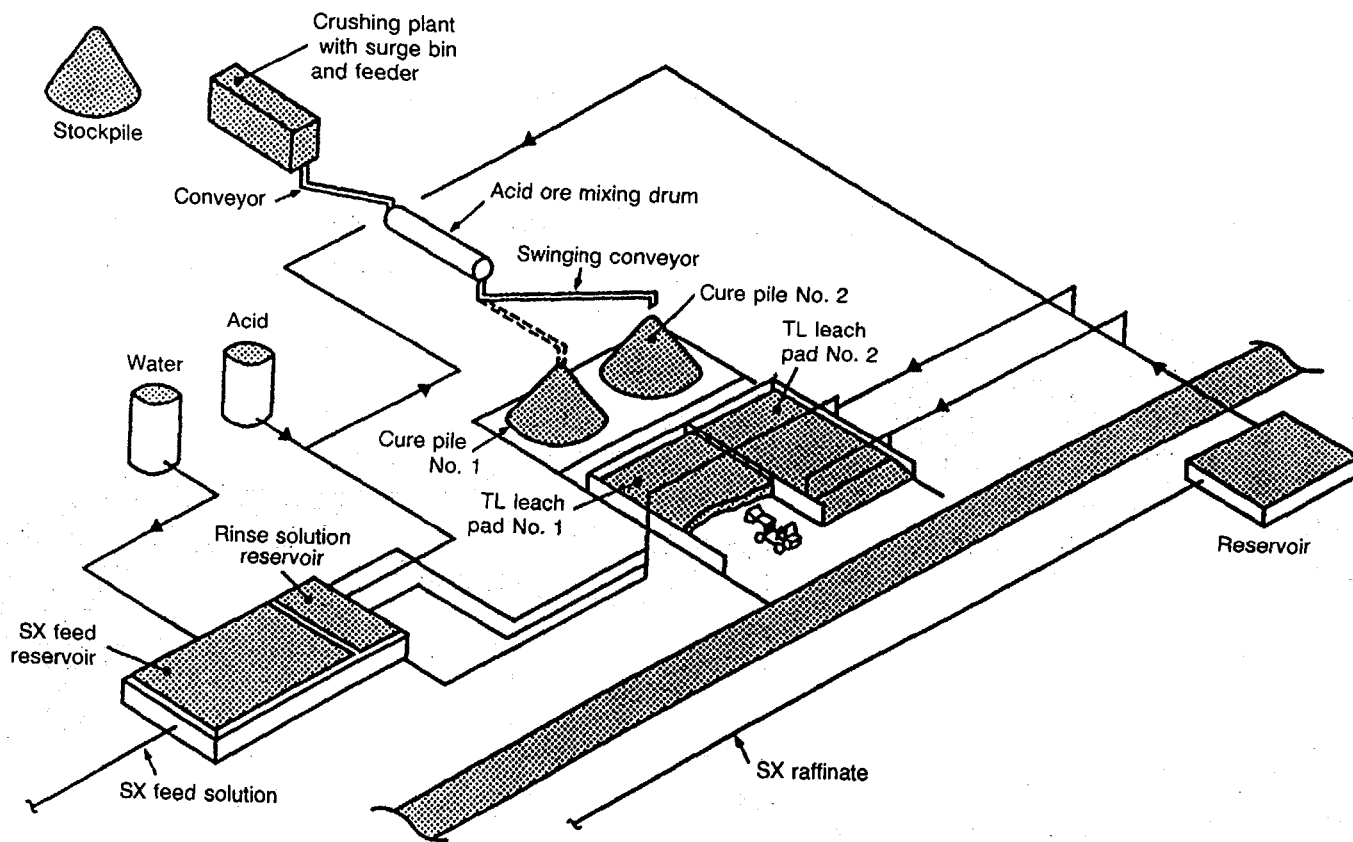

FIG. 5.9. Thin layer (TL) leaching.

Figure 5.8 shows a cross section of the surface heap leaching system used at the Agnew Lake Mines operation in Canada. The quartz pebble conglomerate ore used in this heap leaching system was the swell removed during underground development in preparation for a subsequent in place leaching operation. The ore, which contained less than 0.1%  $U_3O_8$ , was crushed to  $-7.4$  cm before being placed in the heap. Bacterial action with the pyrite and pyrrhotite components of the ore produced the acid and  $Fe^{3+}$  required for leaching. Available information suggests that recoveries were in the 70% range.

### 5.9.3. Vat leaching

Percolation leaching in vats has been used in a few uranium mills. A modified technique, which has been designated as 'thin layer leaching', can also be classified in this general category. Most of the early uranium operations that used the salt roasting process to recover vanadium and uranium from carnotite ores used some form of percolation leaching in vats [5.131]. The technique has been used on the Ranstad shales and also on a sandstone ore at the Spook operation in Wyoming [5.132-5.134]. In the Spook operation the  $-19.05$  mm broken ore (approximately 0.13%  $U_3O_8$ ) was mixed with concentrated sulphuric acid and 10 to 12% of water in an agglomerating drum. The Spook ore contained approximately 1.5%  $CaCO_3$ ; the sulphuric acid additions averaged 35 kg/t of ore. The pellets that formed were bedded into rectangular vats and leached by a percolation technique. The entire treatment cycle required 72 h; recoveries ranged from 85 to 90%.

The thin layer leaching procedure is an adaptation of the agglomerating approach in which the pellets are leached in relatively thin layers that have been placed on an impervious pad. The leach solution is sprayed onto the surface of the pellet bed. A schematic diagram of the layout is shown in Fig. 5.9. The process has been described by Brimm and Johnson [5.135, 5.136].

Since the distribution of the solution can be controlled during percolation leaching, the uranium recoveries are good and tend to be higher than the recovery achieved during heap leaching. The capital and operating costs, however, tend to be higher. Percolation is probably most applicable for small, relatively isolated ore bodies that are of at least medium grade.

## REFERENCES

- [5.1] JAMES, H.E., SIMONSEN, H.A., "The significance of ore-processing technology in the assessment of the uranium supply outlook", Uranium Supply and Demand (Proc. Symp. London, 1978), The Uranium Institute, London (1978).
- [5.2] MERRITT, R.C., The Extractive Metallurgy of Uranium, Colorado School of Mines Research Institute, Johnson Publishing Co., Boulder, CO (1971) 576.

- [5.3] SIMONSEN H.A., BOYDELL, D.W., JAMES, H.E., "The impact of new technology on the economics of uranium production from low-grade ores", Proc. 5th Annu. Symp. London, 1978, The Uranium Institute, London (1980) 92-178.
- [5.4] DUCHAMP, C., DANIGO, C., GILO, C., POLGAIRE, J.-L., SAVIN, B., "The uranium mill of the Compagnie Minière Dong-Trieu: Project preparation and implementation", Development of Projects for the Production of Uranium Concentrates (Proc. IAEA Tech. Committee Mtg Vienna, 1985), IAEA, Vienna (1987) 113-124.
- [5.5] DERRY, R., "The extraction of uranium from ores", Effective Management of the Nuclear Power Fuel Cycle — European Aspects of the Technology and Economics of Uranium (Proc. Conf. 1978), International Business Communications Ltd (1978).
- [5.6] GABILLAT, L., MOURET, P., BOUTONNET, G., GRENIER, J., POITTE, J., Du laboratoire à la marche industrielle: l'usine chimique de la Somair au Niger, Rev. Ind. Miner. (1974) 98-124 (supplement).
- [5.7] INTERNATIONAL ATOMIC ENERGY AGENCY, Significance of Mineralogy in the Development of Flowsheets for Processing Uranium Ores, Technical Reports Series No. 196, IAEA, Vienna (1980).
- [5.8] GOLDNEY, L.H., HARTLEY, F.R., McMAHON, R.G., "Notes on technical aspects of problems connected with the treatment of several new-generation Australian uranium occurrences", Uranium Ore Processing (Proc. IAEA Advisory Group Mtg Washington, DC, 1975), IAEA, Vienna (1976) 93-105.
- [5.9] RING, R.J., VAUTIER, F.E., LUCAS, G., FULTON, E., WATERS, D.J., "Performance of Caro's acid as an oxidant at the Nabarlek mill", Advances in Uranium Ore Processing and Recovery from Non-Conventional Resources (Proc. IAEA Tech. Committee Mtg Vienna, 1985), IAEA, Vienna (1985) 17-40.
- [5.10] LAXEN, P.A., A Fundamental Study of the Dissolution in Acid Solutions of Uranium Minerals from South African Ores, Rep. NIM-1550, National Institute for Metallurgy, Randburg, South Africa (1973).
- [5.11] NICOL, M.J., NEEDES, C.R.S., FINKELSTEIN, N.P., "Electrochemical model for the leaching of uranium dioxide: I — acid media", Leaching and Reduction in Hydrometallurgy (BURKIN, A.R., Ed.), Institute of Mining and Metallurgy, London (1975) 1-11.
- [5.12] SOMMER, G., OMRDOD, G.T.W., CHAIX, R.P., Recent developments in the instrumentation and automation of uranium processing plants, J. S. Afr. Inst. Min. Metall. **74** (1973) 413-420.
- [5.13] BROEKMAN, B.R., WARD, B., "The modelling of the uranium leaching and ion exchange processes at the Hartebeestfontein gold mine and its role in economic plant operation", Mintek 50 (Proc. Conf. Sandton, 1984), The Council for Mineral Technology, Randburg, South Africa (1984) 551-556.
- [5.14] RING, R.J., Ferric sulphate leaching of some Australian uranium ores, J. Hydrometall. **6** (1980) 89-101.
- [5.15] RITCEY, G.M., Crudes in solvent extraction processing — A review of causes and treatment, J. Hydrometall. **5** (1980) 97-107.
- [5.16] NEEDES, C.R.S., NICOL, M.J., FINKELSTEIN, N.P., Electrochemical model for the leaching of uranium dioxide: II — alkaline carbonate media", Leaching and

- Reduction in Hydrometallurgy (BURKIN, A.R., Ed.), Institute of Mining and Metallurgy, London (1975) 12-19.
- [5.17] ELEVATORSKI, E.A., Uranium Ores and Minerals, MINOBRAS, Dana Point, CA (1978).
- [5.18] FRONDEL, C., Systematic Mineralogy of Uranium and Thorium, U.S. Geol. Surv., Bull. 1064, Reston, VA (1958).
- [5.19] HARTLEY, F., "Conventional processes to produce yellow cake", paper presented at Australian Atomic Energy Commission Symp. on Uranium Processing, Lucas Heights, Sydney, 1972.
- [5.20] RING, R.J., Australian Nuclear Science and Technology Organisation, Lucas Heights, unpublished reports.
- [5.21] IFILL, R.O., COOPER, W.C., Mineralogical and process controls on the oxidative acid leaching of radioactive phases in Elliot Lake, Ontario, uranium ores. I — uraninite, uranothorite and monazite, CIM Bull. **82** 925 (1989) 65-74.
- [5.22] BORN, C.A., QUENEAU, P.B., RONZIO, R.A., Processing of wolframite-cassiterite concentrate for brannerite removal, Trans. Soc. Min. Eng. AIME **258** 3 (1975) 218-221.
- [5.23] SMITS, G., "Uranium-bearing minerals in Witwatersrand rocks, and their behavior during leaching", Mintek 50 (Proc. Conf. Sandton, 1984), The Council for Mineral Technology, Randburg, South Africa (1984) 527-538.
- [5.24] TSUI, T.F., Mineralogical characterization of uranium ore to evaluate in-situ leaching prospects, Soc. Pet. Eng. J. **24** (1984) 563-574.
- [5.25] TERRY, B., The acid decomposition of silicate minerals, Part I. Reactivities and modes of dissolution of silicates, Hydrometallurgy **10** (1983) 135-150.
- [5.26] VETTER, D.A., BARKER, I.S., TURNER, G.A., A dynamic uranium-leaching model for process-control studies, J. S. Afr. Inst. Min. Metall. **89** 11 (1989) 347-354.
- [5.27] MOYER, B.A., MCDOWELL, W.J., Factors influencing the phase disengagement rates in solvent extraction systems employing tertiary amine extractants, Sep. Sci. Technol. **16** 9 (1981) 1261-1289.
- [5.28] RICHMOND, G.D., "Leaching and solvent extraction at Mary Kathleen Uranium Limited", Proc. Mill Operators Conf., Institute of Mining and Metallurgy, Sydney (1978) 285-293.
- [5.29] FLÖTER, W., "The acid pressure leaching process for the Key Lake project, Canada", Advances in Uranium Ore Processing and Recovery from Non-Conventional Resources (Proc. IAEA Tech. Committee Mtg Vienna, 1983), IAEA, Vienna (1985) 117-130.
- [5.30] MILDE, W.W., Rabbit Lake project — milling and metallurgy, CIM Bull. **82** 932 (1989) 69-75.
- [5.31] MELIS, L.A., FRASER, K.S., LAKSHMANAN, V.I., "The Midwest uranium project — Development of the milling process", paper presented at Uranium '82, 12th Annu. Hydrometall. Mtg, CIM Metallurgical Society, Toronto, 1982.
- [5.32] DUTRIZAC, J.E., MACDONALD, R.J.C., INGRAHAM, T.R., The kinetics of dissolution of bornite in acidified ferric sulphate solutions, Metall. Trans. **1** 1 (1970) 225-231.

- [5.33] CREW, R.J., "Mining and metallurgical practices at Olympic Dam, South Australia", paper presented at German Assoc. Int. Mining Conf. Bergbau, 1989.
- [5.34] GRIMES, M.E., The technological future of Canada's uranium industry, *CIM Bull.* **79** 888 (1986) 73-80.
- [5.35] RING, R.J., RAPISARDA, A., "Leaching of uranium ores with hydrochloric acid", *Extractive Metallurgy (Proc. Symp. Sydney, 1977)*, Institute of Mining and Metallurgy, Sydney (1977).
- [5.36] BOYDELL, D.W., VILJOEN, E.B., "Uranium processing in South Africa from 1961 to 1981", *Proc. 12th CMMI Congr. Johannesburg, 1982, Vol. 2*, South African Inst. of Mining and Metallurgy, Johannesburg (1982) 575-582.
- [5.37] RING, R.J., Lucas Heights, Australia, personal communication.
- [5.38] GRIMES, M., "Uranium milling — A review of world operating experience", paper presented at Uranium '82, 12th Annu. Hydrometallurgical Mtg, CIM Metallurgical Society, Toronto, 1982.
- [5.39] BURKIN, A.R., "Extractive metallurgy of uranium", *Critical Reports on Applied Chemistry, Vol. 1*, Blackwell Scientific Publishers, Oxford (1980) 70-103.
- [5.40] CAMPBELL, M.C., RITCEY, G.M., GOW, W.A., Canada's uranium industry — The next decade, *CIM Bull.* **78** 875 (1985) 139-143.
- [5.41] JAMES, H.E., "Recent trends in research and development work on the processing of uranium ore in South Africa", *Uranium Ore Processing (Proc. IAEA Advisory Group Mtg Washington, DC, 1975)*, IAEA, Vienna (1976) 23-39.
- [5.42] MORET, J., MORIN, J., "On-line analysis of free acidity during the acid leaching of uranium ores", *Proc. Deuxième Congrès du Groupe Français de Genie*, 1989, Librairie Technique Lavoisier, Paris, Vol. 3, No. 7 (1989) 111-115.
- [5.43] INTERNATIONAL ATOMIC ENERGY AGENCY, *Manual on Laboratory Testing for Uranium Ore Processing*, Technical Reports Series No. 313, IAEA, Vienna (1990).
- [5.44] MATTUS, A.J., MAGID, S.B., LOPEZ, M.F., MOBBS, D.B., A comparative study of the use of Caro's acid and hydrogen peroxide to oxidize vanadium prior to solvent extraction, *CIM Bull.* **76** 854 (1983) 102-109.
- [5.45] LUCAS, G.C., FULTON, E.J., VAUTIER, F.E., WATERS, D.J., RING, R.J., Queensland Mines plant trials with Caro's acid, *Proc. Australas. Inst. Metall.* **287** (1983) 27-34.
- [5.46] SECOMB, R.J., RING, R.J., NUGENT, A.J., "Catalytic decomposition of peroxygen compounds in uranium leaching circuits", *Chemeca 85: Innovation in the Process and Resource Industry (Proc. 13th Aust. Conf. Perth, 1985)*, Inst. of Chemical Engineers, Perth (1985) 139-144.
- [5.47] NEEDES, C.R.S., NICHOL, M.J., *An Electrochemical Model for the Leaching of Uranium Dioxide*, Rep. NIM-1380, South African National Institute for Metallurgy, Randburg, South Africa (1972).
- [5.48] Bacterial oxidation to raise uranium extraction rate, *S. Afr. Min. Eng. J.* **88** (1977) 61-63.
- [5.49] KESLER, S.B., FAHRBACH, D.O.E., "Uranium extraction at Rossing", paper presented at Uranium '82, 12th Annu. Hydrometallurgical Mtg, CIM Metallurgical Society, Toronto, 1982.

- [5.50] SKOROVAROV, D.I., "Processing of low grade uranium ores in the USSR", Uranium Ore Processing (Proc. IAEA Advisory Group Mtg Washington, DC, 1975), IAEA, Vienna (1976) 141-153.
- [5.51] BOVEY, H.J., STEWART, L.N., Pressure leaching of uranium-bearing Witwatersrand ores, J. S. Afr. Inst. Min. Metall. **79** (1979) 477-484.
- [5.52] HOLMES, J.A., "Recent experiences in the application of hydrometallurgical techniques", paper presented at Hydrometallurgy '81, Society of Chemical Industry, Manchester, 1981.
- [5.53] FLÖTER, W., "The Key Lake project", Development of Projects for the Production of Uranium Concentrate (Proc. IAEA Tech. Committee Mtg Vienna, 1985), IAEA, Vienna (1987) 79-91.
- [5.54] MAYCOCK, A.R., NEVEN, M.G., Design, construction, commissioning and operation of the Key Lake uranium mill, Trans. Inst. Min. Metall., Sect. C, Miner. Process. Extr. Metall. **96** (1987) 21-27.
- [5.55] MELIS, L.A., FRASER, K.S., LAKSHMANAN, V.I., "The Midwest uranium project — Development of the milling process", paper presented at Uranium '82, 12th Annu. Hydrometallurgical Mtg, CIM Metallurgical Society, Toronto, 1982.
- [5.56] RITCEY, G., G.M. Ritcey and Associates, personal communication.
- [5.57] BELL, D.H., Some operating concerns in carbonate leaching, CIM Bull. (1979) 177-180.
- [5.58] FEASBY, D.G., Milling practice in Canada, CIM Special Volume **16**, 300-302.
- [5.59] Uranium Industry of Eastern Germany, NUEXCO Monthly Rep. No. 270 (1991) 22-28.
- [5.60] NUCLEAR ENERGY AGENCY OF THE OECD, INTERNATIONAL ATOMIC ENERGY AGENCY, Uranium Extraction Technology: Current Practice and New Developments in Ore Processing, OECD/NEA, Paris (1983).
- [5.61] LYAUDET, G., MICHEL, P., MORET, J., WINTER, J.M., "A new unit for purification of uranium solution in the Lodève mill", Development of Projects for the Production of Uranium Concentrates (Proc. IAEA Tech. Committee Mtg Vienna, 1985), IAEA, Vienna (1987) 55-67.
- [5.62] BODU, R., et al., "The Lodève plant: A complex alkaline process for a complex uranium ore", Mintek 50 (Proc. Conf. Sandton, 1984), The Council for Mineral Technology, Randburg, South Africa (1984) 707.
- [5.63] SØRENSEN, E., JENSEN, E., "Uranium extraction by continuous carbonate leaching in a pipe autoclave", Advances in Uranium Ore Processing and Recovery from Non-Conventional Resources (Proc. IAEA Tech. Committee Mtg Vienna, 1983), IAEA, Vienna (1985) 41-51.
- [5.64] LEGER, J.L., BOUTONNET, G., Arlit uranium mills use strong acid leach process, World Min. **27** (1974) 40.
- [5.65] SEIDEL, D.C., "Stored technology for possible use in uranium ore processing", Uranium Ore Processing (Proc. IAEA Advisory Group Mtg Washington, DC, 1975), IAEA, Vienna (1976) 79-89.
- [5.66] DOMIC, E.M., Lo Aguirre's Challenge for Scaling up New Technology in Copper Hydrometallurgy: From Concept to Industrial Application, Sociedad Minera Pudahuel Ltda, Santiago, Chile (paper also presented at AIME Annu. Mtg Chicago, 1981).

- [5.67] NUCLEAR ENERGY AGENCY OF THE OECD, Reducing the Environmental Impact of Uranium Tailings by Physical Segregation and Separate Disposal of Potentially Hazardous Fractions (Proc. Workshop Fort Collins, CO, 1981), OECD/NEA, Paris (1981).
- [5.68] SNODGRASS, W.J., "The chemistry of  $^{226}\text{Ra}$  in the uranium milling process", The Environmental Behaviour of Radium, Technical Reports Series No. 310, Vol. 2, IAEA, Vienna (1990) 5-26.
- [5.69] INTERNATIONAL ATOMIC ENERGY AGENCY, Current Practices for the Management and Confinement of Uranium Mill Tailings, Technical Reports Series No. 335, IAEA, Vienna (1992).
- [5.70] RITCEY, G.M., Tailings Management — Problems and Solutions in the Mining Industry, Elsevier, Amsterdam and New York (1989).
- [5.71] RYAN, R.K., LEVINS, D.M., Extraction of radium from uranium tailings, CIM Bull. 73 822 (1980) 126-133.
- [5.72] RAICEVIĆ, D., Decontamination of Elliott Lake uranium tailings, CIM Bull. 72 808 (1979) 109-115.
- [5.73] LEVINS, D.M., RING, R.J., DUNLOP, G., Reducing the Environmental Impact of Uranium Tailings by Physical Segregation and Separate Disposal of Potentially Hazardous Fractions (Proc. Workshop Fort Collins, CO, 1981), OECD/NEA, Paris (1981).
- [5.74] RYON, A.D., HURST, F.J., SEELEY, F.G., Nitric Acid Leaching of Radium and other Significant Radionuclides from Uranium Ores and Tailings, Rep. No. ORNL/TM 9544, Oak Ridge Natl Lab., Oak Ridge, TN (1977).
- [5.75] HAQUE, K.E., LUCAS, B.H., RITCEY, G.M., Hydrochloric acid leaching of an Elliott Lake uranium ore, CIM Bull. 73 819 (1980) 141-147.
- [5.76] HAQUE, K.E., LUCAS, B.H., Mini pilot scale hydrochloric acid leaching of an Elliott Lake uranium ore, Uranium 2 4 (1986) 327-342.
- [5.77] SKEAFF, J.M., LALIBERTE, J.J., "Continuous shaft furnace chlorination of uranium ores", paper No. 3.5 presented at CIM Conf. of Metallurgists, Halifax, Nova Scotia, 1980.
- [5.78] HAQUE, K.E., Acid chloride leaching of Midwest Lake uranium ore, Uranium 4 3 (1988) 261-273.
- [5.79] HAQUE, K.E., The leachability of radium from uranium ores, CIM Bull. (Dec. 1987) 76-82.
- [5.80] NIRDOSH, I., BAIRD, M.H., MUTHUSWAMI, S.V., BANERJEE, S., Coextraction of uranium and radium from ore with ferric chloride, Hydrometallurgy 10 (1983) 265-283.
- [5.81] JOHNSTON, R.M., LEVINS, D.M., Behaviour of thorium-230 and thorium-232 during acid leaching of uranium ores (in preparation).
- [5.82] NIRDOSH, I., MUTHUSWAMI, S.V., Distribution of  $^{230}\text{Th}$  and other radionuclides in Canadian uranium mill streams, J. Hydrometall. 20 (1988) 31-47.
- [5.83] RING, R.J., LEVINS, D.M., GEE, F.J., "Radionuclides in process and waste streams at an operating uranium mill", Management of Wastes from Uranium Mining and Milling (Proc. IAEA-OECD/NEA Symp. Albuquerque, NM, 1982), IAEA, Vienna (1982) 247-261.

- [5.84] MONTGOMERY, A.H., "Adapting uranium in situ mining technology for new commercial operations", In *Situ Leaching of Uranium: Technical, Environmental and Economic Aspects* (Proc. IAEA Tech. Committee Mtg Vienna, 1987), IAEA-TECDOC-492, IAEA, Vienna (1989) 75-96.
- [5.85] ANDERSON, J.S., RITCHIE, M.I., Solution mining of uranium, *Min. Congr. J.* 54 1 (1968) 20-26.
- [5.86] New method suggested for leaching uranium ore in-place — discussion of US Patent 3,309,140, *Eng. Min. J.* 168 5 (1967) 106-107.
- [5.87] GARDNER, J., RITCHIE, M.I., Leaching of Uranium Ore In Situ, US Patent 3,309,140, US Commissioner of Patents, Washington, DC (1967) 8.
- [5.88] LARSON, W.C., Uranium In Situ Leach Mining in the United States, Rep. 8777, US Bureau of Mines, Twin Cities, MN (1978) 68.
- [5.89] PUGLIESE, J.M., LARSON, W.C., "Uranium in situ mining research by the US Bureau of Mines — A review", In *Situ Leaching of Uranium: Technical, Environmental and Economic Aspects* (Proc. IAEA Tech. Committee Mtg Vienna, 1987), IAEA-TECDOC-492, IAEA, Vienna (1989) 37-62.
- [5.90] SCHMIDT, R. D., Computer Modeling of Fluid Flow During Production and Environmental Restoration Phases of In Situ Uranium Leaching, Rep. 8479, US Bureau of Mines, Twin Cities, MN (1980) 70.
- [5.91] MERRITT, R.C., "The metallurgy of uranium extraction", Uranium Mining Technology (KIM, Y.S., Ed.) (Proc. 1st Conf. Reno, 1977), University of Nevada, Reno, NV (1977) 41.
- [5.92] SCHECHTER, R.S., LAKE, L.W., GUILINGER, T.R., Development of Environmentally Attractive Leachants, Vol. II, Rep. No. PB 84-232669, National Technical Information Service, Springfield, VA (1984) 548.
- [5.93] SKOROVAROV, J.I., SADYKOV, R.H., NOSOV, V.D., "In situ leaching of uranium in the USSR", In *Situ Leaching of Uranium: Technical, Environmental and Economic Aspects* (Proc. IAEA Tech. Committee Mtg Vienna, 1987), IAEA-TECDOC-492, IAEA, Vienna (1989) 143-152.
- [5.94] TEXAS DEPARTMENT OF WATER RESOURCES, Nondischarge Permit No. 02051, Texas Department of Water Resources, Austin, TX (1977).
- [5.95] TEXAS DEPARTMENT OF WATER RESOURCES, Nondischarge Permit No. 02130, Texas Department of Water Resources, Austin, TX (1977).
- [5.96] WYOMING DEPARTMENT OF WATER RESOURCES, Amendment Application to Conduct a Full-Scale In Situ Uranium Leach Mining Operation, Highland Uranium Operation, Converse County, WY, Docket No. 40-8102, Source Material License No. SUA-1139, Wyoming Department of Water Resources, Laramie, WY (1972).
- [5.97] WYOMING DEPARTMENT OF WATER RESOURCES, Application to Conduct R&D In Situ Uranium Leach Mining Tests, Sweetwater County, WY, Docket No. 40-8348, Source Material License No. SUA-1223, Wyoming Department of Water Resources, Laramie, WY (1974).
- [5.98] WYOMING DEPARTMENT OF WATER RESOURCES, Application to Conduct R&D In Situ Uranium Leach Mining Tests, Converse and Natrona Counties, WY, Docket No. 40-8380, Source Material License No. SUA-1228, Wyoming Department of Water Resources, Laramie, WY (1975).



- [5.99] WYOMING DEPARTMENT OF WATER RESOURCES, Application to Conduct R&D In Situ Uranium Leach Mining Tests, Johnson County, WY, Docket No. 40-8304, Source Material License No. SUA-1204, Wyoming Department of Water Resources, Laramie, WY (1974).
- [5.100] WYOMING DEPARTMENT OF WATER RESOURCES, Application to Conduct a Full-Scale In Situ Uranium Leach Mining Operation, Johnson County, WY, Docket No. 40-8502, Wyoming Department of Water Resources, Laramie, WY (1976).
- [5.101] LARSON, W. C., "Uranium in situ leaching — mining environmental controls", Uranium Mine Waste Disposal (Proc. 1st Int. Conf. Vancouver, 1980), AIME, Lakewood, CO (1980).
- [5.102] SCHMIDT, C., "Groundwater restoration and stabilization at the Ruth-ISL test site in Wyoming, USA", In Situ Leaching of Uranium: Technical, Environmental and Economic Aspects (Proc. IAEA Tech. Committee Mtg Vienna, 1987), IAEA-TECDOC-492, IAEA, Vienna (1989) 97-126.
- [5.103] THOMPSON, W.E., et al., Ground Waters Elements of In Situ Leach Mining of Uranium, Rep. NUREG/CR-0311, US Nuclear Regulatory Commission, Washington, DC (1978) (available from US National Technical Information Service, Springfield, VA).
- [5.104] NUCLEAR REGULATORY COMMISSION, Irigary Solution Mining Project, Docket No. 40-8102, Final Environmental Service, Springfield, VA.
- [5.105] GRANT, D.C., BURGMAN, H.A., SEIDEL, D.C., "Restoration of in situ leached ores: A laboratory study of restoration reagents", In Situ Leaching of Uranium: Technical, Environmental and Economic Aspects (Proc. Tech. Committee Mtg Vienna, 1987), IAEA-TECDOC-492, IAEA, Vienna (1989) 63-74.
- [5.106] KASPER, D.R., MARTIN, H.W., MINSEY, L.D., BHAPPU, R.B., CHASE, C.K., Environmental Assessment of In Situ Mining (US Bureau of Mines Contract No. J0265022), National Technical Information Service, Springfield, VA (1979) 292.
- [5.107] GRANT, D., In Situ Leaching Studies of Uranium Ores — Phase V (US Bureau of Mines Contract No. H0262004), Rep. No. PB 81-222739, National Technical Information Service, Springfield, VA (1980).
- [5.108] FISHER, J.R., Bacterial leaching of Elliot Lake uranium ore, Can. Min. Met. Bul. 59 (1966).
- [5.109] HESTER, K.D., Rio Algom expands plant at Elliot Lake, Min. Mag. (May, 1979) 396-405.
- [5.110] INTERNATIONAL ATOMIC ENERGY AGENCY, Development of Projects for the Production of Uranium Concentrates (Proc. IAEA Tech. Committee Mtg Vienna, 1985), IAEA, Vienna (1987).
- [5.111] McCREADY, R.G.L., Underground bioleaching: Extracting from low-grade ore, Geos 3 (1986) 9.
- [5.112] McCREADY, R.G.L., GOURL, W.D., "Bioleaching of uranium at Denison Mines", Biohydrometallurgy (Proc. Int. Symp. Jackson Hole, 1989), Canada Centre for Mineral and Energy Technology, Ottawa, Ontario (1990) 477-485.

- [5.113] St. DENNIS, G., SHEIKH, A., "Underground biological heap leaching operation at Denison Mines Limited", paper presented at 8th Underground Operators Conf. Elliot Lake, Ontario, 1987.
- [5.114] HEYMAN, L., Metallurgical Aspects of the Operation at Agnew Lake Mines, CANMET Rep. No. EPR/MSL 80-158 (TR), Department of Energy, Mines and Resources, Ottawa, Ontario (1980).
- [5.115] THOMAS, R.A., Agnew Lake Mines: Taking giant step in solution mining, Eng. Min. J. (Nov. 1978) 158.
- [5.116] Solution uranium mine starts production, Min. Mag. (Sep. 1977) 191.
- [5.117] And the last from Agnew Lake, Min. J. (Sep. 1979) 259.
- [5.118] WYPICK, R., "Solution mining in old stopes", Uranium Mining Technology (Proc. 1st Conf. Reno, 1977), University of Nevada, Reno, NV (1977) 11.
- [5.119] CAMERON, J., "History of the evaluation and exploitation of a group of small uranium mines in Portugal", Uranium Evaluation and Mining Techniques (Proc. Symp. Buenos Aires, 1979), IAEA, Vienna (1980) 179-205.
- [5.120] AUDSLEY, A., DABORN, G.R., Natural leaching of uranium ores — A study of experimental variables, Trans. Inst. Min. Metall. 72 (1963) 235-246.
- [5.121] CECCHETTO, A.M., COPA, R.C., BOX, R.D., LICHA, A., STIPANICIC, P.N., "Application de lixiviation en tas (heap leaching) dans le traitement de mineraux Argentins", Peaceful Uses of Atomic Energy (Proc. 2nd Int. Conf. Geneva, 1964), Vol. 8, United Nations, New York (1965).
- [5.122] MICHEL, P., "Traitement des mineraux d'uranium à faible teneur", Uranium Ore Processing (Proc. IAEA Advisory Group Mtg Washington, DC, 1975), IAEA, Vienna (1976) 127-137.
- [5.123] JOSA, J.M., *ibid.*, pp. 41-53.
- [5.124] WOOLERY, R.G., et al., Heap leaching of uranium: A case history, Min. Eng. J. 30 3 (1978) 285-290.
- [5.125] MASHBIR, D.S., Heap leaching of low-grade uranium ore, Min. Congr. J. (Dec. 1964) 50-54.
- [5.126] MERRITT, R.C., PETERSON, H.D., WENTZ, C.N., Heap Leaching Studies on Uranium Ores, Phases I through III, US Bureau of Mines Contract No. E0252022, Rep. No. PB 261 127/AS, National Technical Information Service, Springfield, VA (1976).
- [5.127] MERRITT, R.C., PETERSON, H.D., WENTZ, C.N., Heap Leaching Studies on Uranium Ores, Phase IV, Rep. No. PB 272 716/AS, National Technical Information Service, Springfield, VA (1977).
- [5.128] MERRITT, R.C., PETERSON, H.D., WENTZ, C.N., Heap Leaching Studies on Uranium Ores, Phase V, Rep. No. PB 293 578/AS, National Technical Information Service, Springfield, VA (1978).
- [5.129] MERRITT, R.C., PETERSON, H.D., WENTZ, C.N., Heap Leaching Studies on Uranium Ores, Phase VI, Rep. No. PB 81 129752, National Technical Information Service, Springfield, VA (1979).
- [5.130] MERRITT, R.C., The Extraction Metallurgy of Uranium, Colorado School of Mines Research Institute, Johnson Publishing Co., Boulder, CO (1971) 108-119.

- [5.131] LUNDQUIST, A.Q., LAKE, J.L., History and trends of the uranium plant flowsheet, Min. Congr. J. (Nov. 1955) 37-42.
- [5.132] ANDERSON, Å., OLSSON, G., Uranium recovery from Swedish low grade bituminous shales, Nucl. Eng. Int. (Feb. 1975) 103.
- [5.133] ANDERSSON, Å., "Uranium recovery from bituminous shales at Ranstad", Uranium Ore Processing (Proc. IAEA Advisory Group Mtg Washington, DC, 1975), IAEA, Vienna (1976) 171-176.
- [5.134] MASHBIR, D.S., Heap leaching of low-grade uranium ore, Min. Congr. J. (Dec. 1964) 50-54.
- [5.135] BRIMM, E.O., JOHNSON, P.H., "New TL leaching process", paper presented at CIM Conf. of Metallurgists, Montreal, Quebec, 1978.
- [5.136] New TL leaching process yields economies for copper and uranium ores, Eng. Min. J. (Oct. 1978) 100-102.

## Chapter 6

### SOLID-LIQUID SEPARATION

#### 6.1. INTRODUCTION

Solid-liquid separations are one of the most important components of uranium processing operations. Not only can these operations represent up to 40% of the mill capital costs, but uranium losses due to incomplete washing can significantly reduce the operating profits. For example, in many operations the uranium in solution at this point carries over 90% of the total production costs.

Solid-liquid separation processes remove solids from a liquid either because the liquid or the solids are valuable or because they must be separated before disposal. Uranium milling operations implement all of these objectives. Nearly all mills have used either thickening or continuous filtration for the liquid recovery and tailings separation steps. The yellow cake product recovery operations have used not only these two unit operations but also batch filtration and centrifugation.

Various types of clarification equipment have been used to polish the solvent extraction or ion exchange feed liquors. The solids must be removed to prevent physical operating problems.

#### 6.2. CONCEPTS

Several common factors influence all solid-liquid separations; these include the following:

- (a) *Particle size and size distribution* — finer particles generally have slower settling and filtration rates. In addition, the thickener discharges are more dilute and the filter cakes contain more moisture because finer particles have higher specific surface areas. Therefore, overgrinding or excessive attrition should be avoided. Flow sheet design should carefully consider the optimum particle size that is consistent with overall plant operation and recovery.
- (b) *Solid concentration* — the required equipment sizes and costs usually decrease with increased feed slurry concentrations. This holds true for both thickening and filtration because the volume of liquid that must be handled decreases.
- (c) *Particle shape and surface characteristics* — the optimum condition is generally a spherical particle with zero porosity. Operational difficulties increase as either of the factors degrade away from the desired state. The surface chemistry also influences the required flocculant type and dosage.

- (d) *Liquid viscosity* — when the liquid viscosity increases, both the settling and filtration rates decrease. The maintenance of a steady temperature becomes particularly important in severe climates because the viscosity of water becomes increasingly significant as temperature approaches the freezing point.

While there are other factors specific to each separation step, the above represent those of primary common influence.

### 6.2.1. Thickening

Thickening, as applied in uranium processing, can be defined as removing a portion of the liquid from a slurry by allowing the solids to settle under the influence of gravity in some form of sedimentation vessel. The solids concentrate in the remaining liquid. Both conventional and high rate thickening have been widely used in the industry.

#### 6.2.1.1. Conventional thickening

In conventional thickeners the flocculated feed pulp enters through a feed well at the centre of the vessel. Clear liquor leaves the tank at the periphery, and the thickened pulp is discharged at the bottom. The solid-liquid concentrations in conven-

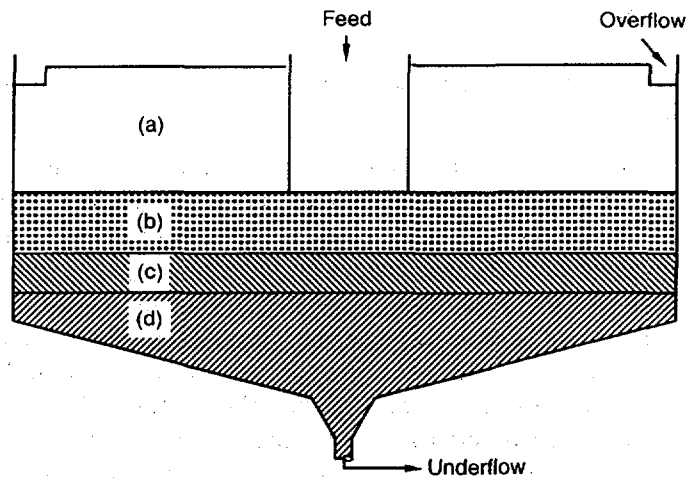

FIG. 6.1. Various zones in an operating uranium mill thickener: (a) clear solution zone, (b) mass subsidence or free settling zone, (c) hindered settling or transition zone, (d) compression or compaction zone.

tional thickener operation can be grouped into the following four zones, which are also shown in Fig. 6.1:

- (a) The clear solution zone,
- (b) The mass subsidence or free settling zone,
- (c) The hindered settling or transition zone,
- (d) The compression or compaction zone.

Not all of these zones or regimes may be present in any given thickener operation, but the thickener must be designed to accommodate every regime that does occur.

Relatively simple settling test techniques can be used to develop the data required for thickener sizing [6.1]. Simulated thickener feed is settled in a graduated cylinder. The initial feed density must be about that which will be employed in practice, and the tests must be carried out on ore that has been treated as closely as possible to the projected plant operation. As the pulp settles it passes through the zones shown in Fig. 6.1. A settling curve is produced.

In the Coe-Clevenger method [6.2], which requires that a clear interface be observable, the material is settled to its ultimate density. A portion of the clear supernatant is decanted, and the test repeated. This is done at a number of dilutions. The thickener area requirement is calculated at each dilution using the equation:

$$A = \frac{1.33(F - D)}{RS} \quad (6.1)$$

where:

- $A$  is the cross-sectional area in  $\text{ft}^2$  per dry ton per 24 h;  
 $F$  is the feed distribution, the mass ratio of liquid to solid;  
 $D$  is the underflow dilution, the mass ratio of liquid to solid;  
 $R$  is the settling rate in ft/h of the feed dilution  $F$ ; and  
 $S$  is the specific gravity of the liquid.

The largest calculated area controls and is the required design area for the thickener. Numerical examples are presented in Refs [6.1, 6.3].

In the Kynch method [6.4] only one settling curve is produced. The original pulp height is measured, and the pulp height is plotted against time during the settling period. A tangent is drawn to this curve at the point where the rate of change is a maximum. This is the critical concentration that will require the greatest unit area. The required thickener area is calculated from Eq. (6.2):

$$A = \frac{t_u}{C_0 H_0} \quad (2)$$

where

- $A$  is the unit area in  $\text{ft}^2$  per ton of dry solids per 24 hours;  
 $t_u$  is the time in days found from the intersection of the tangent to the settling curve and a horizontal line corresponding to the height of the solids at the desirable underflow concentration;  
 $C_0$  is the initial dry solids content in tons of dry solids per  $\text{ft}^3$  of feed pulp;  
 $H_0$  is the initial height in feed of the slurry.

A numerical example is presented in Ref. [6.1].

#### 6.2.1.2. High rate thickening

A key difference between conventional and high capacity thickeners is the manner in which the feed pulp is introduced into the thickener. In conventional thickeners, as was shown in Fig. 6.1, the externally flocculated feed pulp feeds into a free settling zone. High rate thickeners introduce the pulp in a different manner; Fig. 6.2 illustrates one of these feed configurations. The feed slurry enters at the top through a relatively small diameter feedwell where it mixes with staged flocculant additions in two or more gently agitated reaction zones. The flocculated pulp then flows into the settling area of the thickener below the surface of the hindered settling zone. This procedure results in minimum degradation of the flocculi. In addition, direct contact between the rising fluid and settling solids, such as occurs in the free settling zone

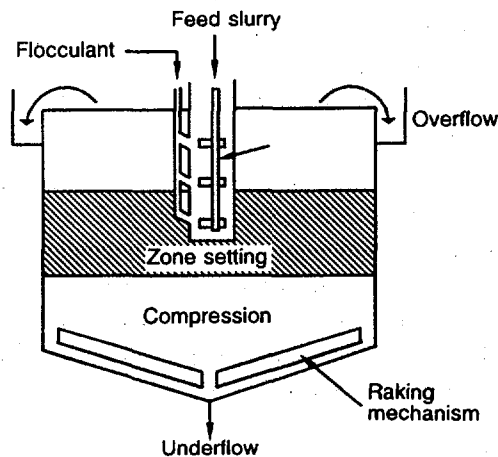

FIG. 6.2. High rate thickener configuration.

of conventional thickeners, is averted. The unit areas for high rate thickeners normally range from one quarter to one tenth of that required for conventional thickeners. There is a growing consensus that the performance of high rate thickeners relates primarily to near ideal flocculation. The solids are flocculated with minimum shear in the flocculation zone where rapid contact of the flocculant with a large amount of feed pulp is achieved. One supporting proof of this concept is that no high rate thickener has ever been installed to operate without the addition of flocculant [6.5].

Manufacturers have developed special bench scale equipment for sizing high rate thickeners. The testing for these units is best carried out with the assistance of the manufacturers since they have the specific experience that is often required.

### *6.2.1.3. Continuous countercurrent decantation*

Continuous countercurrent decantation (CCD) is the separation and washing of solids from an associated solution by repeated stages of gravity sedimentation. Thickener underflows generally contain from 20 to 60 wt% solids and therefore contain large quantities of solution. Accordingly, the underflow slurry must be diluted and resettled several times to achieve the +98% recovery of dissolved values required in uranium circuits. If fresh water were used for each separation step the pregnant liquor volume would become too large for recovery operations to be economic. CCD circuits overcome this limitation by having the solids move in the opposite direction to the washing solutions. Fresh wash water is added only to the final CCD unit. Uranium mills have used CCD circuits containing from four to eight thickeners. Circuits with eight thickeners produce approximately one tonne of pregnant solution per dry tonne of solids treated. To achieve the same washing efficiency (+98%), four thickener circuits will require considerably more wash water and produce around three tonnes of pregnant solution per tonne of dry solids treated.

Material balance calculations are required to predict the uranium recovery that can be obtained with a given number of stages with varying amounts of wash water. The data required for these calculations and the calculation procedures have been discussed in Refs [6.6, 6.7].

### **6.2.2. Filtration**

As practised in the mineral industries, filtration can be defined as the process of separating solids from liquids by a porous medium that retains the solids but allows the liquid to pass. It has been developed as a practical art rather than as a science. Filtration theory cannot be used as the sole basis for the design, but it can be valuable for interpreting laboratory tests, in seeking the optimum filtration conditions, and for predicting the effects of changes in operating conditions. Filtration



theory has been comprehensively discussed by Coulson, Richardson, Dahlstrom and others [6.8, 6.9].

Even though filtration theory is complex, a number of simplifications can be made in applying the theory to uranium processing [6.1, 6.10]. These simplifications are used in conjunction with bench scale testing procedures. The following discussion relates directly to drum filtration, but the approach can also be adapted to disc or belt filtration.

The design of vacuum drum filters is usually carried out by filter leaf testing techniques [6.3, 6.11]. In this approach a 0.03 m<sup>2</sup> filter leaf is used to determine the slurry filterability. The pretreatment of the ore must be the same as it will be in the operating plant, i.e. the same grinding and leaching conditions must be used. Once this has been done, filter leaf tests can be run on a slurry of the expected pulp density. A cloth is chosen to cover the leaf, and equipment is set up to measure the flow of air, to indicate the applied vacuum and to collect the filtrate and washes.

The first data desired are for the 'form filtration rate'. This is obtained by measuring the volume of form filtrate and the weight of cake picked up in a given time period of say 30, 60 or 90 s. The 'form filtration' rate  $Z'$  is defined as the weight of dry cake solids per unit area per hour of cake formation time. This rate will vary according to the form time used. The equation relating this rate with time is as follows:

$$Z' = K' \left( \frac{1}{\theta_f} \right)^{0.5} \quad (6.3)$$

where

$\theta_f$  is the formation time used to obtain the rate, and  
 $K'$  is a constant.

On log-log paper, the plot of 'form filtration rate' against formation time will be a straight line with a slope of  $-0.5$ .

In a drum filter the drum is partially submerged in the feed slurry contained in the filter boot. Therefore, only a part of the filter cycle will be the 'form time'. In order to estimate the full scale rate, the 'form filtration rate' is multiplied by the following factor:

$$\frac{\text{cake formation time}}{\text{total filter cycle time}}$$

The value of this multiplier will range from 0.16 to 0.33.

Washing tests are conducted to determine how much of the solute can be removed from the cake. This is done by adding a measured displacement solution

to the filter leaf after the initial filtrate has been sucked through. With uranium slurries the following equation has been established for wash recovery:

$$R = \left(1 - \frac{E}{100}\right)^n \quad (6.4)$$

where  $R$  is the percentage of soluble uranium remaining *after* washing on the basis of  $R = 100\%$  *prior* to washing,  $E = 100 - R$  at  $n = 1$  (termed the 'wash efficiency'), and  $n$  is the volume of wash fluid per unit volume of liquid in the cake prior to washing (the moisture in the cake) and is called the 'wash ratio'.

The 'wash efficiency', i.e. the amount of soluble uranium removed from the cake after one wash displacement has been applied to the cake, generally ranges from 80% or above with uranium slurries. However, an efficiency of about 70% is normally used as the design basis for a plant scale filter installation.

It is necessary to know how long it will take to apply the wash so the filter cycle and filter capacity can be tailored to the desired soluble loss. The time taken is correlated by the following equation:

$$\theta_w = (K')(\theta_f)n \quad (6.5)$$

where

- $\theta_w$  is the wash time,
- $\theta_f$  is the formation time,
- $K'$  is a constant,
- $n$  is the wash ratio.

The time required to apply the wash required to obtain a certain soluble loss determines how much washing can be done on one filter stage.

The same general approach can be used to size a belt filter operation. For these tests the filter leaf is fitted with a cylindrical collar, or a test filter similar to a Buchner funnel is used.

Additional details and alternative procedures for washing calculations can be found in Refs [6.6, 6.7, 6.9].

### 6.2.3. Flocculation

Prior to the mid-1950s solid-liquid separation was one of the most difficult problems in uranium milling operations. These difficulties gave a major impetus to the development of the basket resin-in-pulp systems in the USA. Almost simultaneously, however, the development of effective flocculants produced major improvements in solid-liquid separations. The uranium industry pioneered the application of these flocculants.

The first effective flocculants used in uranium milling operations were guar gum products, sold under trade names such as Guartec and Jaguar. Within a few years these had been, to a large degree, replaced by the polyacrylamide flocculants (Separan, Aerofloc, etc.), which have since become standard in the industry. The addition rate for these polyelectrolyte flocculants has generally been in the range of 0.04 to 0.1 lb/ton of ore (0.018 to 0.5 kg/t of ore). Stock solutions are usually made up to about 1% strength and diluted to between 0.025 and 0.05% before addition to an ore pulp stream.

The term flocculation, as used in the uranium industry, involves not only the agglomeration of particles, but also the interconnection of these particles by means of long chain flocculant molecules into large loose flocs. The mechanism of this interconnection is complex. To a significant degree it can be explained by 'bridging' theory [6.12-6.14]. The long chain polyacrylamide molecule adsorbs onto the surface of a particle, leaving a large proportion of the molecule free to be adsorbed onto another particle. This sequence forms an actual molecular linkage or 'bridge' between the particles. In practice many such bridges are formed, linking a large number of particles together.

Many factors can effect the choice of the best flocculant for a given system [6.15]. Some of these are as follows:

- (a) Type of flocculant,
- (b) Amount used,
- (c) Method of addition,
- (d) Solution reagent concentration,
- (e) Type of system (acid/alkaline),
- (f) Slurry density,
- (g) Slurry pH,
- (h) Physical nature of the solids (size, minerals),
- (i) Chemical nature of the solids,
- (j) Liquor composition (electrolytes present, etc.),
- (k) Other system additives and order of addition.

This complexity requires that the flocculation operations in uranium mills be based on careful testing. Subjective evaluations based on visual observations during 'jar' tests can often apply. In these tests the measured volumes of the slurry or suspension to be tested are placed in suitable round or square containers (jars) equipped with slow speed paddle type agitators. Measured amounts of flocculant are added at prescribed times under preset agitation conditions. The flocculation efficiencies are then evaluated sequentially as logarithmic functions of flocculant type and concentration. The effect of the intervening mixing time between the flocculant additions can be an additional variable [6.12, 6.14, 6.16, 6.17]. Recommendations on flocculants and the testing procedures from flocculant and equipment manufacturers can be particularly valuable.

### 6.3. APPLICATIONS IN URANIUM MILLING

Uranium milling operations have used nearly all of the solid-liquid separation techniques common to hydrometallurgical operations. In general, the solid-liquid separation flow sheets and concepts are similar, but almost all uranium mills contain unique features. These features often reflect the preferred design and operating experience of the mill owners.

New developments, such as high rate thickeners, flocculants and horizontal belt filters were, to a significant degree, pioneered and perfected in the uranium industry. Circuit changes have been evolutionary; most often new technology was initially used to supplement or expand existing circuits.

#### 6.3.1. General circuit descriptions

Hester has presented the following descriptions of solid-liquid separations in acid and alkaline circuits [6.1]. Since the flow sheets that will be discussed are generic, any given mill may not incorporate all the operations shown or in some cases may include additional separations.

##### 6.3.1.1. Acid leaching circuits

Figure 6.3 shows a schematic diagram of a generic acid leach circuit; the solid-liquid separation sections are outlined with bold lines.

After grinding to the required size to liberate the uranium bearing components of the ore, the ground ore is classified. This classifier overflow often has a relatively low solids content (of around 35%). Thickening or filtration (Fig. 6.3, stage A1) is often employed prior to leaching for the following reasons. Maintaining the leaching circuit acidity is important whether it be a controlled pH system or one based on free acid content. The higher the leach density (providing the pulp is still fluid) the lower the acid consumption. In addition, for a given contact time and tonnage rate, the higher the density the smaller the required leaching volume. In addition, at low densities, 'sanding out' of the agitated tanks is more probable because the pulp has a lower suspending power.

Under certain conditions reagent conservation can be practised, and sometimes improved recoveries can be obtained by a solid-liquid separation stage directly after leaching. Some circuits have installed disc filters on the acid leach discharge and returned the recovered acid to the head end of the circuit. In these operations, the acidic filter cake was repulped and sent to a partial neutralization stage (if required) or fed to the washing stage. Other circuits have used a two-stage leach with a thickener or filter after the first stage to remove the high grade pregnant liquor (Fig. 6.3, stage A2).

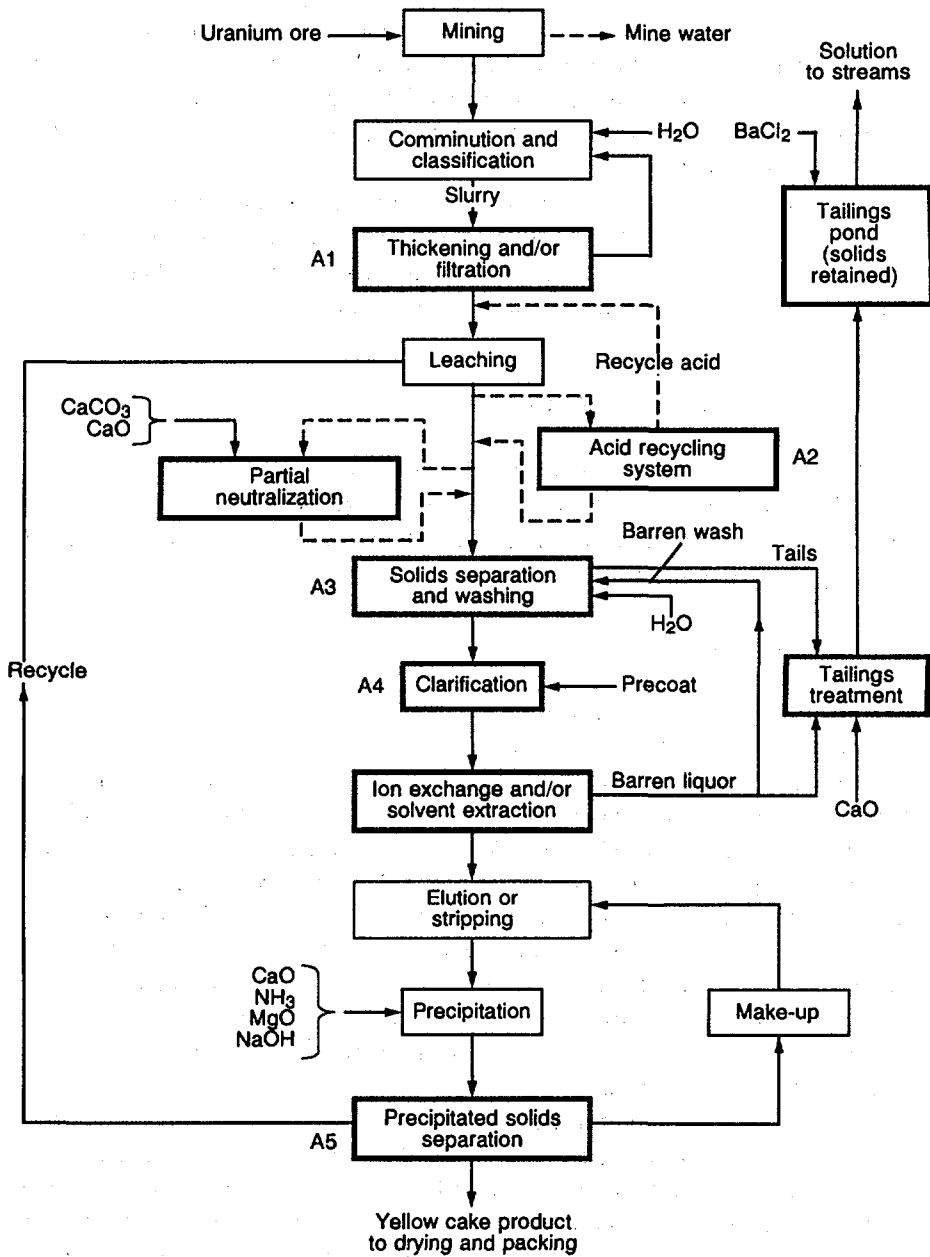

FIG. 6.3. Generic acid leach circuit.

At the completion of leaching, virtually all of the uranium has been dissolved from the ore. Subsequent uranium recovery operations necessitate that the barren solids be removed (Fig. 6.3, stage A3). The uranium in solution must be washed from these solids as thoroughly as possible. Over 90% of the production costs have been incurred prior to this stage; therefore, soluble losses from this stage are high cost losses and must be minimized.

The pregnant liquor going to either the column ion exchange or the solvent extraction should be as free of solids as possible. This restriction does not apply to resin-in-pulp circuits and may not be applicable to certain CIX processes. The pregnant liquor from thickener circuits may contain from 200 ppm up to almost 1% solids. In conventional column ion exchange circuits, which load uranium onto the resin by running solution down the flow through a static resin bed, clear solutions make for a smooth and efficient operation. If excessive particulate matter is present, column plugging can occur. In solvent extraction, the clarity of the pregnant liquor prevents high losses of the organic phase through third phase formation when the organic materials adsorb on the particulate matter and form a 'crud'. For this reason, a polishing or clarification step is installed ahead of these processes (Fig. 6.3, stage A4). The objective of this clarification is to reduce the suspended solids content to below 10 ppm.

The final step in the uranium milling operation is to recover the uranium as a high grade yellow cake product. Precipitation may be achieved in a single stage or in a double stage. All of the systems involve one or more solid-liquid separation circuits that may contain thickening, filtration, or centrifuging equipment (Fig. 6.3, stage A5). Nearly all the systems include liquor recycling to minimize reagent consumption.

The solid-liquid separations used in the tailings management systems are discussed in Chapter 10.

#### 6.3.1.2. Alkaline leaching circuits

Figure 6.4 shows a generic diagram of a alkaline leaching circuit; the solid-liquid separation sections are outlined with bold lines.

After the ore is ground it is desirable to decrease the amount of liquid in the ground ore slurry as much as possible to minimize water balance problems and conserve reagents. This can be done by either thickening or filtration of the ground ore pulp (Fig. 6.4, stage C1). The overflow solution is recycled back to the grinding circuit.

At the end of the leaching process the solids residue must be separated from the leach liquors. This has been accomplished using either rotary drum filters or horizontal belt filters (Fig. 6.4, stage C2). The soluble uranium is washed from the leached residue using recarbonated barren solution and finally fresh water. Solutions coming from the filters contain some fine suspended solids, which could contaminate

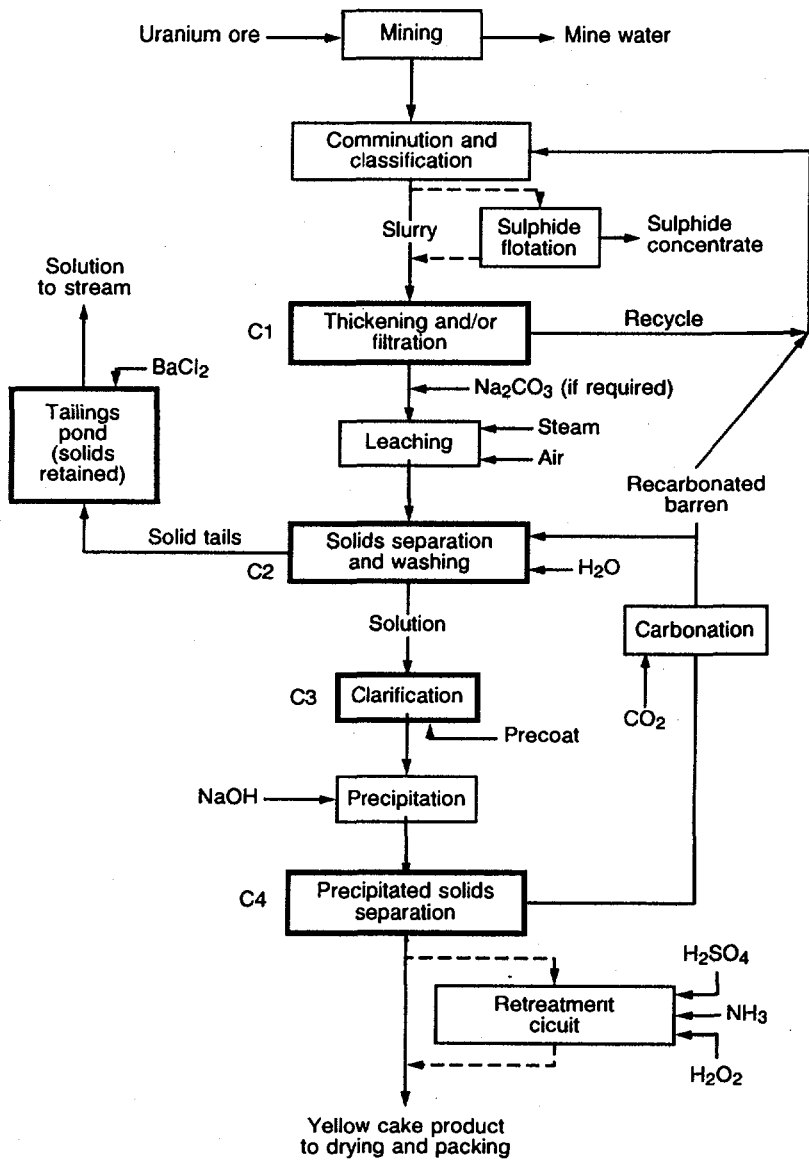

FIG. 6.4. Generic alkaline leach circuit.

the yellow cake product. These solids are removed by polishing or clarification (Fig. 6.4, stage C3).

Yellow cake is precipitated from the clarified solution using caustic soda. The precipitate is separated from the residual solution by settling followed by filtration or centrifuging (Fig. 6.4, stage C4).

If the yellow cake product does not meet the specifications, it may be necessary to dissolve it in acid and reprecipitate using ammonia or hydrogen peroxide precipitation techniques. This product must also be separated by filtration or centrifuging.

Solid-liquid separations used in the tailings management systems are discussed in Chapter 10.

### 6.3.2. Solid-liquid separation equipment

The uranium industry has used various types of thickeners and filters. The following paragraphs present a general overview of this equipment.

#### 6.3.2.1. Thickeners

As previously mentioned, both conventional and high rate thickeners have been widely used in uranium milling operations. The high rate thickeners were first introduced in the early 1970s, and most of the mills constructed or modified since 1975 have used these units in at least some component of their flow sheets.

(a) *Conventional thickeners.* The conventional thickeners used in the uranium industry have generally been either of the bridge type or centre pier type construction. Bridge type thickeners use a beam or truss structure across the diameter of the tank to support the drive mechanism and rake arms. This bridge also serves as a walkway and supports feed launders and piping. Bridge type thickeners are usually constructed in diameters up to about 100 ft (30.5 m). Above this diameter the bridge structure becomes too costly. The rake arms, which are driven from a central shaft, scrape the settled solids to a central discharge cone. Underflow piping is simplest with this design.

The centre pier design is primarily employed for thickeners that exceed 100 ft (30.5 m) in diameter. The raking mechanism is supported from a stationary concrete or steel centre column. The rake arms are attached to a driving cage that rotates around the centre column. A circular trough around the base of the pier collects the underflow for withdrawal.

Diagrams and additional information on both of these thickener types can be found in Refs [6.6, 6.13, 6.18].

(b) *High rate thickeners.* Figure 6.5 illustrates the construction of a typical high rate thickener. These units were first introduced into uranium milling operations



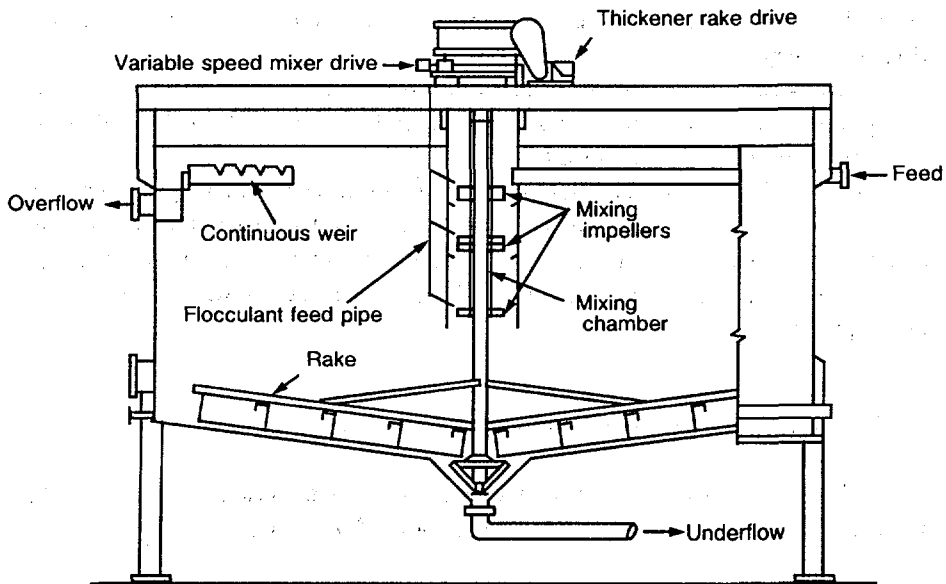

FIG. 6.5. Typical high rate thickener.

in the early 1970s, and most mills constructed since that time have used these units in at least some part of the flow sheet.

The thickener mechanism is supported by a truss structure, but the feed well is longer and of smaller diameter, and contains a special flocculation chamber. This chamber is fitted with a series of two or three mixing impellers. Flocculant is added at each impeller, and the flocculated slurry flows directly into the thickened pulp zone. Radially mounted inclined plates, which are partially submerged in the slurry, can produce faster and more effective thickening than that produced by a vertical descent. As discussed in Section 6.2.1.2, the unit areas for high rate thickeners normally range from one quarter to one tenth of that required for conventional thickeners. The height of the slurry blanket is automated through the use of level sensors. Automation and control are particularly critical because the relatively short retention in high rate thickeners necessitates a much closer control than that required for conventional thickeners.

One recent modification that has improved the high rate thickener performance is the installation of a deaeration tank ahead of the thickener. This unit is simply a small tank where the feed slurry enters below the surface so that air bubbles are eliminated. The deaerated slurry then feeds into the thickener feed well. This modification can eliminate excessive frothing and increase the clarity of the thickener overflow.

Many of the high rate thickeners used in the uranium industry have been units with diameters of 20 to 40 ft (6 to 12 m). Other mineral industry operations have used high rate thickeners with diameters of almost 130 ft (40 m). Conventional thickeners have also been converted to the high rate configuration.

Other high rate thickener designs use a bottom feed principle. This design and other information on high rate thickeners can be found in Refs [6.6, 6.10, 6.13, 6.14].

(c) *Instrumentation and control.* Instrumentation can assist greatly in maintaining the thickener performance, particularly in CCD circuits. For example, a decrease in underflow density of as little as 1% can significantly increase soluble losses.

Both diaphragm pumps and centrifugal pumps have been used to control the underflow densities. Diaphragm pumps have been most effective on underflow pulps with relatively low 'sanding out' characteristics. During the 1950s the uranium industry pioneered the use of underflow pumping systems that used variable speed centrifugal pumps controlled by radiometric density gauges.

Automatic controls on conventional thickeners have limitations due to the lag in response time caused by long retention times for both solids and liquids. The situation for high rate thickeners is the opposite.

Instrumentation has also included feed rate measurements, torque indicators, pulp height indicators and turbidity measurements on the overflows. Additional information about instrumentation and controls can be found in Ref [6.6].

#### 6.3.2.2. *Filters*

As with most hydrometallurgical operations, uranium mills have used many different types of filters in their operations. The following paragraphs discuss some of the most commonly used equipment.

(a) *Drum and disc filters.* Drum filters have been used for filtering and washing leach residues in most alkaline leaching mills. They have also been used in acid leach circuits, in particular for dewatering the underflow from the final thickener of a CCD circuit or for interstage solid-liquid separations in two-stage leaching circuits. This type of filter consists of a cylindrical drum that rests on bearings and is partially submerged in a tank containing the feed pulp. The degree of submergence normally ranges between 25 and 50%. These filters are often classified by their method of cake discharge (e.g. scraper discharge, string discharge, roller discharge). Most drum filters used in the uranium industry have been various modifications of the scraper discharge type.

Disc filters consist of pie shaped sectors that are fitted onto a central trunion to form a disc assembly containing from 8 to 30 sectors. The number of sectors in each assembly depends on the diameter of the filter. A single filter may contain as

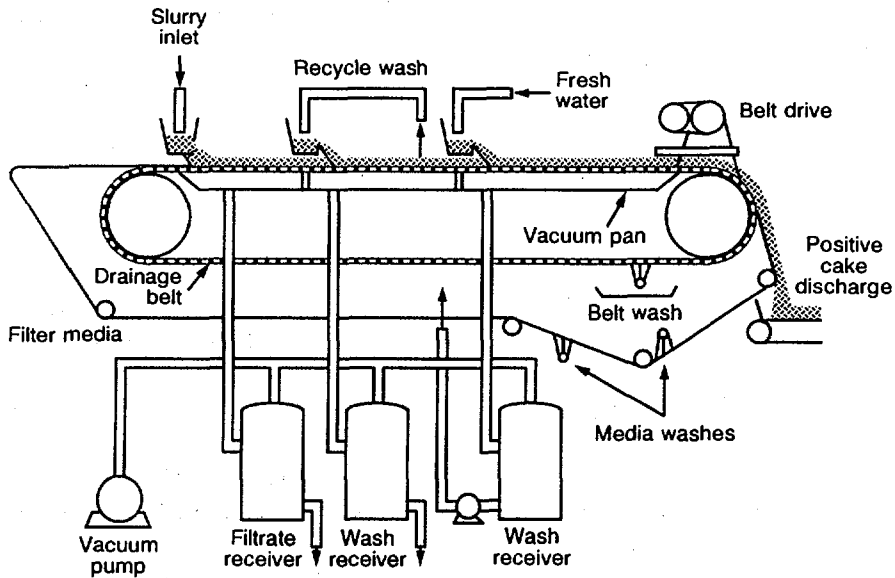

Fig. 6.6. Horizontal belt filter configuration.

many as 15 of these disc assemblies. Disc filters cost less per unit area than other continuous filters, and they also require the least floor space. Their principal disadvantage is that effective cake washing is not possible.

Details about both the mechanical characteristics and the operational criteria for drum and disc filters can be found in Refs [6.6, 6.13, 6.14, 6.18].

(b) *Horizontal belt filters.* During the 1950s and much of the 1960s, filtration after leaching was carried out primarily with drum or disc filters. Because of a poor washing efficiency, two or three stage filtration with intermediate repulping was necessary. During the late 1960s belt filtration received increasing acceptance in Europe, in particular in France. In the early to mid-1970s belt filters were also installed in South African and North American uranium mills. Horizontal belt filters have two main advantages over drum or disc filters:

- (a) A much better washing efficiency,
- (b) The ability to handle coarser pulps.

They are now used worldwide for both the filtration and washing of leached pulps and for yellow cake filtration.

(i) *Mechanics of the belt filter.* Figure 6.6 shows a diagrammatic sketch of a typical belt filter. The heart of the unit is a rubber or elastomer drainage belt that

slides over a vacuum box located under the centre of the belt. Both the drainage belt and the filter cloth, which is carried on top of the drainage belt, are driven by a large diameter rubber covered head pulley. Filtrate drainage is provided by cross groves in the drainage belt. These groves connect with drainage holes that pass over a slot in the vacuum box located under the centre of the belt. Special fluorocarbon plastic provides a low friction seal between the drainage belt and the vacuum box. Friction is further reduced by injecting water or clear filtrate into the sliding areas. Some large filters have used special narrow sacrificial belts that ride between the expensive drainage belt and the vacuum box.

Countercurrent washing can be achieved by dividing the vacuum box into sections with vertical baffles. The filtrate from each section is collected in a separate receiver tank. Dams (elastomer flaps or rollers that ride on the surface of the cake) are also positioned above the vertical baffles to divide the surface of the filter cake into cake formation and washing zones.

The endless filter cloth separates from the drainage belt and passes over a series of rollers. The cake discharges at the first roller. The cloth can be washed on one or both sides to prevent blinding. The cloth wash is collected separately and can be used for cake washing or dilution of the feed slurry. The cloth must be kept in alignment by automatic control systems.

The belt filter requires only one vacuum pump. Both pumps and barometric legs have been used to drain the filtrate receivers.

Belt filters with filter areas of  $120 \text{ m}^2$  have been used in South Africa. Reference [6.19] describes the characteristics of the various belt filters produced by the principal manufacturers.

(ii) *Mode of operation.* Feed boxes are designed to spread the feed uniformly across the belt. A number of the units operating in uranium mills have used feed boxes with fishtail shaped distributors. After the feed slurry is deposited on the belt, the cake forms gradually as the vacuum pulls the mother liquor through the filter cloth. As the drainage belt moves slowly forwards, the filter cake passes under the first dam and enters the first washing zone. Uranium operations normally use two or three washing zones. After the final wash the residual water in the cake is displaced by blowing air through the cake in the drying zone of the filter.

Some belt filter installations, such as that in the SIMO Bessines plant in France, have been automated by installing a system that controls the operation by measuring the vacuum level and the liquid depth in the washing pools.

Effective flocculation can significantly improve the performance of belt filters. This is one of the most critical operating variables. Flocculation with polyethylene oxide (PEO) has produced large increases in the filtration rate for some clayey ores. The method of introducing the flocculant into the pulp can be critical. Several minutes of retention in propeller agitated cells may be required.

Cake washability continues to be a complex and sometimes controversial question. Each pulp is different and no general rules or guidelines can be applied.

In some instances, such as in the COMINAK mill in Niger, the cake washing efficiency has been so poor that it was necessary to install two belt filters in series with intermediate repulping of the cake.

The desirable solids: liquid ratio for belt filter feed pulps is usually about 1:1. The moisture content of the washed discharge cake can vary from 25 to 35%. The wash water requirements can vary from 0.25 m<sup>3</sup>/t to 1.5 m<sup>3</sup>/t for dry solids. The pregnant liquor volume that goes on to ion exchange or solvent extraction usually varies between 1 to 2.5 m<sup>3</sup>/t for dry solids. Uranium recovery efficiencies can vary from 96 to 99%; the usual values are near 98%.

## REFERENCES

- [6.1] HESTER, K.D., "Liquid-solid separation", Lecture Notes, Short Course on Extractive Metallurgy of Uranium, University of Toronto, Toronto (1978).
- [6.2] COE, H.S., CLEVENGER, G.H., Methods for determining the capacities of slime-settling tanks, *Trans. Am. Inst. Min. Eng.* **55** (1916) 365.
- [6.3] INTERNATIONAL ATOMIC ENERGY AGENCY, Manual on Laboratory Testing for Uranium Ore Processing, Technical Reports Series No. 313, IAEA, Vienna (1990) 49-50.
- [6.4] KYNCH, G.J., A theory of sedimentation, *Trans. Faraday Soc.* **48** (1951) 166.
- [6.5] DAHLSTRÖM, D.A., Salt Lake City, UT, personal communication, 1990.
- [6.6] WEISS, N.L. (Ed.), SME Mineral Processing Handbook, American Institute of Mining, Metallurgical, and Petroleum Engineers, New York (1985) 13-26 to 13-29.
- [6.7] MERRITT, R.C., *The Extractive Metallurgy of Uranium*, Johnson Publishing Co., Boulder, CO (1971) 121-125.
- [6.8] COULSON, J.M., RICHARDSON, J.F., *Chemical Engineering*, Vol. 2, Pergamon Press, Oxford and New York (1968).
- [6.9] DAHLSTRÖM, D.A., Predicting performance of continuous filters, *Chem. Eng. Prog.* (Mar. 1978) 69-74.
- [6.10] KIRK, R.E., OTHMER, D.F. (Eds), *Encyclopedia of Chemical Technology*, 3rd edn, Vol. 10, Wiley, New York (1982) 289-293.
- [6.11] EIMCO CORPORATION, Leaf Testing Techniques — A Bulletin on Testing Procedures, EIMCO Corp., Salt Lake City, UT, USA.
- [6.12] IVES, K.J. (Ed.), *The Scientific Basis of Flocculation*, NATO Advanced Study Institutes Series, Series E: Applied Science, No. 27, Sijhoff and Noordhoff, Alpen aan den Rijn, Netherlands (1978) 369.
- [6.13] WILLS, B.A., *Mineral Processing Technology*, 4th edn, Pergamon Press, Oxford and New York (1988) 645-650.
- [6.14] MCKETTA, J.J., CUNNINGHAM, W.A. (Eds), *Encyclopedia of Chemical Processing and Design*, Vol. 22, Marcel Dekker, New York (1985) 190-192.
- [6.15] ROSENBAUM, J.B., CLEMMER, J.B., "Accelerated thickening and filtering of uranium leach pulps", *Peaceful Uses of Atomic Energy (Proc. Int. Conf. Geneva, 1955)*, United Nations, New York (1956).

- [6.16] BENEDEK, A., BANCI, J.J., Apparatus and Procedure for the Laboratory Evaluation of Polymeric Flocculants, Wastewater Research Group, Rep. No. 74-3185-1, Department of Chemical Engineering, McMaster University, Hamilton, Ontario (1974).
- [6.17] DANIELS, S.L., "Solids-liquid separation by coagulation and flocculation", Solids-Liquid Separation (TILLER, F.M., Ed.), Chemical Engineering Department, University of Houston, Houston, TX (1975) 135-169.
- [6.18] PERRY, R.H., CHILTON, C.H. (Eds), Chemical Engineers' Handbook, 5th edn, McGraw-Hill, New York (1973) 19-46.
- [6.19] BREWIS, T., Filtration, Min. Mag. (April 1991) 236-244.
- [6.20] LAFFORGUE, P., PEYRIERE, N., ROCHE, M., BRAUN, D.B., "The use of polyethylene oxide as a flocculating agent in uranium ore filtration", paper presented at AIME National Mtg, Dallas, TX, 1982.



## Chapter 7

### SOLUTION PURIFICATION

#### 7.1. INTRODUCTION

The purification of the clarified leaching solution can be accomplished by a number of methods depending upon the type of the solution. The variables include the concentration of the uranium, the amount and concentration of the impurities, and also the desired final purity of the uranium product. The leaching solution composition will essentially be dependent upon the mineralogy of the ore, and the leaching medium. Thus, a number of purification combinations may be applicable. For example, the alternatives can include the following, depending upon the feed solution analyses and grade of product demanded:

- (a) Direct precipitation from alkaline and some acid liquors;
- (b) Two stage precipitation;
- (c) Ion exchange, elution and precipitation;
- (d) Ion exchange, elution, precipitation or removal of impurities from the eluate and precipitation of the product;
- (e) Solution pretreatment for impurity (or by-products) removal, ion exchange, elution and precipitation;
- (f) Ion exchange, elution, solvent extraction, stripping and precipitation;
- (g) Solvent extraction, stripping and precipitation;
- (h) Solvent extraction, selective scrubbing or stripping to remove impurities or recover by-products, stripping of uranium and precipitation.

The various types of ore and possible processes are shown in Fig. 3.1. These diagrammatic processes indicate that for conventional acid leaching of low grade ores an ion exchange or solvent extraction process (or combination of these) could be considered. With low grade, complex ores containing elements such as nickel, cobalt and arsenic, solvent extraction separation and recovery of the uranium will probably be suitable. This approach also presents an opportunity for the recovery of by-products. A similar situation occurs with high grade, complex ores, except that a more aggressive leach, such as the use of Caro's acid ( $\text{H}_2\text{SO}_5$ ) or pressure leaching, should possibly be considered. The use of alkaline leaching, if there are high acid consuming minerals present, will result in a good dissolution of the uranium and very little solubilization of the gangue. Such a leaching solution may be treated by direct precipitation for the recovery of uranium. In the future, when chloride technology might be considered for environmental reasons, the uranium could be recovered by solvent extraction, the radium isolated by ion exchange and the by-products probably recovered by solvent extraction.



This chapter describes the application of ion exchange or solvent extraction technology for the recovery and purification of uranium and by-product metals from clarified solutions as well as from leaching slurries.

## 7.2. RESIN ION EXCHANGE

### 7.2.1. Introduction

In early 1949 researchers at the Rohm & Haas Company discovered that hexavalent uranium existed as an ionic complex in sulphuric acid leach liquors, and that quaternary ammonium anion exchange resins exhibited a high selectivity for this ionic species [7.1]. The first commercial application of this technology went on-stream in October 1952 at the West Rand Consolidated Mines, Ltd operation in South Africa. All of the first generation of uranium ion exchange operations used fixed bed systems. Uranium ion exchange technology has shown steady growth and innovation; the commercial acceptance of CIX systems for recovering uranium from unclarified leach solutions is the most recent technological development.

### 7.2.2. Ion exchange chemistry and resin characteristics

Commercial uranium ore leach liquors normally contain the following uranyl sulphate species:



Uranyl trisulphate predominates in most acidic leach solutions. The bisulphate complex is encountered when the value of the pH is close to two and the sulphate content is low.

The following uranyl carbonate anion species are normally found in alkaline leach liquors:



Both the sulphate and carbonate complexes are strongly sorbed by strong base and weak base resins. The predominant application of resin ion exchange has been in acid leach uranium mills; only a few of the conventional uranium mills have installed carbonate ion exchange systems. Carbonate ion exchange, however, has proven to be particularly applicable for recovering uranium from the dilute carbonate-bicarbonate product liquors produced by in situ leaching.

Ion exchange resins function both to concentrate and purify the uranyl anionic complexes. Ideally, a resin will absorb these complexes selectively from leach solu-

tions containing many other anionic complexes. Just as important, the resins should be able to do this rapidly and also reversibly so that the uranium can be recovered by elution. The loading capacity and kinetics are important because they determine the volume of resin necessary to produce a given amount of product. Not only does the resin selectively influence the uranium loading capacity, but it also controls the yellow cake purity in most plants.

Details of the uranium ion exchange chemistry have been described by a number of authors [7.1-7.6].

Most uranium ion exchange operations have used gel-type resins. This means that the polymer matrix of the resin is a continuous phase, and is essentially uniform throughout the beads. Gel-type resins are prepared by a three step procedure:

- (1) The liquid monomers, styrene and divinylbenzene, are charged into a copolymer reactor containing water. The monomers, which are insoluble in water, are then dispersed by mixing to form a suspension of oil-like droplets in the water. When the suspension is heated, the monomers polymerize into solid thermoset plastic spheres.
- (2) The styrene-divinylbenzene copolymer is then reacted with chloromethylether to produce an intermediate product.
- (3) The intermediate product is reacted with an amine to yield the final product. If trimethylamine is used, a strongly basic (quaternary ammonium) anion exchanger is formed. When dimethylamine is added, the final product is a weakly basic (tertiary amine) anionic resin. Most uranium ion exchange operations have used strong base resins. The weak base resins can produce a better iron rejection, but the uranium loading rates are slower.

Macroreticular resins are also commercially available. These materials have both a continuous gel phase and a continuous pore phase. The macroreticular bead structure is obtained by polymerizing the monomers in the presence of large amounts of non-polymerizable diluents. The open pore structure enhances the diffusional kinetics by shortening the diffusion path. The macroreticular resins generally have lower uranium loading capacities than the gel type resins. They also have lower true wet densities but better kinetics than gel type products. Silica fouling of the pores, however, has presented problems in some operations; the fouling can significantly reduce the loading rates.

The uranium loading obtained with a fresh resin normally decreases rapidly during the first few cycles of operation and then declines more slowly. This is partly due to:

- (i) Changes in the chemical structure of the resin
- (ii) The irreversible adsorption of some impurities from the feed solution.

The latter is called resin poisoning. Common resin poisons include molybdenum, polythionates, silica and sulphur. Titanium, zirconium, thorium and organic

TABLE 7.1. GEL TYPE STRONG BASE RESINS USED IN URANIUM MILLS

Trade name	Manufacturer
Amberlite IRA-400	Rohm & Haas Co., Philadelphia, PA, USA
Dowex 21-K	Dow Chemical Co., Midland, MI, USA
Duolite 101-D	Duolite International, SA, France
Ionac 641	Sybron Corporation, Birmingham, NJ, USA
Permutit SK	Permutit AG, Berlin, Germany
Type 717	People's Republic of China

materials can also poison resins. Various forms of caustic soda treatment have been used to remove the common resin poisons. Regeneration with strong sulphuric acid solutions (12N) has successfully regenerated resins fouled with titanium, zirconium, thorium and organic materials [7.3, 7.5].

The resin loading and elution characteristics as well as the poisoning effects can be studied in bench scale laboratory columns. Descriptions of the equipment and procedures are presented in Ref. [7.7].

Resins that have been used in uranium mills include the gel type strong base resins listed in Table 7.1. Prudent selection of the best resin for a given operation requires careful experimental studies using leach solutions produced from the specific ores to be processed.

The resin life depends on many factors. Each operation can have its own specific characteristics, but the following factors are in general significant:

- (a) The chemical environment, which can influence resin poisoning, oxidation, swelling, etc.;
- (b) The physical environment, which is determined by factors such as the type of contacting equipment and resin handling techniques;
- (c) The resin composition and characteristics that are determined by the manufacturing process and the raw materials used.

Laboratory tests can be valuable for determining the potential effects of the chemical environment and, when combined with industrial operating experience, can help predict attrition losses. Even with careful testing, however, unexpected resin losses have been encountered, in particular during startup operations.

Resin replacement or make-up requirements have varied widely. In some operations the effective resin life has exceeded eight years, while others have required complete resin replacement in less than two years. Resin losses due to attrition are particularly dependent upon the type of contacting system used. Typical attrition losses for the various systems are discussed in the following sections.

### 7.2.3. Ion exchange systems

The uranium industry has been a leader in the development of ion exchange technology. A wide variety of both batch and continuous systems has been investigated, and many patents have been granted. Batch systems that have been used include both conventional fixed bed operations and so called moving bed systems in which the loaded resin bed is moved to a second column for elution. A number of continuous systems and several types of resin-in-pulp units have also been installed in uranium mills throughout the world.

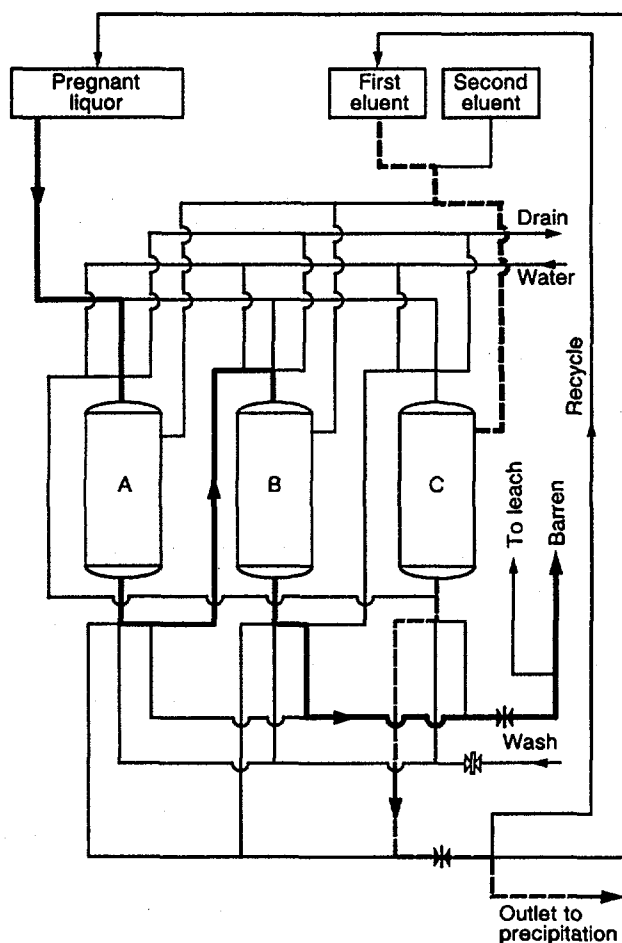

FIG. 7.1. Three column set for uranium extraction.

### 7.2.3.1. Fixed bed systems [7.8]

Fixed bed systems, similar to those used for treating the water in boilers, were installed in the South African operations during the early 1950s. These systems were comprised of three columns that were piped and valved in such a manner as to enable any two columns to be operated in a series on sorption while the third is being eluted [7.9]. This arrangement, which has been referred to as the 'merry-go-round' system, is shown diagrammatically in Fig. 7.1. Similar systems have been installed in the USA, Australia and in other countries; in Canada alone, over 50 such three-column sets were installed during the late 1950s. These were designed to treat clarified acid leach liquors containing 0.6 to 1.0 g  $U_3O_8/L$ , some of which are still in operation. The elution process is carried out automatically employing electromechanical equipment comprising timers and volumetric counters. Resin attrition losses in fixed bed systems have typically been less than 5% per year.

### 7.2.3.2. Moving bed systems

Following upon the design of the fixed bed units already described in which the elution of the resin is carried out in the same column as the sorption, another approach was made to increase the efficiency of the operation. This is known as the Porter-Arden moving bed system; it has been used at the Denison Mines in Elliot Lake, Canada, the Lucky Mac operation in the USA and other locations.

The principal departures of this system from the usual fixed bed approach are:

- (a) Three columns are used in series sorption allowing for higher specific flow rates to be employed.
- (b) A three column series elution system is also used, resulting in lower eluant consumption and shorter elution cycles.
- (c) A separate column is installed for backwashing the resin and acting as a holding tank between resin transfers from the sorption sets to the elution set.

The overall system is comprised of two sets of three sorption columns linked to one backwash column and one set of three elution columns. Figure 7.2 illustrates the arrangement of columns, which is piped and valved using the 'merry-go-round' concept.

When the resin in the leading sorption column is saturated, it is transferred to the backwash column. The empty sorption column is then immediately filled with eluted resin from the leading column of the elution set; it then becomes the third or trailing column on sorption. This type of system enables the ion exchange zone to extend over two sorption columns thereby allowing the columns to be operated at higher linear velocities of liquid flow.

After the loaded resin is backwashed, it is transferred to the empty elution column, which then becomes the trailing column on elution. This enables the volume

of eluant to be applied in three equal amounts instead of two (as practised with fixed bed columns employing recycled eluant). This procedure increases the strength of the eluate and also enables a column to become available for sorption in a shorter space of time.

The sorption and elution columns are almost full of resin as they do not require any freeboard for backwashing the resin. In addition, there are fewer controls required than are customary on fixed bed systems, where each set must have flow controllers for sorption, backwash and elution.

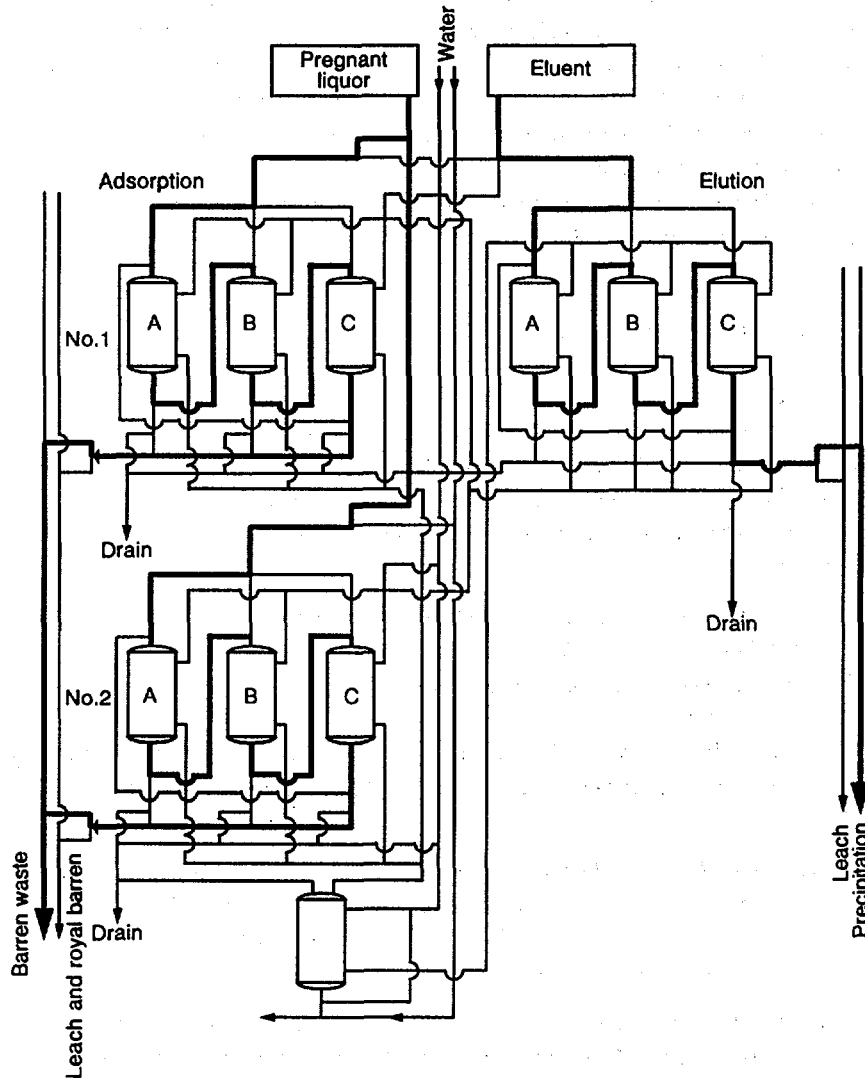

FIG. 7.2. Porter-Arden moving bed system.

Several of these resin movement plants were installed in Elliot Lake, Canada, in the late 1950s using 2.45 m diameter pressure vessels for containing the resin.

It takes about 20 min to transfer approximately 13 m<sup>3</sup> resin at a liquid flow rate of 22 m<sup>3</sup>/h. At the end of that time it has been found that about 30 to 60 L of resin remain at the bottom of the unit. This is of no consequence in the backwash and elution columns, but it is most undesirable in the case of the sorption columns. The loaded resin left behind is immediately covered with eluted resin from the elution set, and the column is placed in the trailing position on sorption. The royal barren effect so produced necessitates recycling back to the leach a large percentage of the barren. The recycling of 20 to 25% was not uncommon, but even so the average barren effluent to the tailings was often in excess of 0.005 g U<sub>3</sub>O<sub>8</sub>/L as compared with less than 0.001 g U<sub>3</sub>O<sub>8</sub>/L from fixed bed systems in the same area.

These systems were automated so that all the resin transfers and elutions were conducted automatically. A detailed description has been presented in an article by the Denison Mill staff [7.10].

The resin make-up requirements arising from attrition in moving bed systems have typically been around 10% per annum.

#### 7.2.3.3. Continuous ion exchange

A wide variety of continuous ion exchange systems have been investigated, and many patents have been granted. The early US installations have been described by Merritt [7.3] and a 1986 summary paper by Himsley [7.8] which contain supplementary information together with an extensive list of references.

Major technological contributions since 1978 include the following developments:

- (1) The commercialization of fluidized bed ion exchange columns in Canada, South Africa and the USA;
  - (2) The installation of a large multiple tank fluidized bed system at the Rossing Mill in Namibia;
  - (3) The installation of a pulsed bed down flow ion exchange system for recovering uranium from copper dump leach liquors at the Bingham Canyon operation in Utah.
- (a) *Fluidized bed ion exchange systems.* Several fluidized bed ion exchange columns have been developed; these systems are often designated in the current literature as CIX units. The following column systems have been installed in commercial uranium processing operations:
- (i) *NIMCIX contactor.* This contactor was developed by the National Institute for Metallurgy in South Africa. It was derived from the Cloete-Streat concept that was investigated initially during the early

1960s [7.11]. Columns up to 4 m in diameter have been installed in South Africa [7.12–7.14]. This system has been adopted with minor modifications by Davey Power-Gas.

- (ii) *USBM-MCIX column*. This system was developed by the US Bureau of Mines [7.15]; the column is an evolutionary development from the Winchester Column concept. Adaptations of the column by US uranium companies have been used in several in situ mining operations [7.16–7.18]. Columns up to approximately 8 ft in diameter have been fabricated from glass fibre reinforced plastic.

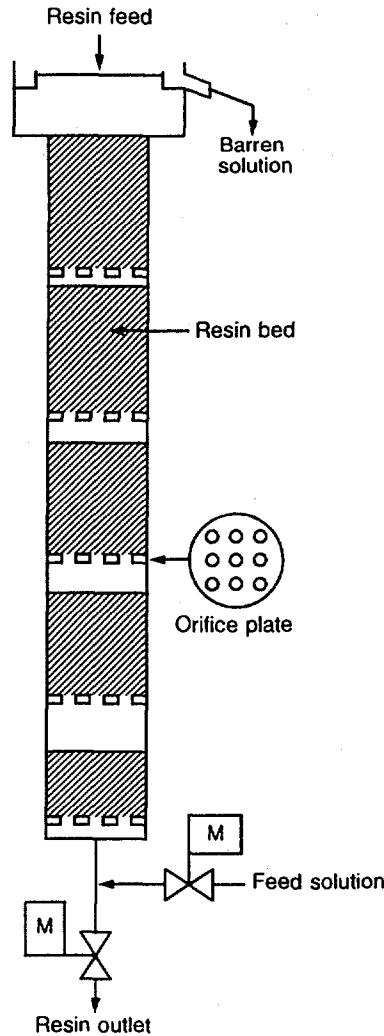

FIG. 7.3. CIX contactor fluidized bed ion exchange column (M, automatic control valve).



- (iii) *Himsley column*. This column, which was developed in Canada, is the most recent of the fluidized bed contactors. The column has been used in Canada, South Africa and the USA [7.19, 7.20]. It has also been used in a variety of waste water treatment applications.

Both the NIMCIX and USBM-MCIX column designs are based on the concept of a contactor in which the resin bed is fluidized by an upflowing stream of feed solution. A simplified schematic diagram of the absorption or loading column used in the NIMCIX and USBM-MCIX system is shown in Fig. 7.3. Orifice plates divide the column into a series of compartments; the orifice openings constitute between 1 and 5% of the cross-sectional area of the column. The feed solutions flow upwards through the column at superficial velocities of about 5 to 20 gal·min<sup>-1</sup>·ft<sup>-2</sup> (12 to 48 m/h). This fluidizes the resin and produces a discrete resin bed in each compartment. The upward flow of solution through the orifices prevents the resin from dropping into a lower compartment. Periodically, the feed stream is momentarily interrupted, a discharge valve is opened, and an increment of resin is discharged. This operational cycle permits increments of resin to move down through the column countercurrent to the solution flow. A similar column arrangement can also be used for elution of the loaded resin. Figure 7.4 shows the arrangement of a typical two column loading and elution system. Both the NIMCIX and USBM-MCIX columns can handle unclarified solutions containing up to about 2% solids.

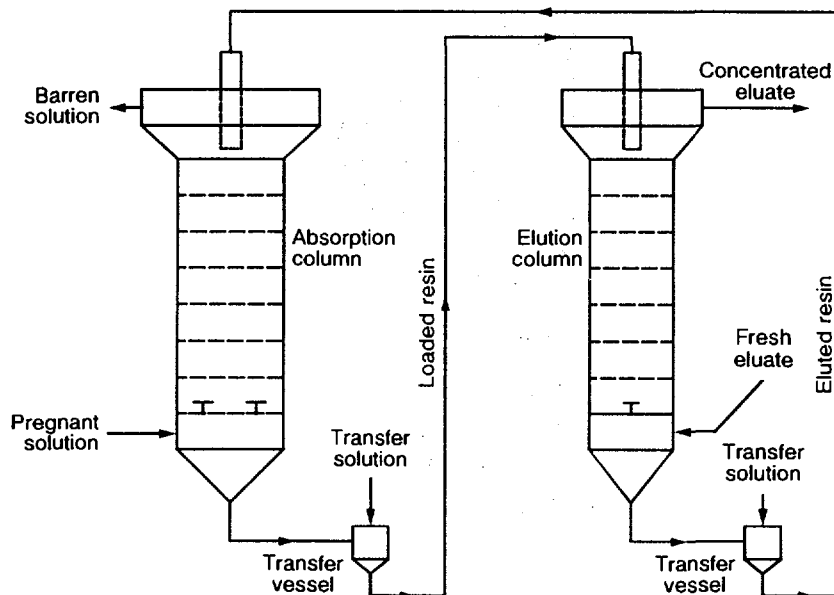

FIG. 7.4. CIX two column loading elution circuit.

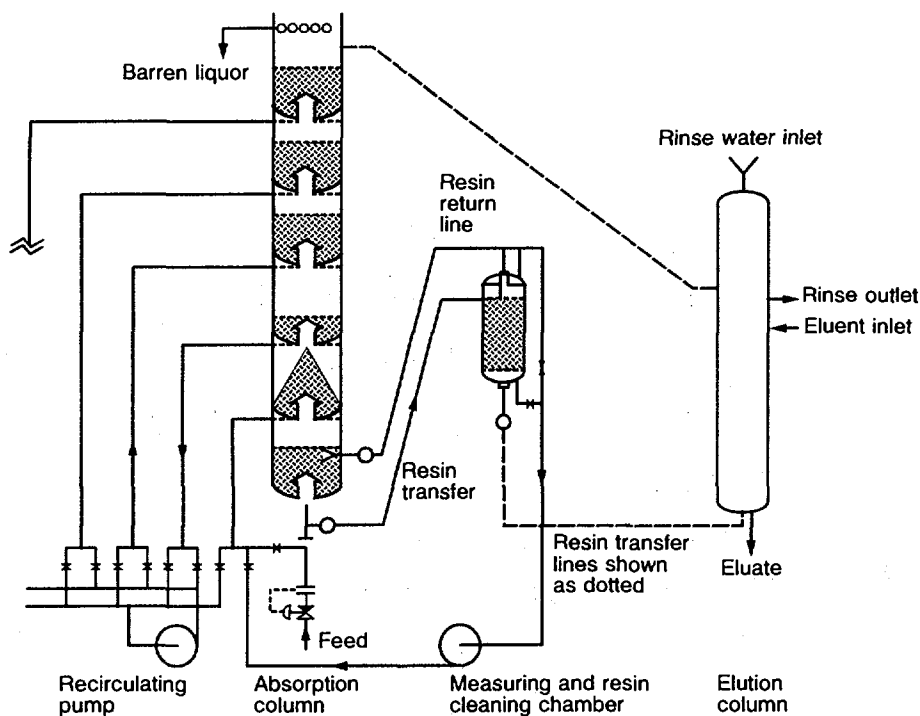

FIG. 7.5. Himsley CIX system.

Ford [7.21] and also Gritton and Jeffers [7.22] have developed mathematical modelling techniques for CIX columns.

The Himsley column [7.23] also uses a fluidized resin bed, but has an external piping arrangement that induces a flow of feed liquor to slurry resin between the sections without interrupting the feed solution flow. A diagram of the Himsley CIX system is shown in Fig. 7.5. In the system shown the adsorption is carried out in the fluidized multicompart ment column, each compartment having a single inverted weir flow distributor that is centrally located. The elution column is a multistage moving packed bed design employing downflow elution [7.25], designed to meet the specific needs of the Himsley system. Resin from the bottom stage of the fluidized bed loading column is transported as a slurry to a measuring chamber that is designed to measure a predetermined volume of resin and return any excess to the bottom stage. The measuring chamber is used to clean the resin with a backwash, and if necessary, scour with air. To minimize any dilution of the eluate, the measuring chamber is drained of feed solution and filled with eluate prior to transferring the resin into the

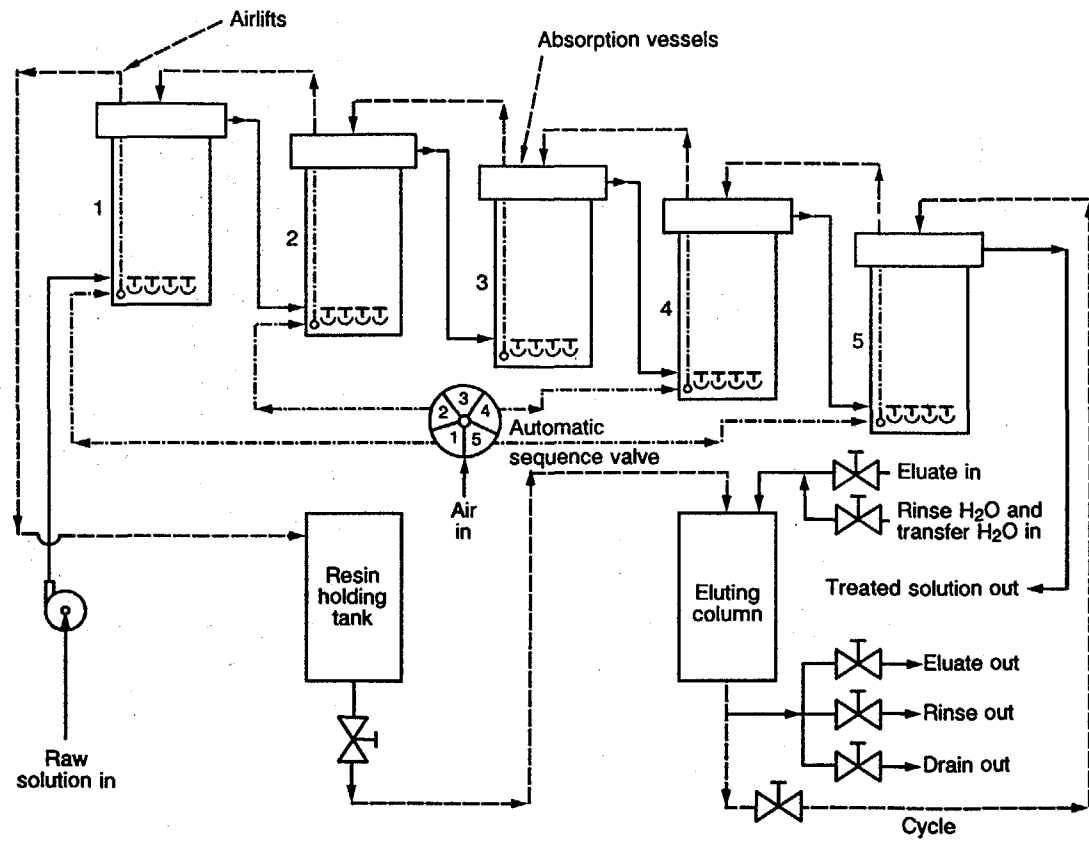

FIG. 7.6. Porter ion exchange system: full lines, solution flow; broken lines, resin flow; chain lines, air flow.

bottom of the elution column as a slurry. After the slurring liquor has been displaced from the bottom of the elution column, the uppermost batch of resin is transferred to the top of the adsorption column. The movement of the resin up through the elution column is essentially plug flow.

Eluate flows downwards through the resin bed in the period between resin transfers, and the uppermost batch of resin is washed with water, and in some cases, caustic scrubbed to remove silica prior to transfer to the adsorption column [7.25]. This countercurrent, multibatch series elution technique can produce high eluate strengths.

Resin losses due to attrition in the CIX systems have varied, but some have apparently been as low as 3% per annum.

(b) *Multiple tank, fluidized bed ion exchange systems.* A multiple tank, fluidized bed, ion exchange system has been developed by R.R. Porter. Adaptations of this system have been applied commercially in the Rossing operation [7.26-7.28], and by the US Steel Company in several in situ mining operations in Texas.

Countercurrent resin-solution contact is made in a series of individual adsorption vessels. A schematic diagram of the Porter system is shown in Fig. 7.6. The solution flows continuously from left to right through the series of five adsorption vessels; either gravity flow or pumping can be used. Periodically, the loaded resin in unit 1 is transferred by airlifts to the resin holding tank. The sequence valve then shifts and the resin in unit 2 is moved into unit 1. The cycle continues until the resin has been emptied from unit 5. Freshly eluted resin is then transferred into unit 5 from the elution system. Packed column down flow elution is used to recover uranium from the loaded resin. Since the feed solution continues to flow during resin transfer, some back mixing does occur, but apparently this produces only a minimal decrease in efficiency when relatively low grade feed solutions are used.

Available information indicates that all of the foregoing systems can handle slime slurries containing up to several per cent solids, but specific applications require individual experimental verification. The mineralogy of the slimes fraction can have a major influence on the operations. For example, the viscosity effects associated with clays may significantly reduce the maximum flow rates that can be used.

(c) *Pulsed bed down flow CIX (Chem-Seps systems).* The Chem-Seps, or as it is sometimes called the Higgins Loop CIX, system consists of a single closed loop in which various sections are separated by valves to isolate the functions that are being performed simultaneously in each of the sections. The movement of the resin and the solutions in this pulsed bed type of CIX system has been described by Higgins [7.29].

The resin is moved in small increments by the action of a hydraulic ram. All solution flows are countercurrents to the flow of resin, as shown in Fig. 7.7. The uranium is recovered in the process cycle, and the resin is moved in the pulse cycle.

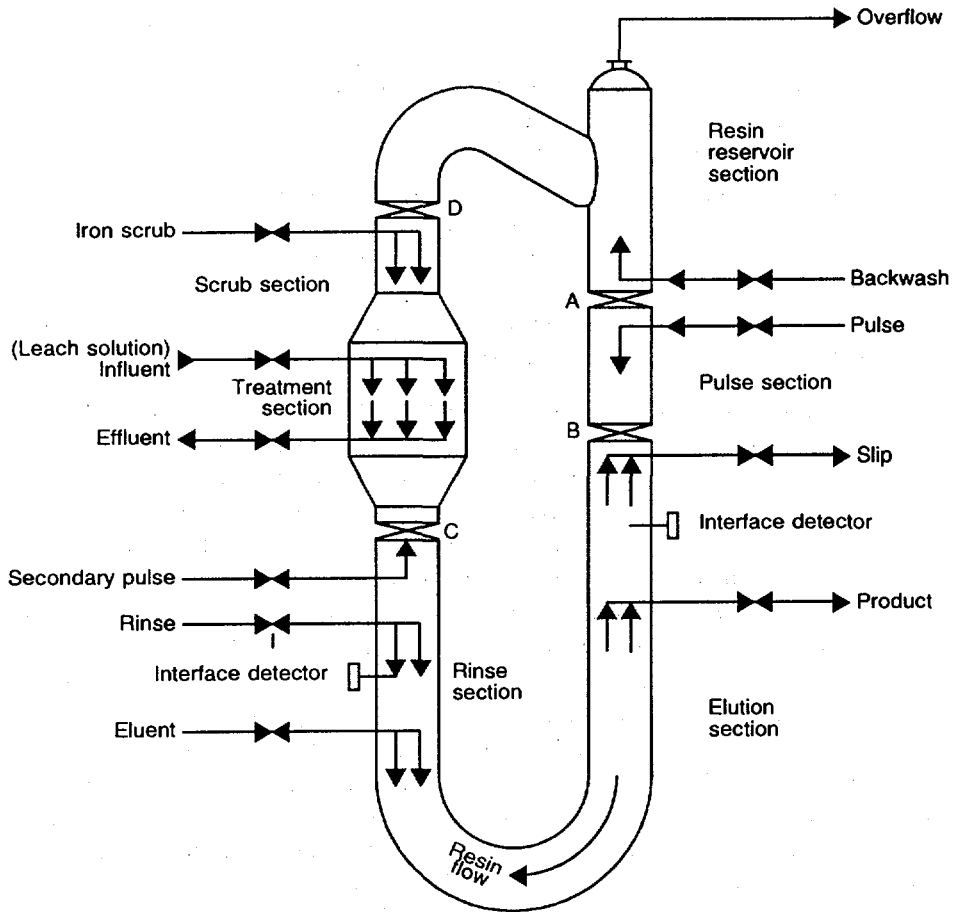

FIG. 7.7. Chem/Seps uranium recovery system.

In the process cycle, the influent enters through a set of distributors, moves downwards and leaves through a set of collectors. Simultaneously, the eluent enters through valve RE and leaves through valve WA. The rinse water enters through valve RI, and its duration is controlled by an interface controller.

In the process cycle, valves B, C and D are closed, isolating all the sections. The duration of the process cycle is dependent upon the uranium concentration and is controlled by a timer.

Valve A is open and resin is dropped into the pulse section simultaneously with the recovery of the uranium in the treatment section, elution and regeneration of loaded resin in the elution section, and rinsing of regenerated resin in the rinse sec-

tion. As the resin drops through valve A it is backwashed to remove the suspended solids or resin fines. Removal of these fine particles is important to avoid the unnecessary pressure drop in the bed and plugging of the distributors.

At the end of the process cycle all flows going into and out of the unit are automatically shut off. Valve A closes and valves B, C and D open in the correct sequence. A slug of water enters through valve PU, a predetermined incremental volume of resin moves into the elution section, an equal volume of regenerated and rinsed resin enters the bottom of the treatment section, and an equal volume of the loaded resin leaves the top of the treatment section and goes into the resin reservoir section. (The resin movement is of the plug flow type with the Reynolds number being in the laminar region of the curve, and no fluidization occurs during the pulse cycle.) The total time required for proper sequencing of valves and the movement of resin is 20 to 30 s. At the end of this period, valves B, C and D close, and valve A opens. The solution valves open and normal steady state operation begins. All valves are interlocked and operate in the correct sequence.

The specific operating flow rate is determined by the interaction of variables such as the pressure drop across the bed, the compressive strength of the resin beads, and the kinetics of the resin relative to the ion being exchanged. Superficial velocities of approximately  $60 \text{ gal} \cdot \text{min}^{-1} \cdot \text{ft}^{-2}$  (144 m/h) have been achieved in commercial practice.

The Chem-Seps system can handle feed solutions containing suspended solids because fine solids are removed from the top surface of the resin bed by backwashing during each pulse cycle. The amount of suspended solids that can be handled is dependent upon variables such as the uranium concentration in the feed solution and the desired loadings. In general, the amount of suspended solids that can be handled economically decreases as the uranium grade of the feed solution decreases. Since large volumes of low grade solutions are required to achieve satisfactory uranium loadings, the content of suspended solids must be lower to prevent plugging of the resin bed before the desired loading is achieved.

In 1976 the Wyoming Mineral Corporation installed four 2.4 m diameter Chem-Seps columns in their operations at Bingham Canyon, Utah. The columns are part of a circuit installed to recover uranium from copper dump leach liquors containing 6–8 ppm of  $\text{U}_3\text{O}_8$ . The circuit has been described by Brooke [7.30].

Resin losses approaching 70% per year have occurred in some pulsed bed down flow column operations. These losses were apparently due to the crushing action produced by high pressure drops when the throughput rates exceeded  $60 \text{ gal} \cdot \text{min}^{-1} \cdot \text{ft}^{-2}$ .

Himsley also designed a moving packed bed system, which is suitable for treating water that has a low concentration of suspended solids. Essentially this loading column operates in a similar manner to the elution column previously described. The first such commercial operation was installed in the USA in order to treat mine water to reduce the uranium content to less than 1 mg/L (1 ppm) [7.31].

Another moving bed column was developed by the Asahi Chemical Company of Japan [7.32]. This column has apparently not been used in uranium ore processing but has been adapted for water treatment applications in nuclear power plants.

The interest in CIX systems has continued to grow. One of the reasons for this interest is that the resin inventory in a continuous system is appreciably less than that required for a fixed bed ion exchange system. The continuous systems are also particularly suited to the handling of large volumes of feed solution with relatively high ionic concentrations. Several different types of commercial equipment are now available, and it is anticipated that these systems will find increasing use in both processing and waste management applications.

#### 7.2.3.4. *Resin-in-pulp*

The term resin-in-pulp (RIP) has been used to designate a class of ion exchange processes in which the leach pulp is classified to remove the sands, and the uranium is then recovered directly from the slimes slurry by resin ion exchange. The RIP process was developed primarily to:

- (1) Eliminate the capital and operating costs associated with the operation of the thickener or filter systems that are required to produce the clarified product solutions needed for solvent extraction or fixed bed ion exchange systems,
- (2) Minimize the loss of soluble uranium that occurs because of imperfect washing of the leached solids in thickener or filter CCD systems.

Several different commercial technologies have been used; these include the basket RIP systems and the continuous RIP systems, which will be discussed in the subsequent paragraphs.

(a) *Basket RIP ion exchange.* The basket RIP system was developed during the early 1950s and was first operated commercially in the USA in 1955. The resin is contained in baskets that are suspended in the desanded leach pulp. The basket RIP system was used in six US mills, but none are operating at the present time; either because the system has been replaced by technology that operates more economically or because the mill is no longer in operation.

The successful application of basket RIP units was the first step in a continuing sequence of new developments in RIP technology. The basket RIP literature remains noteworthy because it discusses criteria and limitations such as the following that must be considered for all RIP systems [7.33–7.35]:

- (1) The optimum ratio of pulp to wet settled resin required for effective uranium loading kinetics must be established. In the basket circuits this ratio was approximately 6 to 1.
- (2) The pulp residence time must be determined for each grade or type of pulp that will be processed. Basket circuits using six banks on loading required a total residence time of about 100 min.

- (3) The optimum feed pulp density may vary from ore to ore. Basket circuits required a density of 10% solids or less.

The make-up of the resin for the basket systems ranged from 15 to 20% per annum.

(b) *Continuous RIP ion exchange (screen-mix) systems.* Continuous RIP processes are those in which the leach pulp and the ion exchange resin beads move through the system in countercurrent flow. Nearly all of the present commercial continuous RIP systems use various combinations of the following operations:

- (i) The ion exchange resin beads are mixed into the desanded (-200 mesh) leach pulp, and the soluble uranium is absorbed by the beads.
- (ii) The loaded beads are separated from the pulp by screening.
- (iii) The uranium is eluted in a separate system, and the barren resin is recirculated to the loading operation.

In 1980 an overview paper by Simonsen et al. [7.36] stated that three mills in Wyoming produced uranium from sandstone ores for over 20 years using various RIP systems. Operating personnel in these mills concluded that the continuous RIP process offered substantial benefits in their situation. A fourth Wyoming mill used a continuous RIP section in parallel with an existing fixed bed ion exchange section of the moving bed type [7.37].

Simonsen, Boydell and James also indicated that solid-liquid separations represent between 15 and 35% of the capital cost of a conventional uranium plant and between 10 and 20% of the operating costs. In addition, there is a loss of soluble uranium that is discharged from the plant CCD circuit with the leached solids. Up to 3% of the soluble uranium may be lost. A RIP process can recover as much of the soluble uranium from a pulp as would be possible from a clear liquor; therefore the soluble loss arising from solid-liquid separation is eliminated. In some instances, when certain clays are present, the RIP recovery may be even higher. Some clays have a weak exchange capacity for uranium. The ion exchange resins have a stronger exchange capacity and therefore can in effect strip some of the uranium from the clays.

There are, however, practical problems encountered in the implementation of the continuous RIP process. The viscosity of leach pulps can be relatively high and may not be conducive to easy separation of the resin from the pulp. The abrasiveness of coarse particles in the pulp may cause attrition of the ion exchange resin beads and a consequent high rate of resin loss from the circuit. Moreover, the requirement of high efficiency in the extraction of soluble uranium necessitates some means of countercurrent contact of the ion exchange resin and pulp streams. Countercurrent contact, in these circumstances, is most readily effected by a multistage process with separation of the resin from the pulp between each stage, which detracts somewhat from the simplicity of the process.



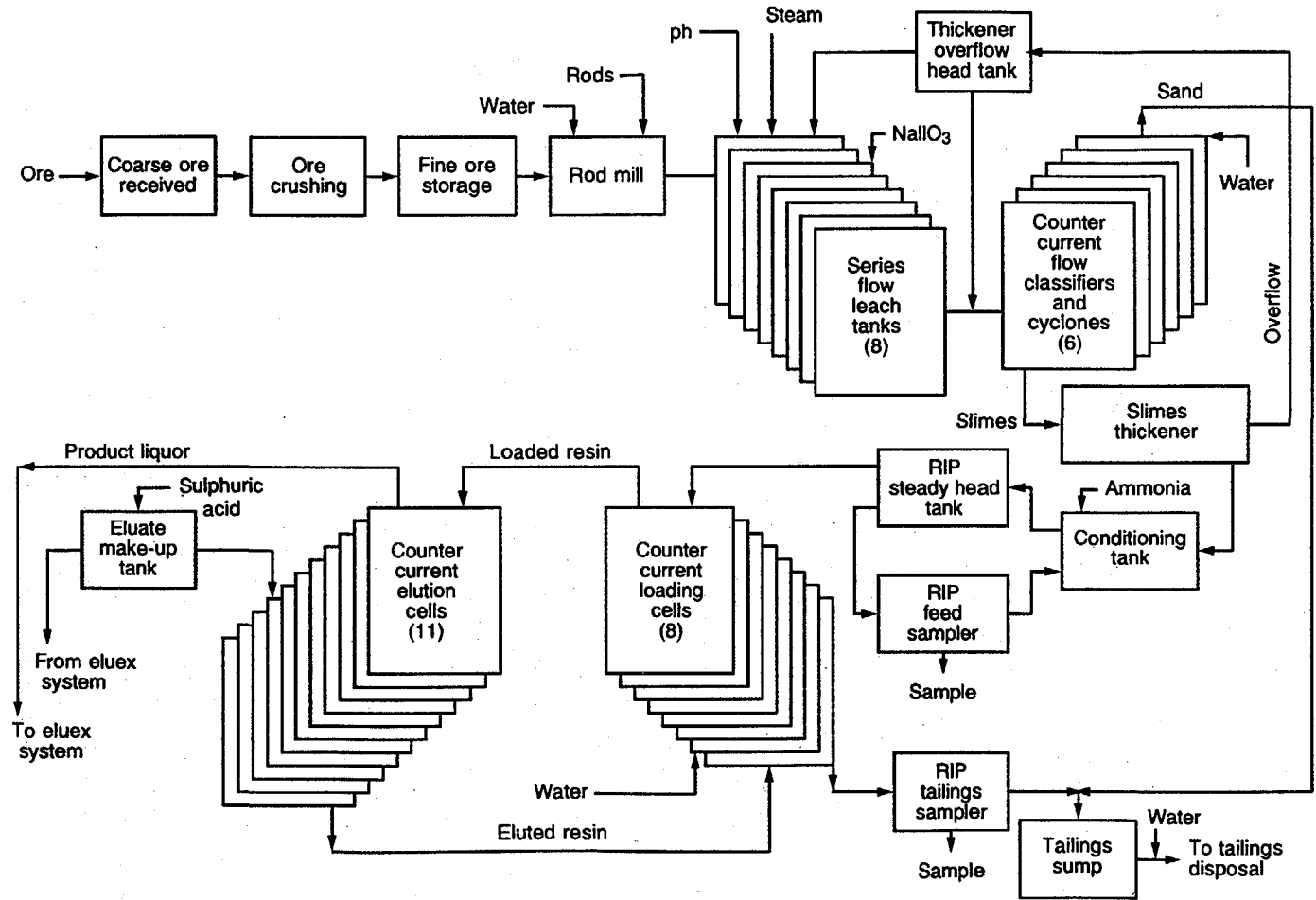

FIG. 7.8. Process flow diagram for Gas Hills plant.

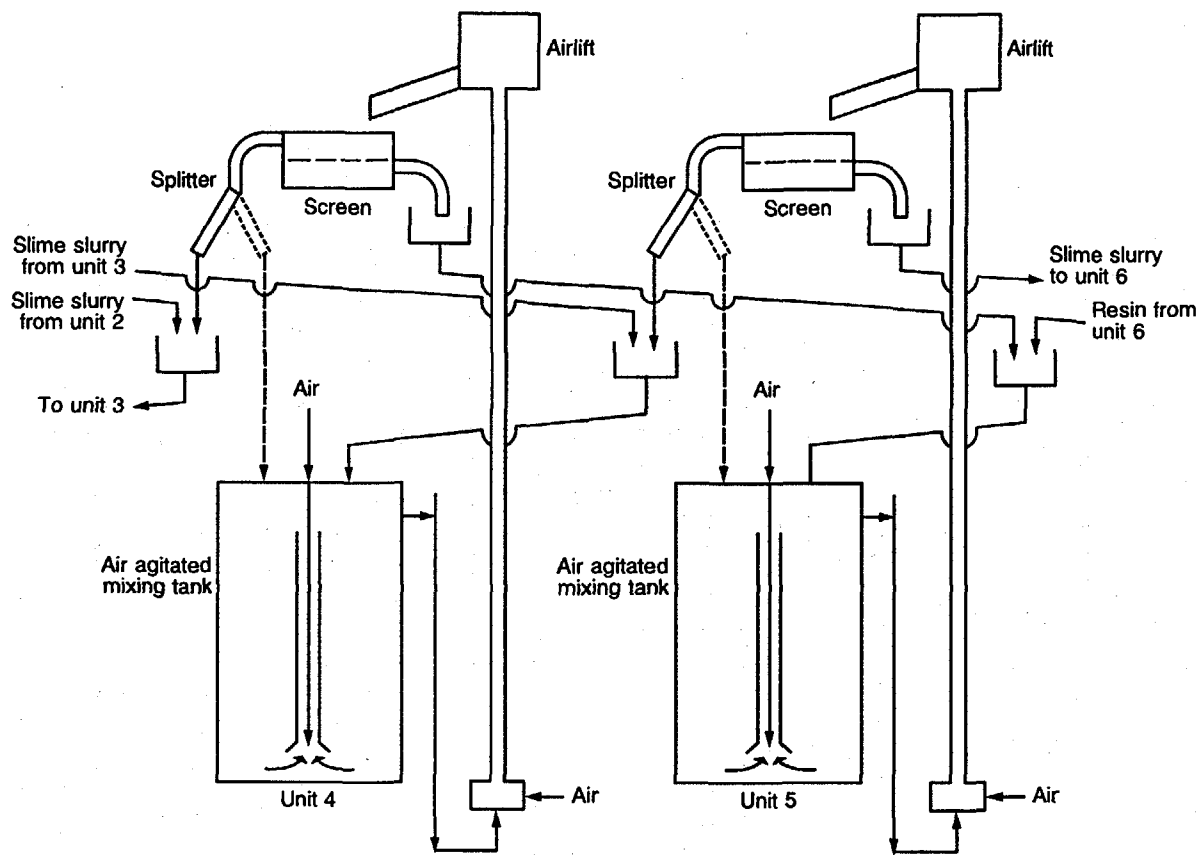

FIG. 7.9. Screen mix RIP system (two units shown).

Several Wyoming mills (Western Nuclear at Jeffrey City, and Pathfinder Mines and Federal American Partners in the Gas Hills district) ameliorated some of these problems by installing a sand-slime separation and washing circuit between the leach and RIP process. Cyclones in combination with either screens or spiral or drag classifiers produce two streams; a washed sandy product containing the coarse fraction of the solids and a pulp containing the fine particles, which make up the greater part of the feed. The pulp is diluted by the sand washings to a solids content of between 8 and 15%. This latter stream progresses to the RIP treatment stage. After the uranium has been extracted, this barren pulp is combined with the sand fraction and discharged to the tailings dam.

This process route is limited in its application to those ores that give rise to an easily separated sandy fraction after comminution. It has the disadvantage that relatively large quantities of liquid effluent, added to the circuit in the sand washing stage, are discharged with the tailings.

The Union Carbide mill at Gas Hills used a modified classification flow sheet, which incorporated a thickener that provided a dilution liquid for the initial classification stage. This system can produce slime slurries containing 20% or more of solids. Figure 7.8 illustrates the general flow sheet for the leaching, classification and RIP sections of this plant. Figure 7.9 shows two units of the screen mix RIP system used in this plant [7.38]. In this design resin and slime slurry move in opposite directions through a series of agitated tanks (or stages). The discharge from each mixing tank is screened; the slime slurry moving to a trailing tank and the resin to a preceding tank. The result is a continuous countercurrent flow of pulp and resin through the tank series to achieve resin loading and removal of uranium from the solution. A second series of tanks accomplishes elution with a similar countercurrent flow.

The resin and slime slurry were contacted in the air agitated mixing tank, which had a retention time of about 20 min. The mixture of resin and slime slurry overflowed and was lifted by a flow of air to a 0.21 mm (65 mesh) screen, which separated the resin from the slime slurry. The separated slime slurry flowed to the next unit on the right. The resin stream was split, part of it going to the next unit on the left and the remainder recirculated to the mixing unit. This resin recirculation permits adjustment of the resin:slurry ratio in the mixing tank to give optimum resin retention times. All splitters operated on the same time cycle to ensure a uniform movement of the resin.

Similar arrangements of equipment have also been used for the elution circuits, but the number of stages is normally 10 to 12. The larger number of stages permits the production of relatively high grade eluates containing 10 to 12 g  $U_3O_8/L$ .

Available information indicates that resin losses in the screen mix systems ranged from 20 to 30% per year.

Another type of screen-mix contactor, known as the Infilco-Technamix system, has also been described in the literature [7.39]. In the original design the load-

ing stages used air agitation, and each stage contained a built-in settling chamber for separation of the resin from the slurry. In actual practice the internal settling chamber separation design proved troublesome and was replaced by an external screen separation. The built-in settling chamber arrangement did prove applicable for elution circuit applications. An adaptation of this design was installed in the Trace Elements Corporation uranium mill at Maybell, Colorado.

A disadvantage, common to all ion exchange systems that require separate devices linked to each stage for the transport of liquid and resin, is the possibility of inventory imbalances developed within the circuit. For example, the resin concentration in the pulp in a mixing tank can be maintained at a steady value only by the exact matching of the flow rate of resin progressed to the stage plus the flow rate of resin recycled to that stage and the flow rate of resin leaving the stage, together with a similar balance on the slime flow rates. The difficulty of measuring resin concentrations in a pulp directly precludes the use of control in an automatic feedback loop. Manual control demands a measure of both experience and vigilance on the part of the operators.

Descriptions of the technology used in the former USSR [7.40, 7.41] indicate that a type of screen mix RIP technology, using stationary screens, has been used. Figure 7.10 illustrates one type of circuit that has been used for uranium recovery, and Fig. 7.11 shows column units that have been used in the former USSR. The unit pictured in Fig. 7.11 was developed during the early 1970s.

Gasos et al. [7.42] have described the screen-mix loading an elution column used at the Don Benito mill in Spain.

(c) *Suspended bed columns.* The Hengyang uranium mill in China has used an acid leaching RIP system with suspended bed columns since 1963. The plant has four parallel circuits. Each circuit, which consists of seven suspended bed columns, uses a 'merry-go-round' operating concept similar to that used in the basket type RIP circuits. Resin loading operates in an upflow fluidization mode; elution is carried out using a downflow packed bed procedure.

Figure 7.12 illustrates the basic design used for the suspended bed column. Each column is 4.5 m in diameter and 9.3 m in height. The carbon steel column shell is lined with stainless steel. At the bottom is a packed quartz sand bed, consisting of five layers of differently sized quartz sands. Its function is to retain the resin and provide a uniform solution distribution. A compressed air piping system is located on top of the quartz sand bed. When the resin bed is being backwashed, compressed air is introduced to expand the resin bed and disperse all the slime deposited on or in the resin bed. The pulp discharge device at the top of the column consists of a launder with screen sides made of stainless steel. The pulp passes freely through the screen, but the resin beads are retained. The resin bead diameter is 0.6–1.6 mm, and the screen aperture is 0.4 mm × 0.4 mm. Compressed air is bubbled upwards along



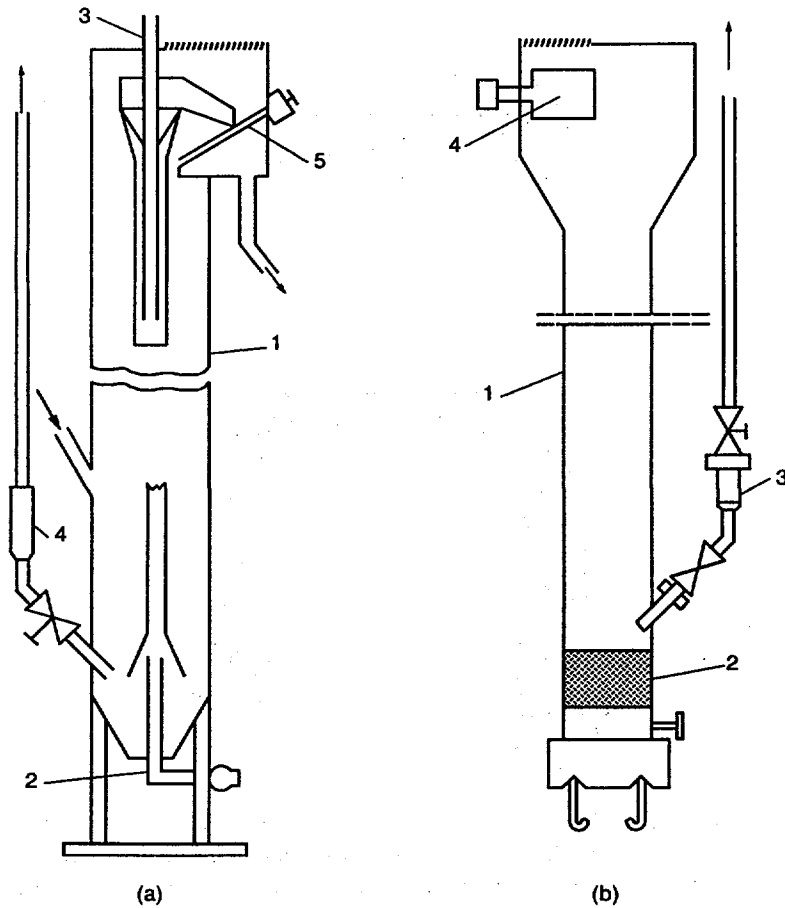

FIG. 7.11. System used in the former USSR for copper recovery; (a) Absorption unit: 1, body (3.0 m high and 0.3 m in diameter); 2, bottom airlift; 3, top airlift; 4, side airlift; 5, screen. (b) Elution unit: 1, body (1.8 m high and 0.2 m in diameter); 2, fitter body; 3, airlift; 4, screen.

the screen surface to prevent screen blinding by broken resin particles. Each column contains  $40 \text{ m}^3$  of strong base anion exchange resin.

Pulp is pumped into the column through the quartz sand bed, flows up through the column, and is drained via the upper discharge chute. In order to obtain a high adsorption efficiency, the resin beads must be uniformly suspended and dispersed throughout the lower and middle parts of the column. Factors that affect the resin suspension include the resin density, the pulp density, the pulp flow rate and the uniformity of the pulp flow.

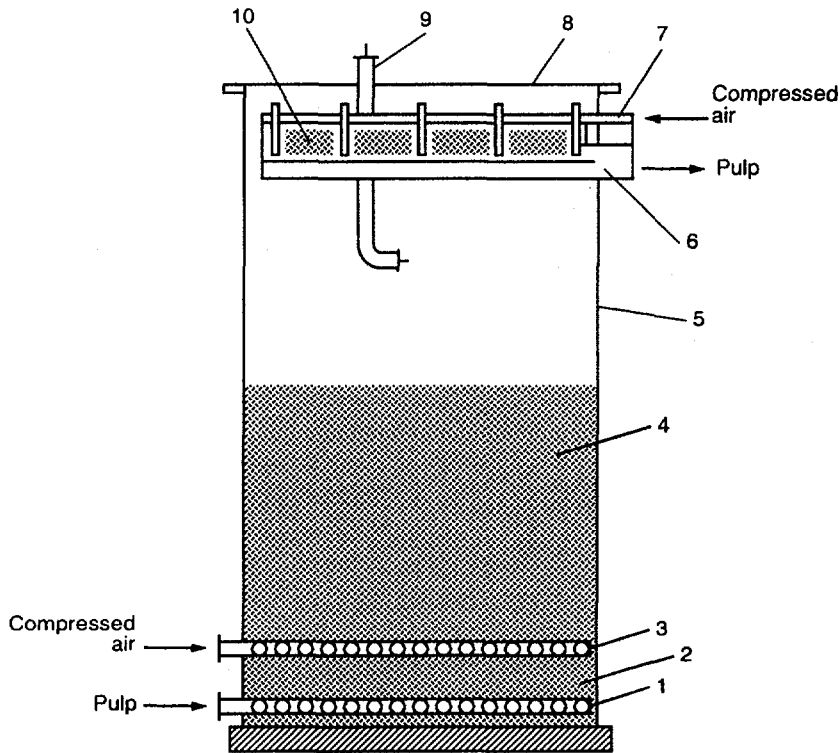

FIG. 7.12. *Suspended bed column: 1, piping for feeding pulp or discharging eluate; 2, quartz sand bed; 3, compressed air piping; 4, resin; 5, column vessel; 6, pulp discharge system; 7, screen cleaning system; 8, column top; 9, eluent inlet pipe; 10, pulp discharge system screen.*

In the Hengyang mill the pulp density ranges from 8 to 11%; its specific gravity is around 1.05. The resin density varies between 1.09 and 1.13. A superficial velocity of 8 to 10 m/h produces an optimum resin suspension. Further increases in pulp density or flow rate cause the resin to float to the top of the column and block the screens.

All coarse sand (i.e. +200 mesh) must be removed from the pulp before it is fed to the column. If the coarse sand is not removed it settles, partially blocks the quartz sand bed, and interferes with the pulp distribution. As a result, the efficiencies of both absorption and elution decrease dramatically.

Resin losses have been as low as 70 g of resin per tonne of ore treated. The system requires relatively large resin inventories but has proved applicable for treating ores from a variety of Chinese deposits.

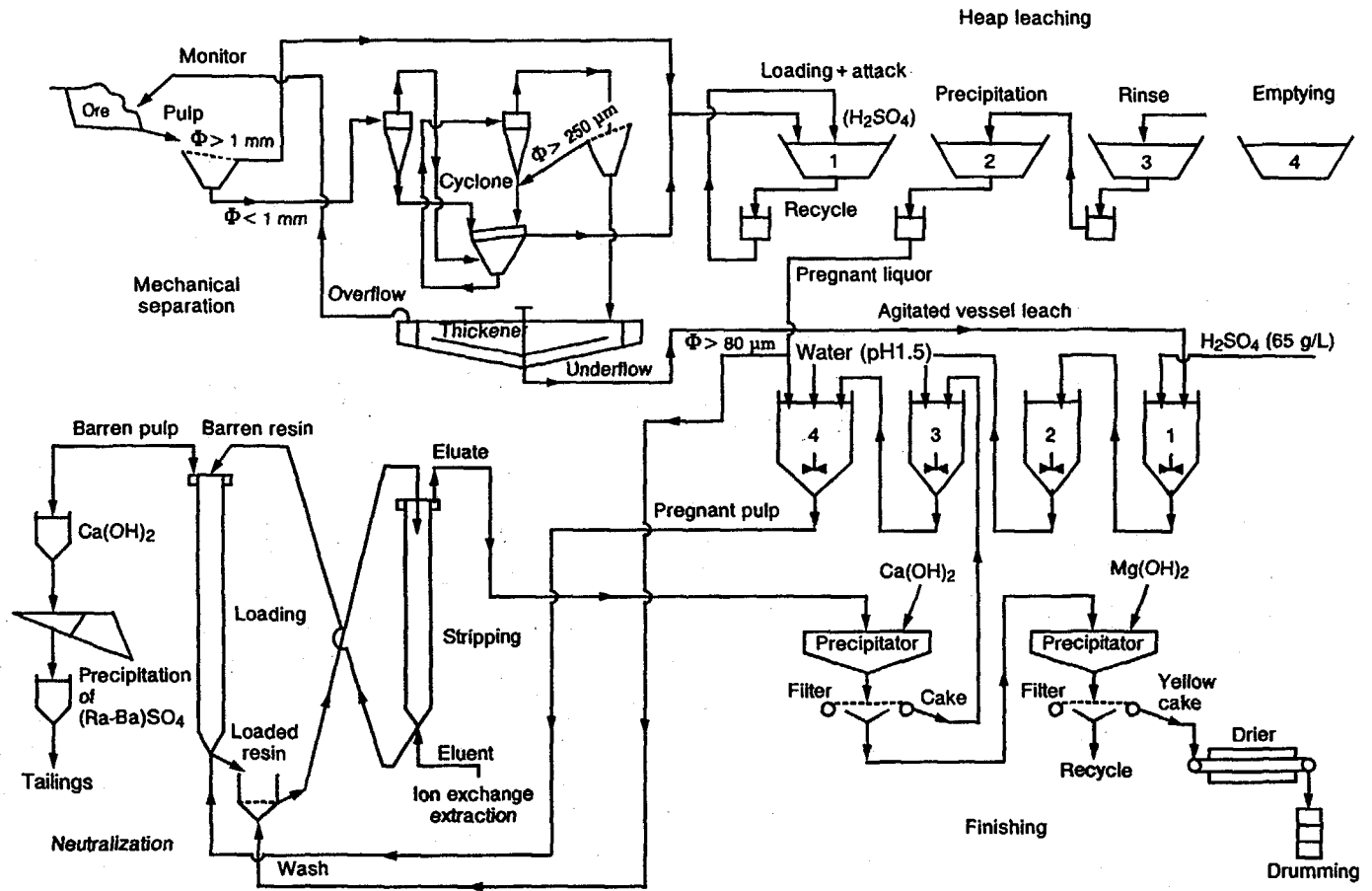

FIG. 7.13. Flow sheet of Scumra at St. Pierre-du-Cantal, France, with columnar RIP.



(d) *Continuous columnar RIP ion exchange.* A small mill operated by SCUMRA at St. Pierre-du-Cantal in France used a novel upflow column variation of the RIP approach which is illustrated in Fig. 7.13. This system has been described by both Mussard [7.43] and Simonsen et al. [7.36]. The ore is a heavily weathered granite containing quartz and chalcedony pebbles. A separation of the sand from the slime is carried out before the leaching stage using cyclones and screens. The bulk of the material is  $+80\ \mu\text{m}$  in size. This fraction is diverted to a dump leaching operation. The slime fraction containing around 40% of the uranium is thickened to 20% solids and subjected to a conventional acid leach. This leach pulp is then diluted to 5% solids by combination with the liquor flowing from the dump leach operation. The resulting thin slime is treated in an upflow continuous ion exchange contactor.

#### 7.2.3.5. *Comments on CIX*

The ability of upflow CIX contactors to handle a thin stream of pulp has been reported by Haines [7.13], Ritcey et al. [7.44], and Rosenbaum and Ross [7.45]. The limitations of this technique are well understood. The relative density of the pulp mixture must be less than that of the ion exchange resin beads to allow them to settle through the pulp. Conventional strong base ion exchange resins have a relative density of between 1.10 and 1.15, which limits the solids content in the pulp treated to less than 10%. A heavy resin of relative density in the sulphate form of 1.25 has been described by Arnold [7.46]. Development work is continuing on heavy resins, which could extend the potential application of upflow fluidized bed resin contactors to around 20% solids. As the solids content increases, the viscosity of the pulp becomes important. If the viscosity is too high then separation of the resin and pulp streams becomes impractical.

Large ion exchange resin beads separate from a pulp stream by gravity more readily than small ones. If other factors did not enter into the balance, RIP operators would choose to use resin beads the size of golf balls. However, there is an upper limit to the size of the beads that can be made by conventional manufacturing processes. Moreover, the rates of absorption and elution of uranium fall off rapidly as the size of the resin beads is increased, and large beads are more prone to fracture when subject to chemical cycles and physical stress than are smaller beads.

At the St. Pierre-du-Cantal mill, a  $+20$  mesh size fraction ( $+841\ \mu\text{m}$ ) of resin was used. The Wyoming plants used a finer grade of resin because of the restricted time available for elution, and the high degradation rates experienced with  $+20$  mesh resin.

#### 7.2.3.6. *Comments on RIP*

During the past 25 years various forms of the RIP system have been successfully used in a significant number of uranium mills throughout the world. References

in the literature indicate that RIP plants of various sizes have operated in China, France, the former USSR and the USA. The basket RIP system, which was developed during the 1950s, was the first to be used, but there are none of these in operation at the present time.

Currently, various modifications of the screen-mix system are the only RIP technology capable of handling medium or high density slurries. Desanded pulps containing up to around 20% solids have been successfully treated. The RIP systems eliminate both the capital and the operating cost expenses required for solid-liquid separation systems. Soluble uranium losses due to incomplete washing are also minimized. The RIP process can be particularly applicable for ores that pose difficult solid-liquid separation problems. Resin losses due to abrasion can be significant, but may be minimized by appropriate circuit design. The classification systems used to produce the desanded RIP feed pulps can increase the volume of waste water that must be handled and treated.

The development of competitive high density ion exchange resins (with a specific gravity of 1.25) could significantly extend the potential application of continuous RIP columns.

### 7.3. PURIFICATION BY SOLVENT EXTRACTION

#### 7.3.1. Introduction

The nuclear energy industry was the prime user of the solvent extraction technique for metals separation and recovery up to the time of base metals recovery in the late 1960s when the first large copper plants came into production. The growth of the uranium industry, where the solvent extraction method has been used, is shown in Fig. 7.14 [7.47]. The recovery of uranium from ores by using solvent extraction began in 1955 with the use of di-ethylhexyl phosphoric acid (DEHPA) (the DAPEX process), and since 1957 secondary or particularly the tertiary amines (the AMEX process) have been the most popular extractants. The tertiary amines are selective for uranium in the presence of impurities such as iron, thorium, phosphate and rare earths. Molybdenum as well as zirconium, if present, will also be extracted. The DAPEX process using DEHPA is not selective, and will also extract many other metals, such as iron, vanadium and rare earths.

The general solvent extraction flow sheet is shown schematically in Fig. 7.15. The metal bearing process solution is usually fed as a countercurrent to a flow of an organic solvent fed into a mixing device or contactor to mix the two phases. This contact, or extraction process, results in the transfer of the metal species from the aqueous phase into the organic phase. Generally, more than a single stage of contact will be required in order to obtain maximum recovery of the metal. Following mixing, the phases are allowed to separate or coalesce. The aqueous phase, or raffinate,

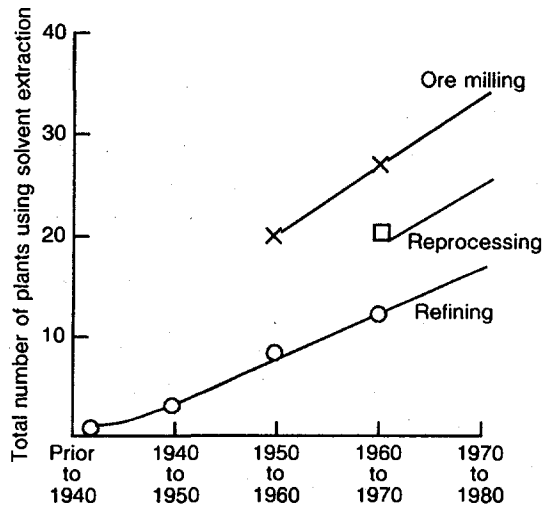

FIG. 7.14. Growth of uranium processing.

is separated from the organic phase and may be treated for the recovery of other values, recycled to some point upstream or downstream of the solvent extraction process, or discharged as waste.

Following extraction, the loaded solvent is usually contacted with a scrub solution to remove undesirable impurities from the solvent prior to recovery of the metal, in this case uranium. In uranium circuits the common impurities in the solvent, which are usually caused by absorption, will be the entrained leach feed liquor which will contain iron, silica, aluminium and other impurities. Removal of these, usually by washing in water, will result in minimum emulsion and crud formation as well as a better final uranium product.

After scrubbing, the solvent passes to the stripping circuit where the uranium is recovered in an aqueous solution by contact of the solvent with a suitable aqueous solution. Such solutions are discussed later. The resultant strip solution is treated in a precipitation circuit to produce a uranium 'yellow cake' product. This precipitation operation is discussed in Chapter 8.

The stripped solvent is returned to the extraction circuit. If necessary it may be treated (equilibrated) with sulphuric acid prior to extraction to obtain maximum stage efficiency.

Several contactors may be required in each of the extraction, scrubbing and stripping circuits depending upon the particular feed solution concentration and impurities present. In addition, different contactors may be used in each circuit to provide for optimum operation and economy, as well as to minimize the potential environmental impact of the process wastes.

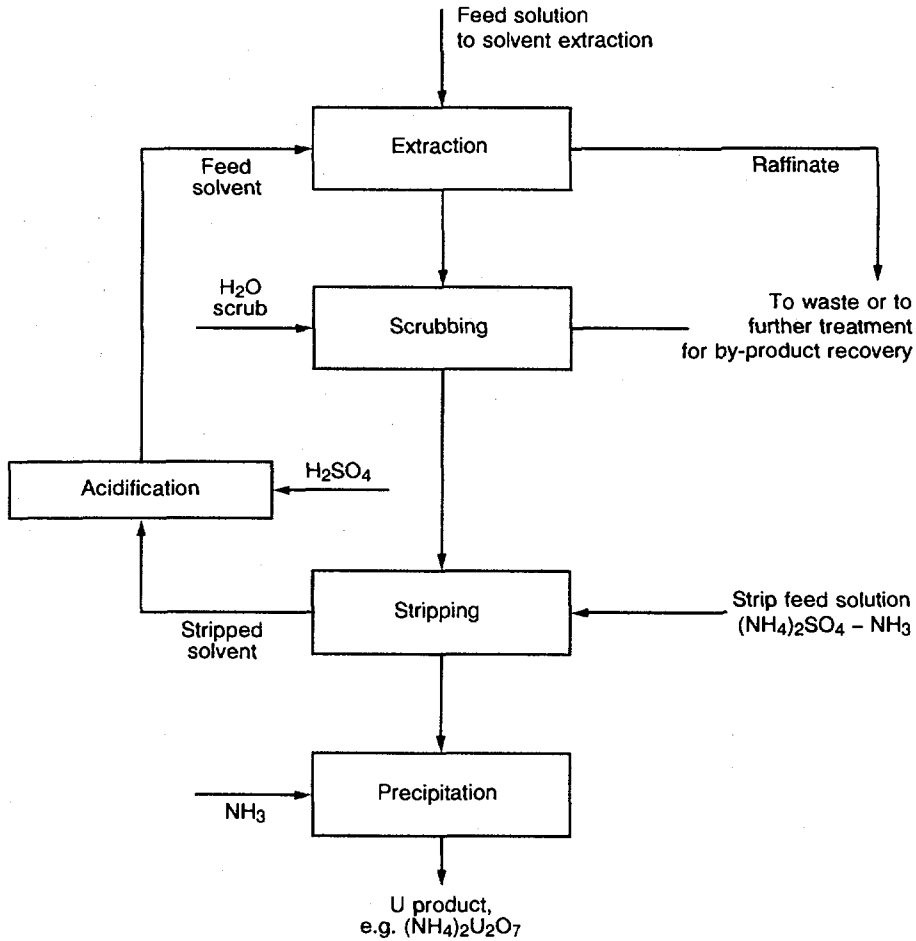

FIG. 7.15. Schematic flow sheet of purification by solvent extraction.

The most common lixiviant for uranium ores has been sulphuric acid, although at least one plant has used nitric acid with a tri-*n*-butyl phosphate (TBP) extraction [7.48], and a few plants have used alkaline leaching followed by direct precipitation of the yellow cake [7.49]. Several plants use a combination of ion exchange and solvent extraction in treating sulphuric acid leach solutions containing uranium. The possible use of chloride leaching has been thoroughly investigated [7.50, 7.51] and should be carefully considered for future uranium plants.

For the most part, mixer settlers have been the contactors used in the processing of uranium bearing liquors, with many modifications and designs having been presented since the early gravity mixer settlers. More recently there has been an interest in the possible application of differential column contactors, and now there are plants using a compact sieve plate pulse column design [7.52].

Control of the solvent extraction process has become more sophisticated because of the demand for process optimization in order to maximize the recovery, to increase the product purity, to minimize any adverse affects on the environment that the process might impose, to increase the potential for by-product recovery, to reduce the reagent costs and to reduce the overall operating costs.

This section on solvent extraction purification will deal with the sulphuric acid leaching process (although much would also pertain to a chloride leaching process). The reader should also refer to certain texts such as Clegg and Foley [7.53], which describes the industry up to 1958; Merritt [7.53] up to 1971; Ritcey and Ashbrook [7.54], which provides details about the subject of solvent extraction up to 1981; numerous proceedings of international agencies, such as the IAEA; the proceedings from several International Solvent Extraction Conferences held in Gatlinburg (1962) [7.55], Harwell (1965) [7.56], Göteborg (1966) [7.57], The Hague (1971) [7.58], Lyon (1974) [7.59], Toronto (1977) [7.60], Liège (1980) [7.61], Denver (1983) [7.62], Munich (1986) [7.63], Moscow (1988) [7.64] and Kyoto (1990) [7.65]. In addition, there are several general texts on the subject of solvent extraction, such as those by Schweitzer [7.66], Lo, Baird and Hanson [7.67], and Ritcey and Ashbrook [7.54].

### 7.3.2. Extractants

Although both the alkyl phosphoric acids and amines are possible extractants, the alkyl phosphoric acids never did become popular, mainly because of their non-discriminating nature compared with the relatively discriminating amines. Thus the tertiary amines continue to be the most widely used for treating process solutions resulting from sulphuric acid leaching of uranium bearing materials. As noted earlier, there is also the possibility of leaching ores in nitric acid, and therefore the neutral alkyl phosphate (TBP) can be used with success. These three classes of extractants for uranium are now discussed briefly.

#### 7.3.2.1. Acidic extractants

The extraction of metals as cations from acidic solutions is very much dependent on pH, and therefore the degree of extraction is somewhat parallel to the order of the hydrolysis constants. Because of this sensitivity to pH there must be close control of the acidity in order to reduce the amounts of metal contaminants that are also extracted. The common extractant in the so called DAPEX process has been di-2-ethylhexyl phosphoric acid, which is often abbreviated to DEHPA, EHPA or D2EHPA. Typical extraction curves for a number of metal cations are shown in Fig. 7.16 [7.54] as a function of pH,

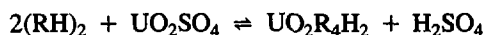

As noted above and earlier, control of the pH value is important in this system, and unwanted metals can be extracted and be a problem. One such co-extracted metal is iron. This contaminant not only occupies sites on the extractant, but is also extremely difficult to strip.

The degree of co-extraction can be minimized by maintaining the iron species in the reduced state of oxidation during the extraction stages. In addition, because the extraction of metals by DEHPA is usually very fast, the kinetic differences between uranium and iron, the latter being extracted very slowly, can enhance the discrimination and reject the iron. Recently, other alkyl phosphorus acid extractants have been produced that could offer possibilities in the extraction of uranium: these are phosphonic acid (Albright and Wilson) and the phosphinic acid (Cyanamid Chemicals). The effect of the concentration of DEHPA on the extraction is shown in Fig. 7.17 [7.54].

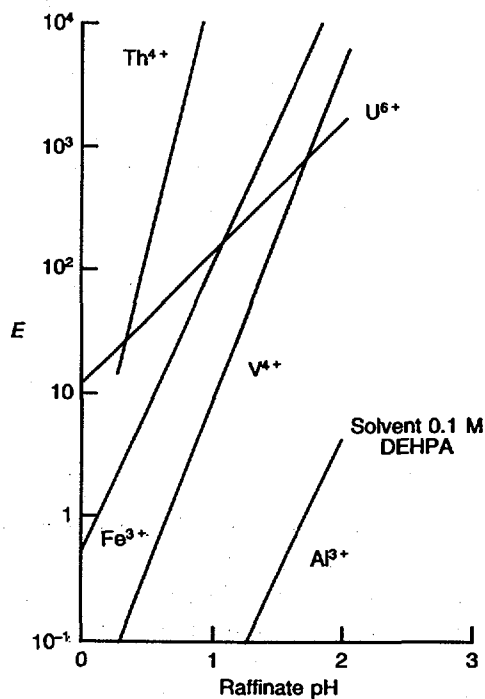

FIG. 7.16. Effect of aqueous pH on the extraction coefficient ( $E$ ) values for various metals.

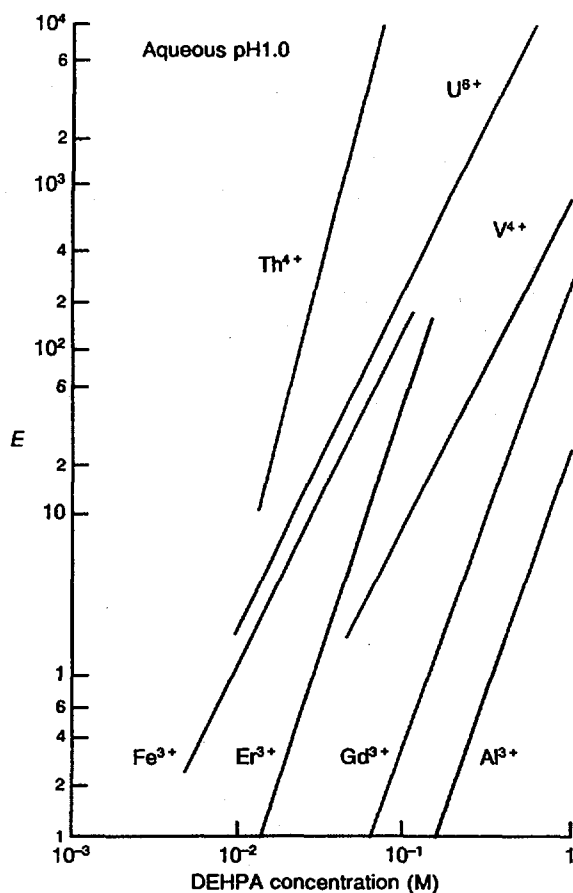

FIG. 7.17. Effect of DEHPA concentration on the extraction coefficient ( $E$ ) of various metals.

### 7.3.2.2. Basic extractants

Tertiary amines, such as Adogen 363 (Sherex Chemicals) or Alamine 336 (Henkel Chemicals) have been the most widely used anion extractants for the recovery of uranium from sulphuric acid leach liquors. While these extractants are relatively selective for uranium, there are nevertheless a few other metals that extract much more preferentially. In uranium circuits the major impurity that is extracted preferentially to uranium is molybdenum, as shown in Fig. 7.18 [7.54]. It can be removed by carbonate stripping after first selectively stripping the uranium with a chloride solution. Several plants have operated successfully with such a

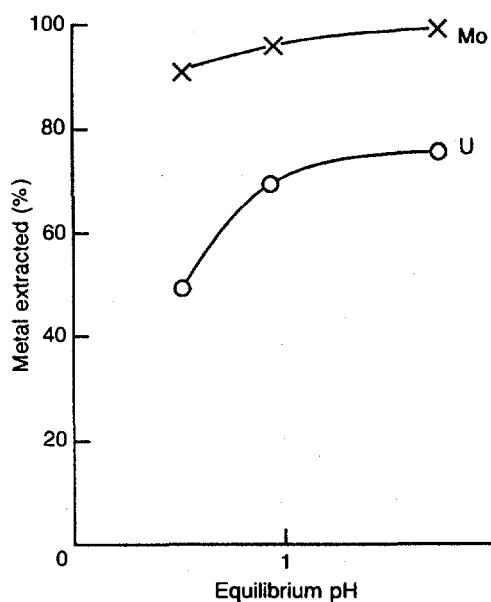

FIG. 7.18. Extraction of uranium and molybdenum with Alamine 336, from  $H_2SO_4$  solution. Feed, 1.01 g Mo/L and 1.00 g U/L; solvent, 0.1M Alamine 336 and 5% isodecanol in kerosine; A/O ratio of 3.

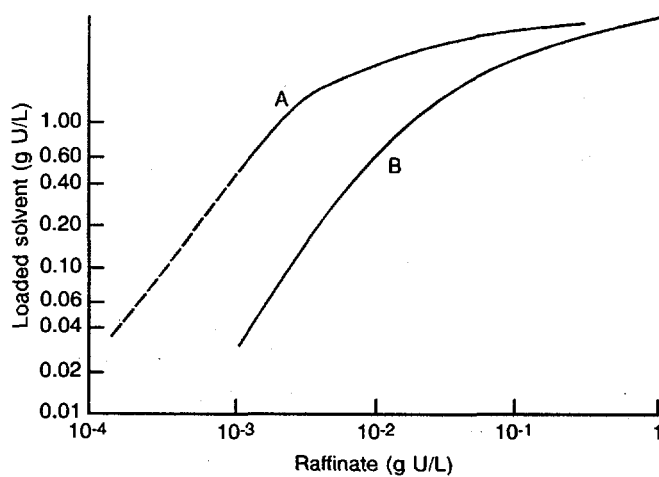

FIG. 7.19. Effect of chloride concentration on extraction equilibrium: A, 0.8 g chloride per litre; B, 3.5 g chloride per litre.



process [7.54]. In addition, oxidized vanadium, if present, will be extracted and stripped together with the molybdenum [7.68]. Another impurity to the uranium circuit could be that of zirconium. If extracted, even in small quantities, it can present a problem in the stripping circuit in the form of a crud [7.69]. Zirconium co-extraction can be suppressed by the addition of phosphate. Although iron is not extracted it can be absorbed onto the organic phase. This impurity can be removed prior to uranium stripping by scrubbing in water [7.54, 7.70]. If arsenic is present it will be removed in a scrub stage.

Feed solutions having a high chloride content will result in a decrease in the loading efficiency [7.71] as shown in Fig. 7.19. The high chloride ion content often arises from:

- (a) the salinity of the process water pumped from the wells at the site;
- (b) the use of excessive sodium chlorate additions in the oxidative leach;
- (c) the recycling of process water containing amounts of chloride;
- (d) the chloride elution of an ion exchange resin where the eluate is to be processed further by solvent extraction (ELUEX process).

Such solutions may be treated using an alkyl phosphate extractant [7.72], by an amine after first diluting the feed solution [7.72], or by extraction with TOPO [7.72].

Synergistic extraction of uranium with the tertiary amines can be accomplished with the addition of TOPO to the solvent to enhance the kinetics. However, the stripping is difficult [7.73]. The TOPO replaces the alcohol modifier usually used in such a system.

The extraction of uranium with a tertiary amine from a sulphate solution can be represented as follows:



The effectiveness of amines for the extraction from either sulphate or chloride media is in the following order:

quaternary > tertiary > secondary > primary

Amines can be used in sulphate or chloride media without a problem of amine degradation. However, the amines are degraded very quickly in the presence of nitrates or nitric acid, or at high oxidation potential in the leaching solutions. This problem of oxidation degradation has occurred in several mills when excessive amounts of sodium chlorate oxidant have been added in the leach, resulting in an electromotive force (EMF) of much greater than 600 mV, and thus in amine degradation. Obviously, good EMF control is necessary to prevent oxidation and excessive losses of the reagent.

### 7.3.2.3. Neutral extractants

Tri-*n*-butyl phosphate has been used very extensively in the nuclear field, but primarily for the refining of the mill grade uranium product to high purity uranium compounds such as  $\text{UO}_3$ ,  $\text{UO}_2$  and  $\text{UF}_4$ . Only one mill has used the TBP- $\text{HNO}_3$  process [7.48]. The TBP- $\text{HNO}_3$  system has also been used successfully for the production of a refined zirconium metal for nuclear fuel cladding [7.74]. TOPO has been used in the recovery of by-product uranium from phosphoric acid liquors.

### 7.3.3. Modifiers

The addition of a modifying reagent to the extractant-diluent mixture may be necessary in order to:

- (1) Improve the rate of phase disengagement following mixing;
- (2) Increase the solubility of the extracted species in the organic phase, and thus prevent the formation of third phases;
- (3) Decrease the emulsion and the tendency for crud formation.

The necessity for the use of modifiers and the choice of a particular modifier for the system in question are usually only determined by tests. The most common modifiers in uranium processing have been TBP for the DEHPA system, and long chain alcohol molecules in the tertiary amine system. The most commonly used alcohol has been isodecanol. However, there seem to be sufficient indications from plant operations that with continued use and recycling of the solvent mixture the isodecanol is oxidized to isodecanoic acid, and therefore degraded. The addition of a modifier is therefore required to make up the degradation loss. An apparently more stable modifier to oxidation, and one that is now being used by some operations, is tridecanol.

In the selection of a modifier it must be remembered that the diluent selected for the particular process may, in combination with a modifier, give quite different characteristics compared with another diluent with the same modifier. Thus any tests should be carried out with a modifier in different diluents. An example of modifier-diluent combinations in an amine and uranyl sulphate system is shown in Fig. 7.20 [7.54].

TOPO has been used in combination with DEHPA for processing phosphoric acid for uranium recovery. In the amine system the addition of TOPO instead of long chain alcohols has shown a definite benefit, in particular with increased kinetics. Although difficult to strip, one can anticipate a use in the future for the amine system for the recovery of uranium from sulphuric acid liquors.

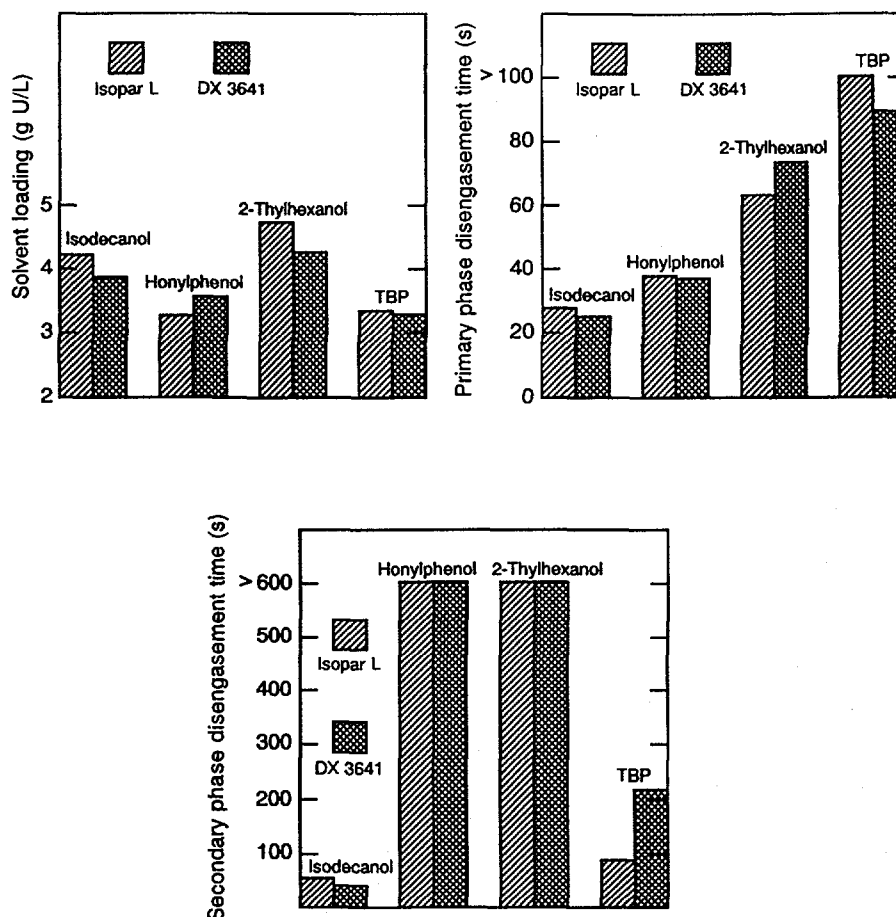

FIG. 7.20. Effect of modifier-diluent combination in an amine and uranyl sulphate system: (a) extraction of uranium with Alamine 336, (b) primary phase separation in extraction, (c) secondary phase separation in extraction.

#### 7.3.4. Diluents

The diluent is generally the major part of the solvent phase, except in systems in which TBP might be used as the extractant. In such systems, up to 100% TBP may be used without any diluent being required, or a modifier. For many years the diluent was considered to be inert and only the carrier for the active extractant, with no real chemical or physical function to the system. This myth has been dispelled

gradually over the past few years, and indeed the diluent does play an important part in the extraction process [7.54, 7.75, 7.76]. Various kerosine type diluents have been used, and the process has been greatly improved by the introduction of 'tailor-made' diluents with optimum blends of aliphatic and aromatic constituents to enhance not only the phase separation characteristics, but also the chemistry of the solvent extraction and separation process. Diluents other than the kerosine type and heavier than water have been investigated, in particular perchloroethylene [7.54, 7.77, 7.78]. With the heavy diluents the phase separation is usually faster, and metals discrimination is often improved as compared with the aliphatic and aromatic kerosines. The importance of the flash point is now widely recognized in the choice of diluent, and most plants select a diluent with a flash point greater than 50°C. The diluent composition with regard to the aliphatic, aromatic, paraffinic and naphthenic contents, together with the solvency parameter, all have a bearing on the evaluation and selection of the best diluent for a system. The solubility or solvency parameters are terms developed by the manufacturers. They can be calculated from the heat of vaporization,

$$\sigma = \frac{(\Delta H_v - RT)^{1/2}}{M/D}$$

or from surface tension,

$$\sigma = 3.75 \left( \frac{P}{(M/D)^{1/3}} \right)^{1/2}$$

where

- $H_v$  is the latent heat of vaporization (cal/mol),
- $R$  is the gas constant (1.987 cal/mol) (K),
- $T$  is the temperature (K),
- $M$  is the molecular weight,
- $D$  is the density (g/cm<sup>3</sup>),
- $P$  is the surface tension (dyn/cm).

Because the diluent composition affects the solvency and therefore the chemical and physical properties of the extraction, scrubbing and stripping, many diluents are now supplied in a blended form so as to contain a small amount of aromatics and perhaps of paraffins. Because each leaching solution is peculiar to the particular ore and process conditions, the choice of diluent must be based on tests with selected modifiers on a particular leaching solution. The selection of a diluent should not be arbitrary, or be based on costs alone, or chosen because another seemingly similar operation is using a particular diluent.

TABLE 7.2. SOME COMMERCIAL DILUENTS

Diluent	Company	Flashpoint (°C)	Components (%)			Specific gravity at 20°C	Boiling point (°C)	Viscosity at 0°C (cP)	Kauri butanol	Solubility parameter
			Aromatic	Paraffins	Naphthenes					
Isopar L	Exxon	63	0.3	92.7	7.0	0.767	190-206	1.34	27	7.2
Isopar M	Exxon	77	0.3	79.9	19.7	0.784	207-254	2.46	27	7.3
Norpar 12	Exxon	69	0.6	97.9	1.1	0.750	188-217	1.26	23	—
Escaid 100	Exxon	77	20	56.6	23.4	0.790	200-238	1.78	—	—
Escaid 110	Exxon	77	0.6	39.9	57.7	0.800	196-235	2.51	—	—
Escaid 200	Exxon	67	2.7	51.8	45.4	0.796	188-217	2.30	—	—
Escaid 300	Exxon	93	0.7			0.760	228-236	2.40	—	—
Escaid 500	Exxon	118	0.01			0.770	252-272	3.30	—	—
Solvesso 100	Exxon	42	99.0	1.0	0	0.876	156-170	0.79	92	8.8
Solvesso 150	Exxon	66	99.0	1.0	0	0.895	184-208	1.10	95	8.7
Kermac 467	Kerr-McGee	71	7.0	65.3	27.7	0.816	196-242	—	28	—
Kermac 470	Kerr-McGee	80	17.3	34.1	48.6	0.811	207-256	2.10	33	—
Shellsol AB	Shell	63	99.5	<1	<1	0.895	181-212	1.19	—	—
Shellsol 2046	Shell	80	16.0	44.0	40.0	0.808	207-240	1.97	—	—
Shellsol 140	Shell	60	5.0	45.0	50.0	0.785	179-203	—	32	—
Shellsol 2037	Shell	80	1.0	65.0	35.0	0.806	207-240	2.34	—	—
Shellsol 2358	Shell	106	1.0	58.0	42.0	0.807	235-280	3.33	—	—
Shellsol 160	Shell	73	1.0			0.802	207-310	—	—	—

Some commercial diluents are shown in Table 7.2, together with several important properties of the product.

### 7.3.5. Stripping

Stripping is usually considered the reverse of extraction, and can often be accomplished by a change in the hydrogen ion concentration or pH. This is the case when extraction with either an amine or an alkyl phosphoric acid has been carried out. With ion association and solvating systems, such as with the extraction with TBP from nitrate or chloride solutions where high salt or acid concentrations are required for metal extraction, stripping with water is successful.

There are several possible stripping solutions that can or have been used in the recovery of uranium from the loaded solvent.

In early circuits sodium carbonate was used. Later, controlled pH stripping with ammonia-ammonium sulphate solution was introduced and has been the most popular. This is in spite of the most difficult pH control necessary in order to prevent precipitation of uranium and thus the formation of very stable crud and high solvent losses as a result.

In the case of systems that have molybdenum present and therefore extracted with the uranium, a sodium chloride stripping process has been successful in the recovery of the uranium without co-stripping the molybdenum. In such situations the molybdenum is subsequently stripped with a sodium carbonate solution.

Other stripping agents have included sodium sulphate or ammonium carbonate. The latter method has the advantage of producing an ammonium uranyl tricarbonate strip solution, which can be subsequently treated to produce ammonium uranyl carbonate as a product. This product can be readily converted to  $\text{UO}_2$ ,  $\text{UO}_3$ ,  $\text{U}_3\text{O}_8$  or  $\text{UF}_4$ .

Thus, the choice of stripping solution should be dictated by the type of product and product specifications, the ability to control the reaction to minimize crud or precipitate formation, the possibility of recycling the barren uranium solution from precipitation back to the stripping circuit, the environmental impact due to disposal of the barren strip to tailings impoundment and the overall economics.

### 7.3.6. Dispersion and coalescence

Of major importance in solvent extraction processing are those aspects concerned with the physical mixing and separation of the aqueous and solvent phases. In dispersing one phase in the other we can define two extreme situations, one a temporary dispersion from which the dispersed phase rapidly coalesces and separates from the non-dispersed or continuous phase, and one in which a stable emulsion is produced.

Rapid coalescence of the dispersed phase after mixing is desirable. However, depending upon the chemical system of mass transfer with respect to the extractant and the kinetics, inadequate or excessive mixing will thus result in poor extraction and probably a fast phase separation, or in good extraction and a slow coalescence because of the extremely fine droplets. Mass transfer rates depend in part on the drop size distribution, that is the interfacial area of the dispersed phase. Generally the smaller the droplet the better the mass transfer. However, as the drops become smaller and smaller with increased energy input to the mixer, the drops behave as rigid spheres, with the result that the mass transfer decreases.

The physical as well as the chemical aspects of the system will be governed in part by the continuous phase. The direction of the mass transfer usually influences the choice. Most plants arbitrarily run the extraction stages as organic continuous. However, it is wise to examine the relative differences in a small scale minicircuit before determining the plant or pilot plant conditions. The best results involve a compromise between the ideal operating conditions that would provide the maximum mass transfer, coalescence, the desired throughput in the system, and little or no crud formation. If there are solids or an appreciable number of hydrolysable ions present, then the choice of phase ratios and phase continuity can become very important.

Coalescence can be divided into two stages, first the primary break, which is the separation of the major portion of the phases, and then the secondary break, which can be an indication of significant solvent losses if the break time is long.

Various devices can be employed in order to increase the rates of coalescence and therefore decrease the solvent losses by entrainment. Aftersettlers have been used, as well as in-line coalescers, wetting materials, such as Teflon or Teflon-steel screens, various baffles, placed vertically or horizontally or at various angles, air flotation and activated carbon. These methods are used to reduce the entrainment or improve coalescence, but ideally the objective would be to prevent the formation of such obviously stable emulsions in the first place. This can be accomplished by selection of the right type of contactor for the particular liquid-liquid system, and by proper operation of the equipment so as to minimize excessive shear while still maintaining the desired mass transfer.

### 7.3.7. Contacting equipment

In order to arrive at the proper decision in the choice of a contactor or contactors for the process, there must be an understanding of the physical aspects of the process. These are primarily concerned with the dispersion of the two phases on mixing, the size of droplet, and the rate and completeness of the coalescence process. The settling area required is dependent upon the rate of coalescence, which is dictated by the droplet size. In addition, the kinetics of the system, together with the dispersion and coalescence, will influence the choice of the contactor. Systems with slow kinetics, for example, demand greater dispersion and contact time, so that

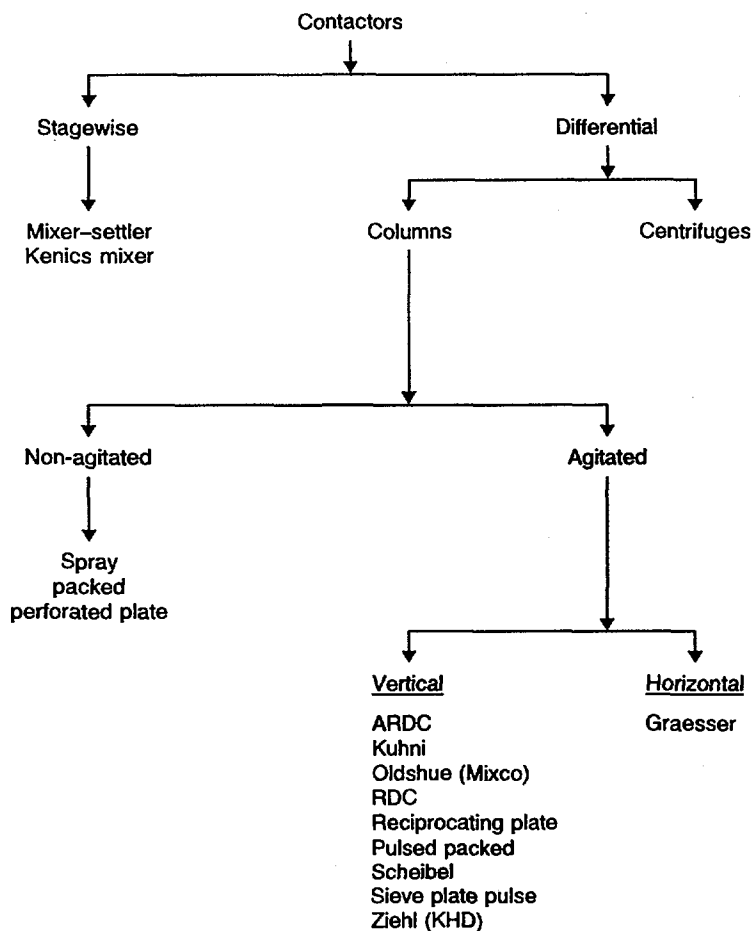

FIG. 7.21. Contactor classification.

mixer settlers could probably be used; whereas in a fast kinetic system the choice of contactors becomes wide.

The major emphasis in the development and optimization of equipment for the solvent extraction process has been to increase the throughput while maintaining the efficiency, and to increase the efficiency without reducing the throughput. However, with all the equipment available and the amount of engineering data produced on synthetic systems, many without chemical reactions taking place, very little can be predicted regarding the scale-up without first running at least a small continuous pilot plant on the actual process feed solution.

It should be emphasized that there is no 'universal contactor' that is suitable for all processes, because of the many variables that have to be considered. Thus a



TABLE 7.3. EQUIPMENT PERFORMANCE

---

**Mixer settlers***Advantages*

- good contacting of phases
- handle wide range of flow ratio (with recycle)
- low headroom
- high efficiency
- many stages
- reliable scale-up
- low cost
- low maintenance

*Disadvantages*

- large holdup
- high power costs
- high solvent inventory
- large area required
- interstage pumping may be necessary

**Non-agitated differential***Advantages*

- low initial cost
- low operating cost
- simplest construction

*Disadvantages*

- limited throughput with small gravity difference
- cannot handle wide flow ratio
- high headroom
- occasional low efficiency, depending upon kinetics
- difficult scale-up

**Agitated differential***Advantages*

- good dispersion
- reasonable cost
- many stages possible
- relatively easy scale-up
- certain types (pulse columns) can handle solids, high flow ratios and emulsifying conditions

*Disadvantages*

- limited throughput with small gravity difference, with the exception of pulse columns
  - cannot handle solids or emulsifying conditions, except the pulse columns
-

TABLE 7.3. (cont.)

---

**Centrifugal***Advantages*

- handle low gravity difference
- low holdup volume
- short holdup time
- small space requirements
- small solvent inventory

*Disadvantages*

- high initial cost
  - high operating cost
  - high maintenance
  - limited number of stages in most units, although some units have up to 20 stages
- 

plant that may require mixer settlers for extraction might select columns for scrubbing and centrifuges for stripping. This is quite a different philosophy from that of most plants, where the same type of contactor has been selected for extraction, scrubbing and stripping. The economics of the choice of the most suitable contactor for the particular operation must be considered with respect to particular conditions of solutions and solvent type, throughput, kinetics and equilibrium, dispersion and coalescence, solvent losses, corrosion, number of stages and available area.

Although there are many types and designs of solvent extraction contactors available, the mixer settler has been the most widely used contactor, originating with the gravity-type design, followed by the pump-mix design and its many modifications in pump design and settler configuration [7.54]. The mixer settlers are claimed to be ideal as they are inexpensive, are easy to fabricate, have minimal control problems, are usually easy to cleanse of entrained solids or cruds, and are easily scaled up for plant design. However, they do have a large solvent holdup and occupy a large area, which can be expensive if a heated building is required, and the combined pumping-mixing provides an extremely high shear to the process solution and the solvent mixture. This shear is high because of the necessity for interstage pumping, and so droplets are produced that are smaller than necessary to produce mass transfer. Consequently, stable emulsions and, often, cruds are produced, in particular if the feed solution to solvent extraction has not been sufficiently clarified, and if the settler design is inadequate.

Mass transfer in solvent extraction processing is usually accomplished in continuous countercurrent equipment. Contactors can be classified as stagewise (mixer settlers) and differential contactors (columns). This classification is shown in Fig. 7.21 [7.54]. Some of the major advantages and disadvantages of the various contactors are shown in Table 7.3 [7.54].

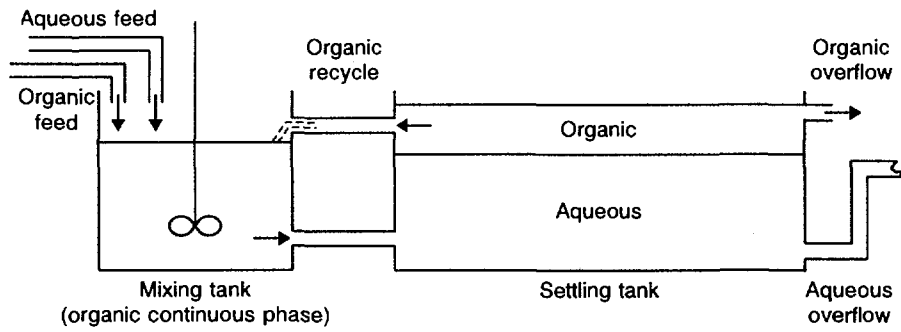

FIG. 7.22. Mixer settler diagram.

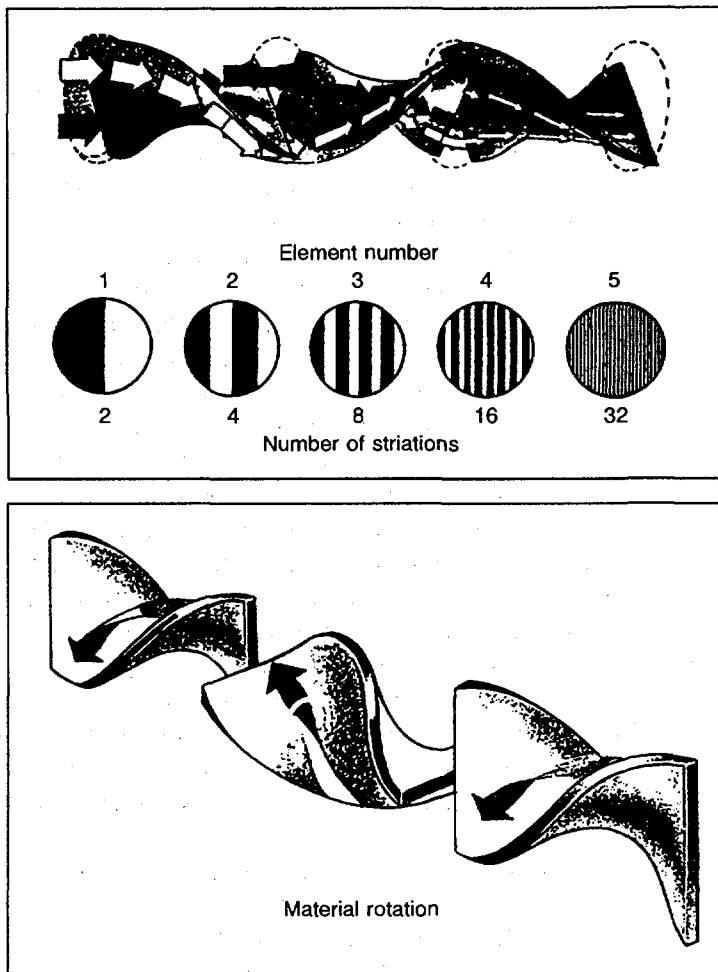
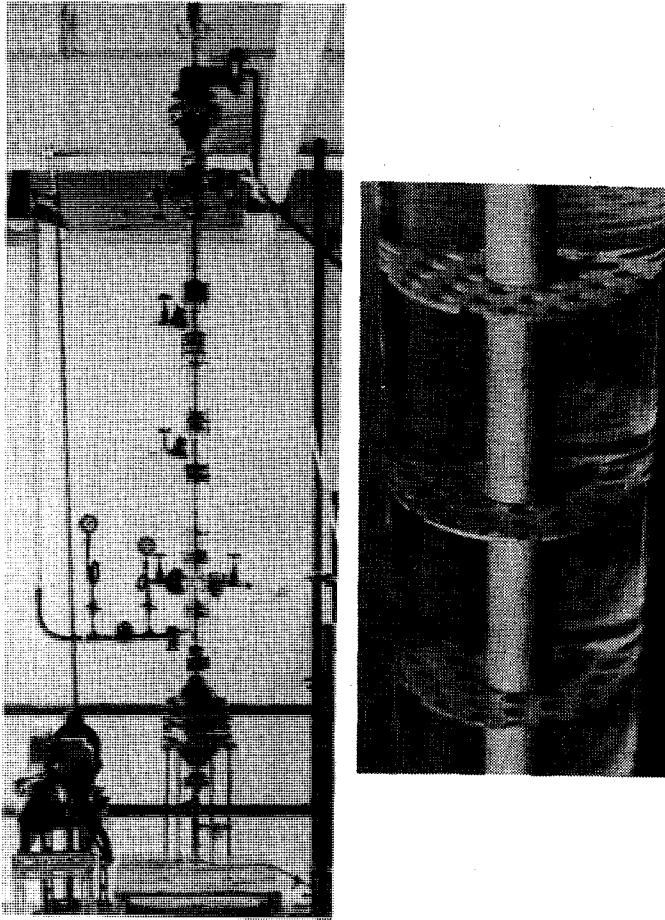

FIG. 7.23. Kenics mixer.



*FIG. 7.24. Sieve plate pulse column.*

Figures 7.22 to 7.27 show some of the more common contactors [7.54]. Included are the mixer settler, the in-line contactor (Kenics mixer), the sieve plate pulse column, the Krebs mixer settler, the Davy McKee combined mixer settler (CMS) and the RTL contactor.

The performance of gravity settlers has been improved by the use of vertical baffles and picket fences [7.79, 7.80] and the general aspects of mixer settler design have been well documented in recent years [7.81–7.83]. In addition to baffles to improve coalescence, work on packing or coalescing materials have increased the capacity of the settlers [7.84].

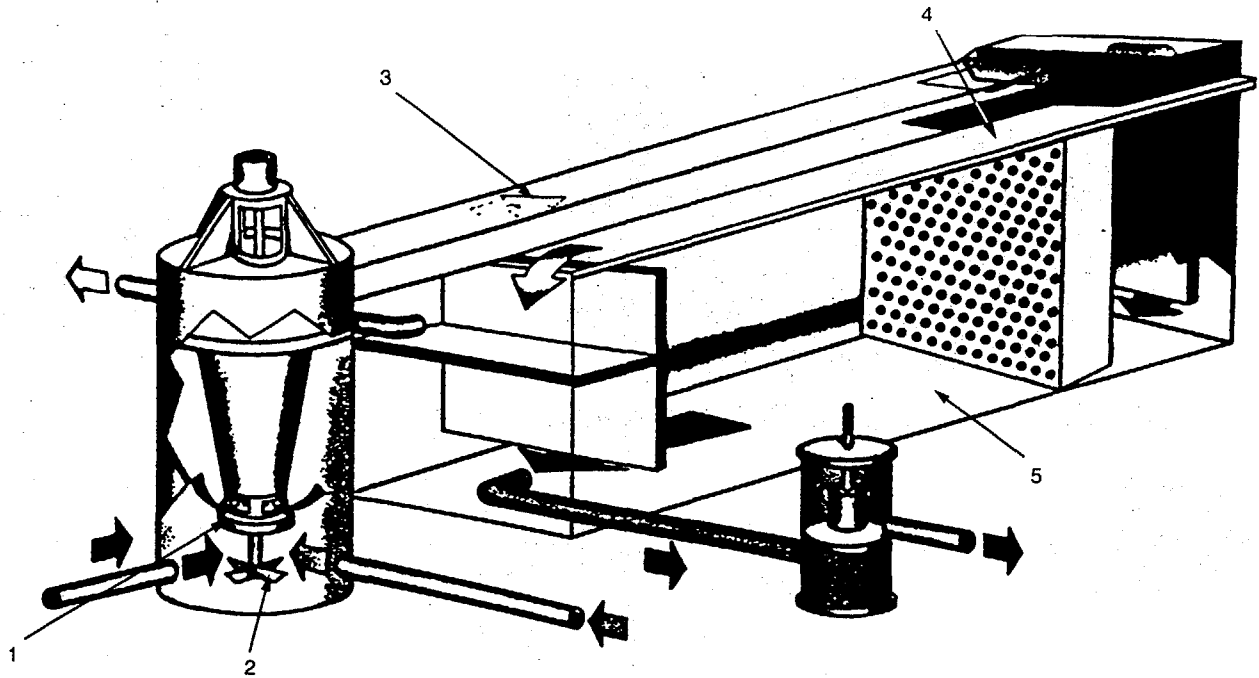
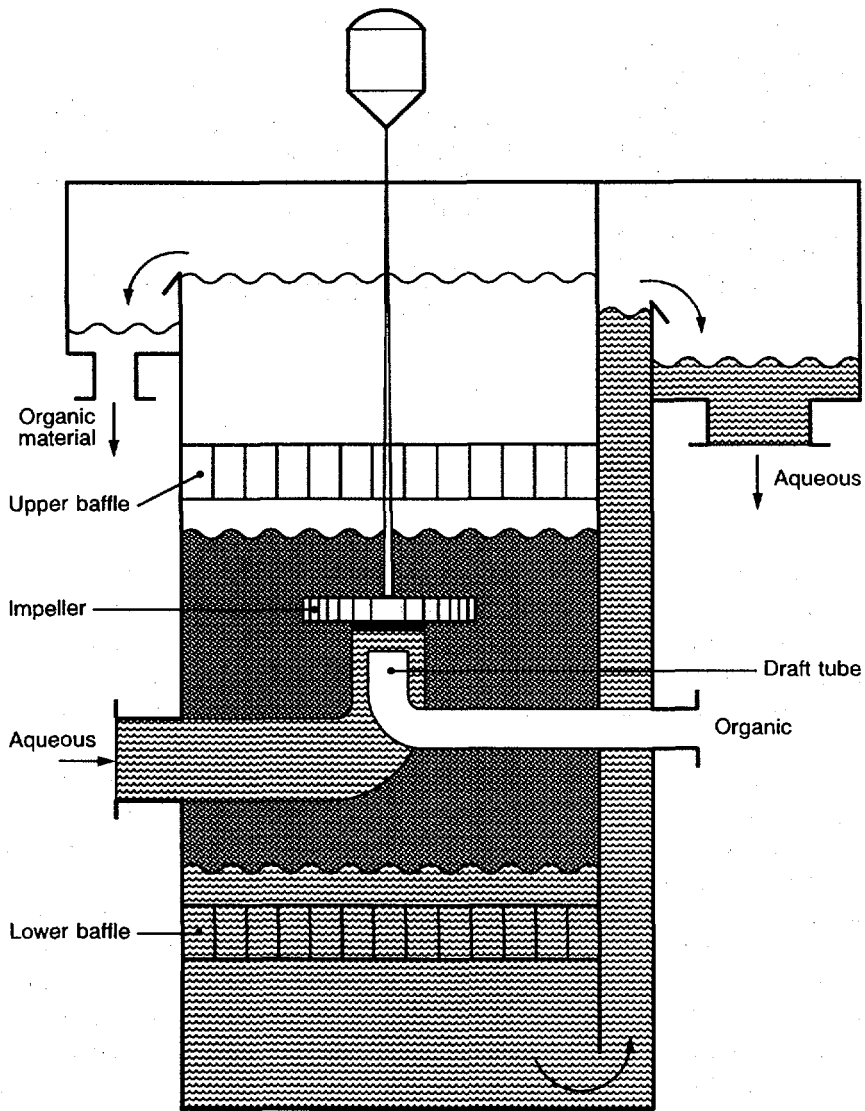

FIG. 7.25. Krebs mixer settler: 1, conical pump to provide liquid transfer and enhance phase coalescence; 2, agitator selected on the basis of mixing requirements; 3, superimposed launder providing further phase separation; 4, removable covers; 5, settler for final separation.



**FIG. 7.26.** Davy McKee combined mixer settler; white, organic phase; dark, mixed phase; stippled, aqueous phase.

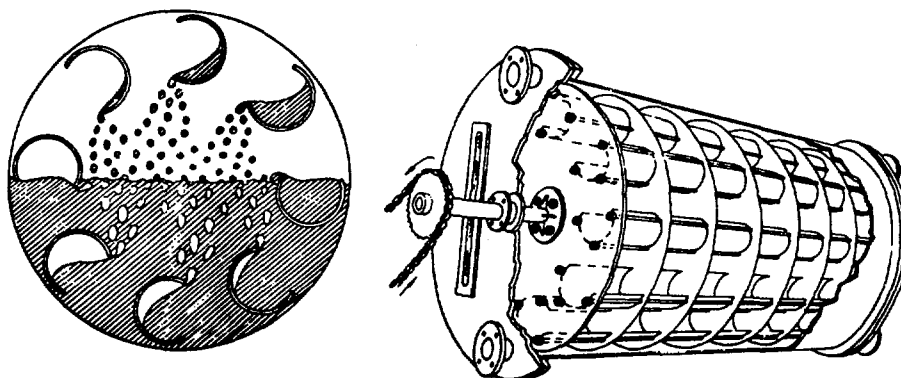

FIG. 7.27. RTL (Graesser) contactor.

Many plants using a high shear design of mixer settlers must clarify the feed solution to solvent extraction to less than 30 ppm solids to minimize crud formation. In the past few years there has therefore been more concern as to the generation of crud, its cost in solvent loss, and the concern for the environment receiving the solvent that would be discharged to the tailings. The crud often contains up to 80% or more of organic material.

Solvent losses, and those attributed to the formation of crud, can be caused by many variables in the process, both chemical and physical [7.54, 7.85–7.88], and various crud treatment methods have been proposed [7.85]. Work on a uranium circuit that generated a considerable amount of crud in both the extraction and stripping circuits was carried out by CANMET, Ottawa, first to analyse and characterize the crud and then to develop technology to treat solutions successfully and minimize or eliminate the formation of crud [7.88]. The data indicated that there was a relationship between the composition of the feed and the crud analysis, with much of the crud due to fine carry-over from insufficiently clarified feed. The usual inorganic constituents in the cruds examined are Si, Al, Fe, Mg, Ca and U. Strip cruds, in uranium circuits, contain large amounts of uranium, usually due to poor pH control in the  $\text{NH}_3$ – $(\text{NH}_4)_2\text{SO}_4$  stripping circuit. Iron and silica can be carried over from the extraction circuit and produce a crud in the stripping circuit unless a wash stage is inserted after the extraction stage. Other organic compounds, such as lignin or humic acids in the feed solution, can cause crud formation [7.89].

As part of the investigation on crud formation various types of contactors were examined as to their relative performance with respect to crud formation [7.89]. The pump-mix design could only tolerate 30–50 ppm suspended solids. However, with

pulse sieve plate columns, Kenics in-line mixers, or the RTL contactor, greater than 50 ppm suspended solids could be tolerated.

The equipment manufacturers now have a much better appreciation of the problem of high shear and stable emulsions and cruds, and the recent designs of mixer settlers have demonstrated minimum shear, but sufficient to provide the desired mass transfer. The Krebs mixer settler [7.90, 7.91] is of an improved design and has quickly gained acceptance since 1975, with uranium plants incorporating the contactors in Gabon, France, South Africa, the USA, Canada and Australia. The pumping and mixing are independent, while the mixed phases flow from the mixer through a launder, providing for a certain amount of phase separation before actually entering the dispersion zone in the settler. Such a design permits for three to four times the flow capacity of the usual pump-mix design. This mixer settler could probably tolerate more solids in the feed solution than the high shear designs.

Davy McKee have developed a contactor to minimize turbulence, which is called the combined mixer settler (CMS) [7.92-7.94]. It consists of a single vessel in which three zones exist during operation: the upper separation zone (organic phase), a lower separation zone (aqueous phase) and a central zone comprising the dispersed phases. Weirs can be adjusted to maintain the interfaces, and the design eliminates the requirement for recycling of the minor phase. Thus the area and coalescing requirements are reduced compared with conventional settlers. In addition, the design can accommodate up to 300 ppm of solids without generation and accumulation of crud. The unit has been reported to be successful. A four stage pilot circuit was run at Buffelsfontein, South Africa, at a scale of 12 m<sup>3</sup>/h feed. A demonstration unit treating 100 m<sup>3</sup>/h feed was installed at Randfontein Estates Gold Mining Limited, in which each unit was 4.5 m high, having a cross-sectional area of 3.24 m<sup>2</sup> [7.47]. A successful unit was also installed for the TOTAL Compagnie Minière, France. A similar design, in some aspects, was proposed by Kuhni (see Ref. [7.95]). Subsequently, Davy McKee have installed plants at flow rates of 250 and 700 m<sup>3</sup>/h [7.93]. A cost saving of about 30% over conventional mixer settlers is claimed, together with lower operating costs.

As noted earlier, the main type of contactor in the uranium and base metals industries has been variations of mixer settlers. The recognition that extreme agitation and shear are not always necessary to achieve mass transfer and that contactors other than mixer settlers could be used has been successfully demonstrated using pulse columns. Two uranium plants in France have used the pulse columns successfully [7.96]. These are the TOTAL Compagnie Minière (formerly Donj Trieu) Jouac plant since 1979 and the Simo de Bessines plant since 1981. Pulse columns are used effectively in these plants for the extraction of uranium from the sulphuric acid leach solution, with only a small amount of crud being generated. The small amount of crud accumulates at the interface, and is withdrawn periodically from the column. The use of this type of contactor could be considered in certain applications for solvent-in-pulp processing, thus eliminating the costly solid-liquid separation



stage [7.54, 7.97]. This process is discussed later in this chapter. The use of the pulse columns results in:

- (a) fewer solvent inventory requirements;
- (b) fewer pumps, as there will be more than one stage in a column;
- (c) variability of high phase ratios;
- (d) ease of control;
- (e) low shear so that systems that tend to form stable emulsions can be processed;
- (f) low maintenance;
- (g) ability to process liquors that may otherwise oxidize if contacted in a mixer settler because the column can be closed;
- (h) the possibility of treating slurries.

Thus, with respect to equipment for processing of uranium or other metals, consideration of many parameters is necessary if the best contactor for the particular application is selected. While mixer settlers have been the most popular there is now an increasing interest in the possible application of the differential type of contactors, such as the sieve plate pulse columns, for treating solutions for uranium recovery. Many references to column contactors and to their design are to be found in the literature [7.54, 7.67].

#### **7.3.8. Solvent-in-pulp extraction**

If a substantial reduction in processing costs is to be achieved in a mill then the solid-liquid separation stage must be eliminated. This costly operation accounts for up to 50% of the capital and operating costs of the mill. Such a possibility exists in the use of RIP continuous ion exchange or in SIP extraction from the leach slurry [7.54]. There have been a number of publications on the subject of SIP, arising from research and development in Canada (by Ritcey and co-workers over many years [7.97-7.100]) in which the first successful pilot plant trials were made, but no plant was installed. Pulse columns were the most successful contactors because of the low shear compared with other contactors, which minimized stable emulsions and crud formation. There is, at present, renewed activity in several research laboratories and plant operations to develop suitable equipment and technology to accomplish such a goal. The Beijing Research Institute of Uranium Ore Processing, and the Hengyang Uranium Mill, both in China, are engaged in a considerable amount of research on SIP extraction, using sieve plate pulse columns and other equipment designs [7.101].

Although the research in Canada was successful in establishing much of the fundamentals and producing small demonstration plants, the technology still required to be developed commercially. Such a plant has now operated in China for over ten years, based on the previous work in Canada that was carried out by Ritcey et al. Since 1969, there have been extensive studies on the possible application of SIP

to the recovery of uranium from slurries possessing a range of minerals with varying characteristics. At the Beijing Research Institute of Uranium Ore Processing the investigations included conventional atmospheric sulphuric acid leaching, acid pressure leaching and pressure leaching of a water-ore slurry. The highest recoveries in the leaching stage were obtained by atmospheric acid leaching of coal ash [7.102, 7.103]. The initial flow sheet consisted of leaching, filtration and solvent extraction recovery of the uranium with a tertiary amine. That plant operated for six years. However, with the success in the research on extraction from the slurry, the flow sheet was modified to that of an SIP plant. This is shown in Fig. 7.28.

Following the combustion of the powdered lignite to generate electric power the ash was leached with sulphuric acid. The leach slurry was diluted to a solid-liquid ratio of 1:5 and the extraction was maintained at a pH value of between 1 and 1.2. Coarse particles were removed by screening, and the slurry, containing 70% -300 mesh material, was sent to a storage surge tank. The slurry feed (solution) analyses were 0.7 to 1.1 g/L U and 5 to 13 g/L SiO<sub>2</sub>. The throughput was 45 m/h.

Extraction of the uranium took place in a sieve plate pulse column having the dimensions of 0.5 m diameter and containing 10 m height of extraction section in which the polychloroethylene plates were spaced 5 cm apart. The hole size of the plates was 0.8 cm diameter, and the free area of the plates was 25%. Agitation was accomplished using a pulse frequency of 35 per minute at an amplitude of 2.4 to 3.6 cm.

From the storage tank the slurry entered the top of the sieve plate pulse column. This down flow of slurry was contacted with upflowing solvent entering near the bottom of the column. The regenerated acidified solvent mixture consisted of 0.064M tri-fatty amine (TFA) extractant and a 2.4% alcohol modifier dissolved in a kerosine diluent. The raffinate passed out through the bottom of the column and into a modified thickener, was diluted with water, and any entrained solvent recovered from the surface. The crud was broken by using a continuous centrifuge (type T-80) to recover the solvent which was sent to the modified thickener.

An extraction of uranium of more than 99% was obtained. The loaded solvent, flowing from the top of the column, contained from 4 to 5 g/L of uranium.

There were a number of apparent benefits to be gained by using the SIP process, which included the following:

- (a) The improvement in the economics was significant, as is shown in Table 7.4 [7.102].
- (b) The considerable difference in the uranium recovery between extraction from clarified solutions and the SIP process was due to the following factors:
  - (i) The slurry was very fine and contained carbon particles enriched in sorbed uranium, which was lost when filtered.
  - (ii) The uranium was recovered from the third phase; the solids of the third phase, high in carbon, contained 0.1 to 0.2% uranium.

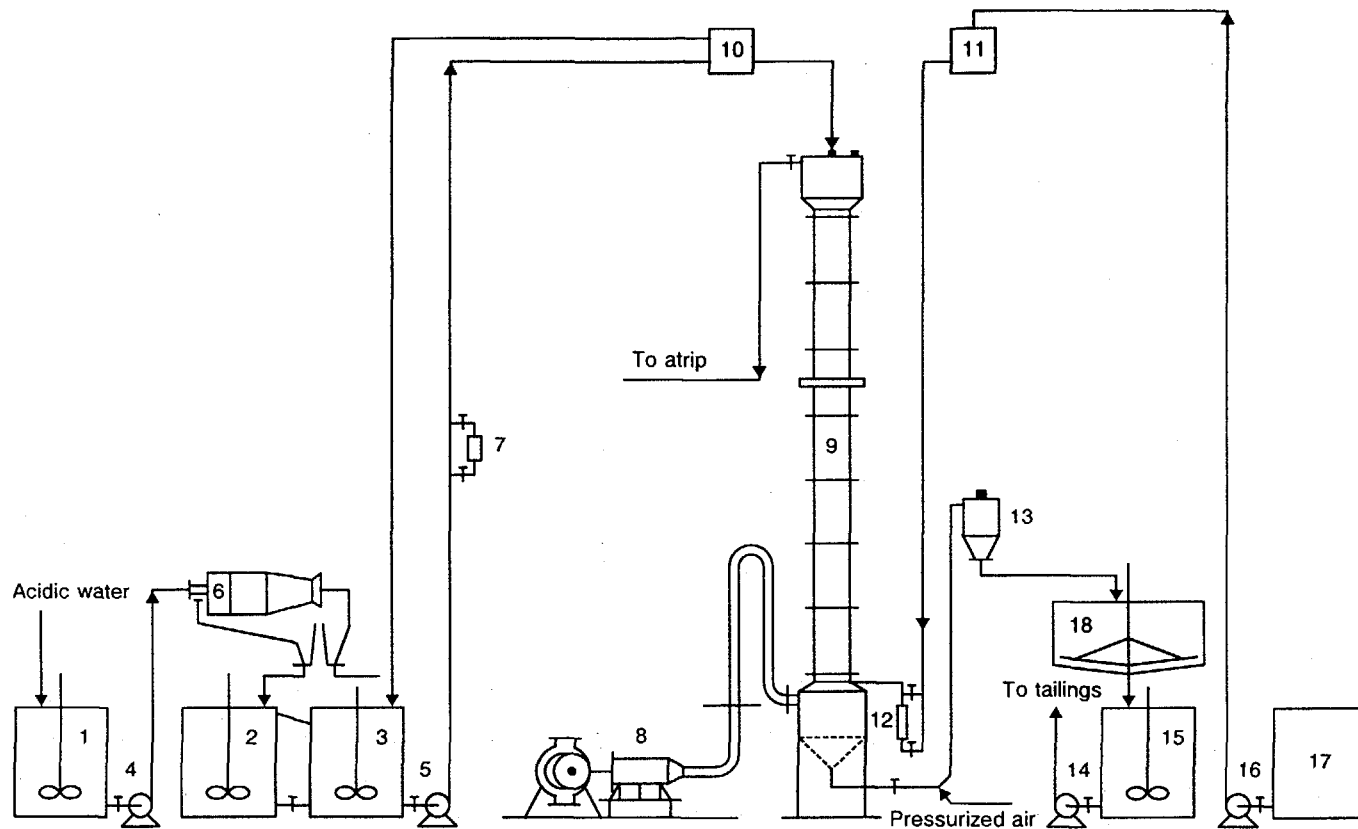

FIG. 7.28. SIP process flow sheet (China): 1, slurry tank; 2, 3, agitator tanks; 4, 5, 14, stainless steel pumps; 6, hydraulic screen; 7, electromagnetic flow meter; 8, mechanical pulse pump; 9, perforated plate column; 10, slurry surge tank; 11, solvent head tank; 12, flow meters; 13, gas-liquid separator; 15, agitator tank; 16, centrifugal pumps; 17, barren solvent storage tank; 18, thickeners.

TABLE 7.4. SIP COST ADVANTAGE

Flowsheet type	Rec'Y (%)	Operators	Power (%)	Maintenance cost (%)	Protection and safety
Clarified solution	100	>10	100	100	Very poor; open operation
SIP extraction	158	1	<10	<10	Closed; centralized control

- (c) The solvent loss, an important aspect of SIP, must be evaluated against other processes by consideration of:
- (i) The cost of filtration and washing.
  - (ii) The loss on particles (i.e. the 'soluble losses').
  - (iii) The recovery of the uranium from the third phase.
  - (iv) The fact that disposal of a slurry raffinate may be more favourable than disposal of a clear effluent because the tendency for hydrolysis to occur in a slurry produces a more stable effluent.
- (d) The solvent loss adsorbed on the particles was of the order of three to ten times as large as that lost to the raffinate.
- (e) Although the amine loss when run in organic continuous operation was higher by 20 to 30% than with aqueous continuous operation [7.103], the organic continuous operation was more reliable. Thus, the organic continuous mode of operation was adapted.
- (f) The amine loss on the solids was decreased to 0.013% by washing with water or raffinate.
- (g) Approximately 50 surfactants and flocculants were tested for the potential for reducing solvent losses. The polyacrylamide type resulted in a reduction to between 0.0052 and 0.0077%.
- (h) As the pH of the pulp increased from 0.9 to 1.1, 1.3 and 2.8 there was an increase in the amine loss of 17, 80 and 158%, respectively. This also occurred when operating with five other ore types. The optimum value of pH for SIP extraction may therefore differ from that for clarified liquors, and so control of pH is necessary to minimize losses.
- (i) The sieve plate pulse column, which controls the droplet size and the type of mixing, was easy to operate. It was concluded that the efficiency would not be decreased when the diameter was scaled up from 2.5 to 500 cm.
- (j) The results for the different types of feed materials indicated that the optimum amplitude and frequency in the extraction of uranium with TFA would be an amplitude of 2.4 cm and a frequency of 24 pulses/min or an amplitude of 2.4 cm and a frequency of 36 pulses/min.

- (k) During the initial period of operation the TFA, although having a high solubility, was found to be inexpensive. Alkyl phosphoric acid extractants were also considered to be a good choice for SIP.

It was concluded that with high rates of throughput the sieve plate pulse column would be suitable, while at low throughputs the Graesser (RTL contactor) contactor could be a better choice.

After more than ten years of operation in China the application of SIP extraction has proven quite feasible, particularly for richer ores, and where there is a difficult and expensive solid-liquid separation problem.

### 7.3.9. Solvent losses

Solvent losses in the process can have a major impact not only on the economics of the operation but also on the receiving environment owing to the discharge of process effluents from the solvent extraction circuit. These losses of solvent can be due to: (a) solubility, (b) volatility, (c) entrainment, (d) degradation and (e) stable emulsions and cruds. These losses have been discussed in detail by Ritcey [7.54, 7.89].

### 7.3.10. Process development

Several stages need to be considered in the development of the solvent extraction process flow sheet, and data are required such as:

- (a) Extractant selection and solvent composition;
- (b) Determination of the requirement for scrubbing and scrub solution;
- (c) Determination of the type of stripping solution;
- (d) Equilibrium data for both extraction and stripping, and scrubbing if necessary;
- (e) Kinetics of extraction, scrubbing and stripping;
- (f) Calculation of theoretical stages required for extraction, scrubbing and stripping for maximum process efficiency;
- (g) Dispersion and coalescence characteristics;
- (h) Selection of contactors, sizing of equipment for the desired throughput, mixing and settling volumes, and area requirements;
- (i) Product specifications and possible by-products;
- (j) Solvent losses;
- (k) Environmental impact;
- (l) Economic assessment.

In the choice of a suitable solvent (extractant, diluent, modifier) for a particular system, certain preliminary screening tests can be carried out in order to narrow the range of reagents to be tested. The solvent should have a very low solubility in the

aqueous medium and no degradation on recycling and it should not form a stable emulsion when mixed with the aqueous phases. These screening tests are normally carried out in separatory funnels in the laboratory. Initially, synthetic feed solutions are normally used in contact with perhaps 0.1M extractants in the diluent, at an aqueous to organic (A/O) ratio of 1:1 for five minutes contact time at room temperature. Later on the work is carried out with the actual leaching solution.

When the choice of possible extractants has been narrowed, as well as the choice of diluent and requirement for a modifier, additional shake-outs are performed to determine the following: specificity of the extractant for a particular metal, the loading capacity, the pH and temperature dependency, the kinetics of extraction and stripping, and the scrubbing and stripping characteristics. The usual measurement for comparison of data, from which the scaleup information and preliminary economics are derived, include the following [7.54]: per cent extraction (scrubbing, stripping);  $pH_{1/2}$  values (the pH at which 50% extraction occurs); extraction (scrubbing, stripping) coefficients, defined by,

$$\text{extraction coefficient } (E) = \frac{\text{concentration organic}}{\text{concentration aqueous}} ;$$

the separation factor (SF, the measure of the discrimination of one metal over another), defined as

$$SF = \frac{E(\text{metal 1})}{E(\text{metal 2})} ;$$

the distribution isotherm; and the McCabe–Thiele diagram to be discussed in the next paragraph. The distribution isotherm is constructed by variation of the phase ratios in bench scale shake-outs, or by repeated contact of the solvent with a fresh feed solution to determine the saturation loading for the particular system. This saturation loading value for the system is important because it governs the volume of solvent flow necessary to contact a fixed tonnage of feed solution. Such a plot is shown in Fig. 7.29, where the circles on the curve represent varying phase ratios, such as A/O being 1:5, 1:2, 1:1, 3:1, 5:1, 8:1 and 10:1.

Each process of mixing and separation of the organic and aqueous phases is considered a stage. Depending upon the number of theoretical stages, and therefore on the type of equipment possible, the feasibility of the process may be determined. Thus the equilibrium isotherm becomes of additional value when it is used to calculate the number of theoretical stages of extraction (scrubbing, stripping) to achieve the required organic saturation with a minimum loss of metal to the raffinate. This is known as the McCabe–Thiele diagram (Fig. 7.30). In the construction of such a diagram the extraction or equilibrium isotherm is plotted first and then a second line,

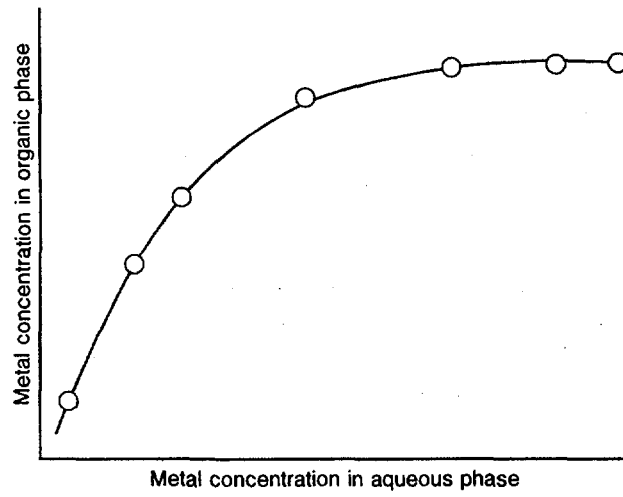

FIG. 7.29. Typical extraction isotherm.

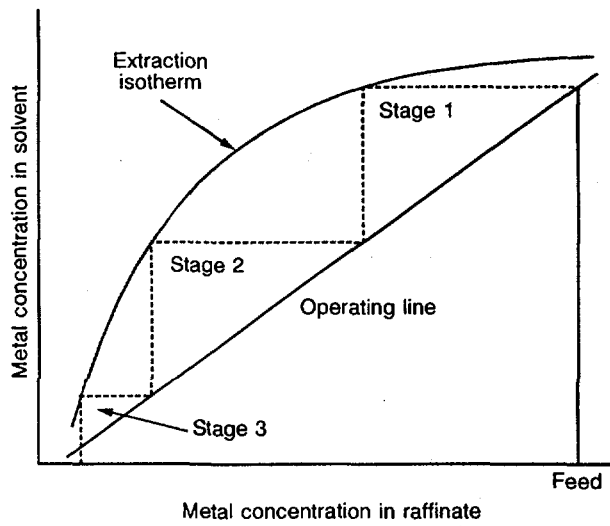

FIG. 7.30. McCabe-Thiele diagram.

known as the operating line (with a slope equal to the phase ratio), is drawn. The operating line is based on the mass balance of the system, and therefore the concentration of the metal in the solvent entering and in the aqueous raffinate leaving any stage are co-ordinates of points on the operating line. Similarly, the concentrations of metal in the aqueous feed entering and in the solvent leaving any stage are the co-ordinates of such points. The theoretical stages are stepped off by extending a horizontal line from the upper end of the operating line to intersect the extraction isotherm, and then drawn vertically downwards to intercept the operating line. This is continued until the lower end of the operating line is intercepted. Each step is called a theoretical stage.

In the example shown, slightly over three theoretical stages would be required. In actual practice, if mixer settlers were to be considered for extraction, a cascade of four contactors would be required. When multistage contactors such as columns or centrifuges are used, in which an extraction stage is not evident, the McCabe-Thiele diagram provides a guide, with experience, as to the column height required, or to the height equivalent to a theoretical stage (HETS). The McCabe-Thiele diagram permits the calculation of the extraction and stripping efficiency and the correlation of this efficiency with operating variables such as flow rates, contact time, degree of mixing and temperature. It is usually found that the speed with which equilibrium is attained is affected by the variables governing the rate of mass transfer, such as the feed, the type of solvent, the turbulence or degree of mixing, the temperature and the viscosity of the system.

Although the McCabe-Thiele diagram is very useful in the prediction of theoretical stages it must be emphasized that if there is a serious degree of co-extraction of other metals occurring then such a plot could be misleading, as sites on the solvent that would normally be expected to be occupied by uranium alone will be occupied by other contaminants and uranium. In such cases it would be useful to plot the respective metals separately, using synthetic solutions, in order to provide a guide as to the stage requirements.

In the development of a flow sheet upon which the plant design can be based, as well as the predicted costs of the process, the next stage is the running of a continuous circuit, usually in a series of small mixer settlers. These cells are usually very small, perhaps up to 200 mL capacity in the mixer. Such circuits can be run to verify the various operating parameters, such as number of stages, flow ratios, temperature, kinetics, phase continuity, and the physical aspects such as dispersion and coalescence, emulsions and crud formation. With continued recycling some idea of possible solvent degradation and losses can be attained. Following plant startup these small circuits can be used to 'trouble shoot' the process and thus assist in the ultimate optimization of the process. Neat and compact designs are available from several suppliers, or can be constructed in the laboratory.

After sufficient data have been obtained to assemble a conceptual flow sheet, the next stage in the process development is to construct and operate a pilot plant.



A pilot plant can be of any size depending on the experience and philosophy of the company, but a feed rate of between 5 and 10 L/min is a reasonable size for most investigations. Typical information obtainable from pilot plant operations are:

- (1) Aqueous and solvent flow rates (L/min), phase ratios and recyclings within stages;
- (2) Number of extraction stages required; stage volumes (size of mixer);
- (3) Scrub details;
- (4) Number of stripping stages required;
- (5) Contact times to maximize metal transfer while being discriminating with impurities;
- (6) Settling area requirements,  $L \cdot \text{min}^{-1} \cdot \text{m}^{-2}$ ;
- (7) Temperature requirements, for kinetics or to improve phase separation;
- (8) Recycling requirements, L/min;
- (9) Analyses of aqueous and organic phases, solvent losses and product purity;
- (10) Metal(s) separation efficiency;
- (11) Power requirements;
- (12) Anticipated plant capital and operating costs;
- (13) Scaleup data for plant;
- (14) Training of personnel.

Pilot plant operations should, perhaps in the early stages, be run on at least a 12 h continuous basis and then later in the campaign to a 24 h schedule until sufficient data and experience have been acquired to scale up the process confidently to plant requirements.

### 7.3.11. Materials of construction

Because there are many alternatives often available in the choice of materials of construction for the solvent extraction plant, each plant designer and contractor must choose carefully, and the requirements are really site specific. The ultimate selection can greatly affect the plant costs — from both the capital and the operating standpoint, because of corrosion problems, frequency of maintenance and often poor metallurgy resulting from corrosion or degradation problems. Where existing plants are in operation, the knowledge and experience derived from those plants can be invaluable.

With the corrosive conditions usually existing in most solvent extraction plants, severe restrictions are often imposed on the choice of materials of construction. Synthetic materials such as polyvinyl chloride and reinforced polyester resins have been common in recent years, although coated mild steel and stainless steel are still common. More detailed information can be found in the literature [7.9].

### 7.3.12. Economics

The concentration of metals in solution, the value of the metal being recovered, together with the flow throughput, may singly or in combination contribute to the decision on the possible use of solvent extraction. In addition, the upstream and the downstream aspects of the overall process have to be considered, and the solvent extraction process evaluated and compared with other possible unit operations, such as precipitation and ion exchange.

Economic considerations may be divided into capital investments and operating costs, as noted briefly below. More complete details are reported in the literature [7.44, 7.54, 7.104, 7.105].

#### 7.3.12.1. Capital cost

Capital cost is primarily related to the size of the equipment necessary for a given throughput. Usually the building required to house the process is an important cost factor, as is the solvent inventory, and the ancillary equipment for the process.

#### 7.3.12.2. Operating cost

Operating costs may be divided into several areas:

- (a) Preparation of the feed solution,
- (b) Pretreatment of the solvent if required,
- (c) Scrubbing of impurities from the solvent,
- (d) Stripping reagent costs,
- (e) Solvent losses,
- (f) Labour and maintenance costs,
- (g) Loss of some of the values to the raffinate,
- (h) Power costs.

### 7.3.13. Environmental aspects

Finally, another cost factor that must be considered in the design of the solvent extraction process is that of environmental constraints. It may become mandatory to ensure that effluents entering the receiving environment contain little or no quantities of detrimental organic compounds or metal-organic species. Thus there may be the requirement to control discharges of effluents by prior treatment with activated carbon, ion exchange or by combination of various processes [7.106]. In order to develop correct water quality criteria, the biodegradability and toxicity must be determined for the solvent extraction reagents [7.54, 7.106].

## 7.4. RECOVERY OF URANIUM FROM PHOSPHORIC ACID

### 7.4.1. Introduction

Most natural phosphates contain between several tens and several hundreds of parts per million of uranium. A high percentage of the uranium in commercial phosphate rock is present as an intrinsic component of the apatite mineral lattice. When the phosphate rock is processed to produce phosphoric acid by the 'wet process' method, most of the uranium is taken into solution. The uranium obtained from phosphoric acid remains an important potential source. Only two to three years is usually required between the decision to commence operations and the startup.

As phosphoric acid is the marketable product and uranium only a by-product, the recovery of uranium must not adversely affect the quality of the phosphoric acid. This fact influences the production cost of uranium, but these production costs are not far from the costs of uranium obtained from classical ore treatment. Nevertheless, at the time of writing most of the plants recovering uranium from phosphoric acid are closed because of the low price of uranium.

Most of the uranium contained in phosphates is solubilized during the course of phosphoric acid making, using dihydrate processes. Uranium recovery varies between 85 and 90%. No particular effort has been made to improve this recovery, because of the fact that uranium recovery is not integrated into the phosphoric acid unit but only juxtaposed. Nevertheless, it is known that the use of some oxidant during phosphate leaching would improve the uranium recovery without producing any residue that would be a problem for the phosphoric acid quality.

A comprehensive study of the uranium recovery from phosphoric acid was presented in Ref. [7.107].

### 7.4.2. Processes for uranium recovery from phosphoric acid

#### 7.4.2.1. Solvent extraction processes

The 30%  $P_2O_5$  phosphoric acid produced by the 'wet process' method is a strong complexing medium for uranium. Uranium is usually present as both  $U^{4+}$  and  $U^{6+}$ . Several solvent extraction processes have been investigated and have been applied in industrial plants.

The solvent extraction of the uranium from the 30%  $P_2O_5$  acid requires a strong extractant. The strongest can extract uranium as  $U^{4+}$ . The earliest extractant, proposed around 1955 by the DOW Company [7.2], is a di-octyl pyrophosphoric acid (OPPA). This extractant, used today in the process known as the Gardinier-PUK process, was used for the first time in the 1950s and again, with some modifications, in the Gardinier phosphoric acid plant near Tampa, Florida, from 1979 to 1982.

(a) *The OPPA process.* This process, shown in Fig. 7.31, uses 3% OPPA dissolved in kerosine. Uranium and a part of the ferric iron are first reduced with powdered iron or iron chips or by electrolysis. Uranium is then extracted as  $U^{4+}$ . Uranium is stripped with hydrofluoric acid. A very impure uranium tetrafluoride is finally obtained. In the Gardinier-PUK process a second stage of dissolution of uranium tetrafluoride in nitric acid followed by TBP extraction is provided. This last stage was never applied as the impure concentrate was only accepted by converters at a high penalty.

The main disadvantage of this extractant is its chemical instability, which leads to a significant consumption of reagent. Owing to this instability, OPPA cannot be prepared far ahead of its use and the unit necessary for its synthesis must be installed near the phosphoric acid plant.

(b) *The MOPPA-DOPPA process (or Oak Ridge No. 2 process).* This process, also called the OPAP process, is described in Fig. 7.32. It uses two extractants: mono- and di-octylphenyl phosphoric acids. They are mixed together at a molar concentration of 0.3M in the diluent. Uranium is extracted as  $U^{4+}$ , which implies the same preparation as in the OPPA process. Uranium is stripped by oxidation in a 40%  $P_2O_5$  phosphoric acid. Concentrated uranium must be purified through a second cycle using a TOPO-DEHPA mixture (0.075M TOPO-0.3M DEHPA) as indicated in the next subsection.

This complex process needs two different extractant mixtures for the two circuits. It has been used for four years by the Uranium Recovery Corporation in Florida, USA, and for one year by Western Cooperative Fertilizer in Calgary, Canada. It was later replaced in the Calgary plant by the two cycle DEHPA-TOPO process.

(c) *The DEHPA-TOPO two cycle process (or Oak Ridge No. 1 process).* This process, shown in Fig. 7.33, was invented in 1969 at Oak Ridge National Laboratory (ORNL) by the Union Carbide staff [7.108-7.110]. It uses a mixture of two extractants which, separately, are weak extractants but, when used together, react as a strong extractant through a synergetic effect. These two extractants are di(2-ethyl hexyl) phosphoric acid (DEHPA) and trioctyl phosphine oxide (TOPO). DEHPA is used at a 0.5M concentration and TOPO at a 0.125M concentration in an aliphatic diluent.

In this system, uranium is extracted as  $U^{6+}$ . Therefore, in some operations, the phosphoric acid must be oxidized by air or hydrogen peroxide prior to the solvent extraction of uranium.

The DEHPA-TOPO mixture is not as strong as that of OPPA and OPAP, and the concentration ratio during the extraction stage does not exceed a factor of three. Stripping is carried out with phosphoric acid, which contains at least 30%  $P_2O_5$ , and is in the reduced state (i.e. contains  $Fe^{2+}$ ). Stripping is a difficult operation which must be carefully monitored. An inert atmosphere must be maintained in the

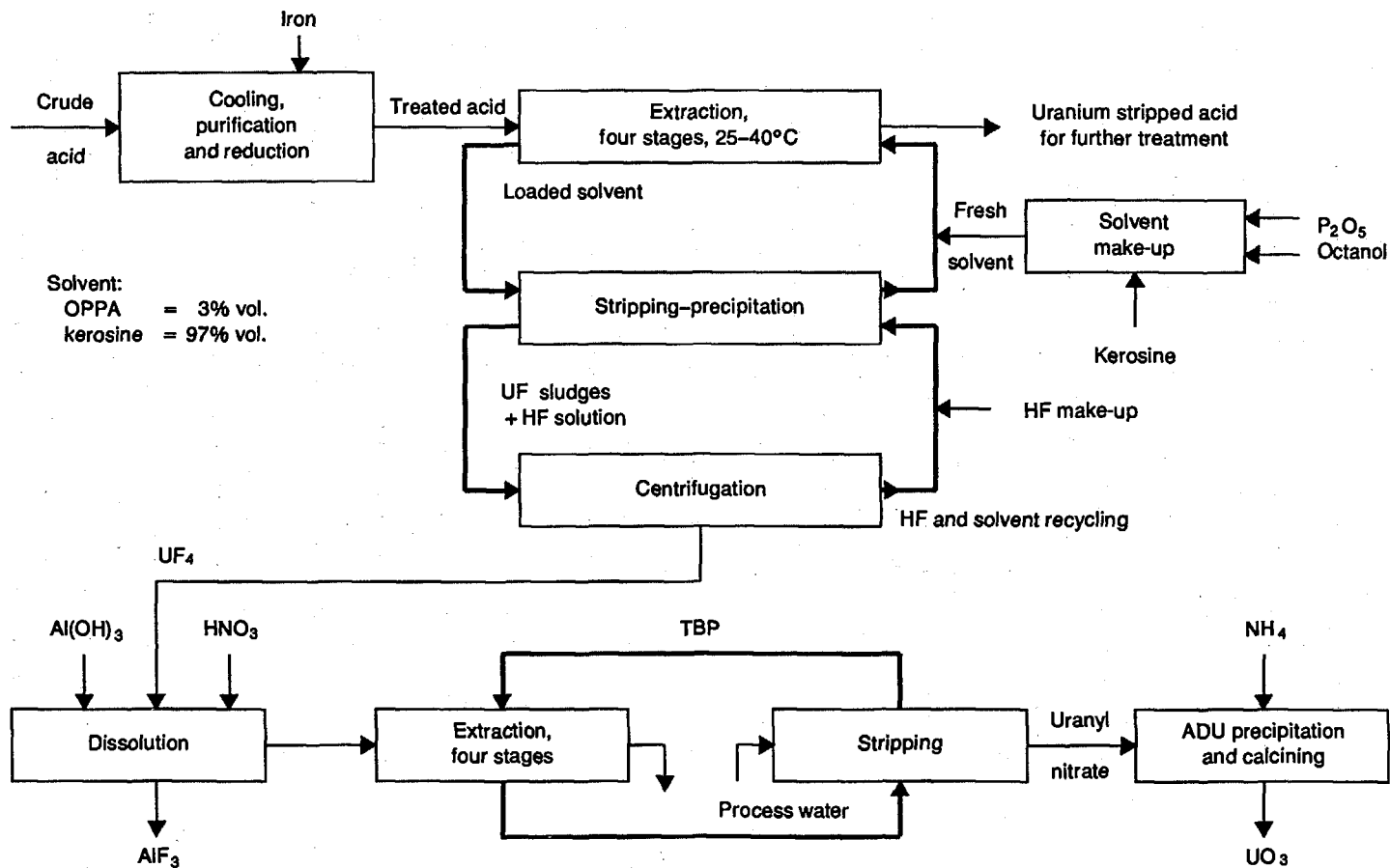

FIG. 7.31. The OPPA process.

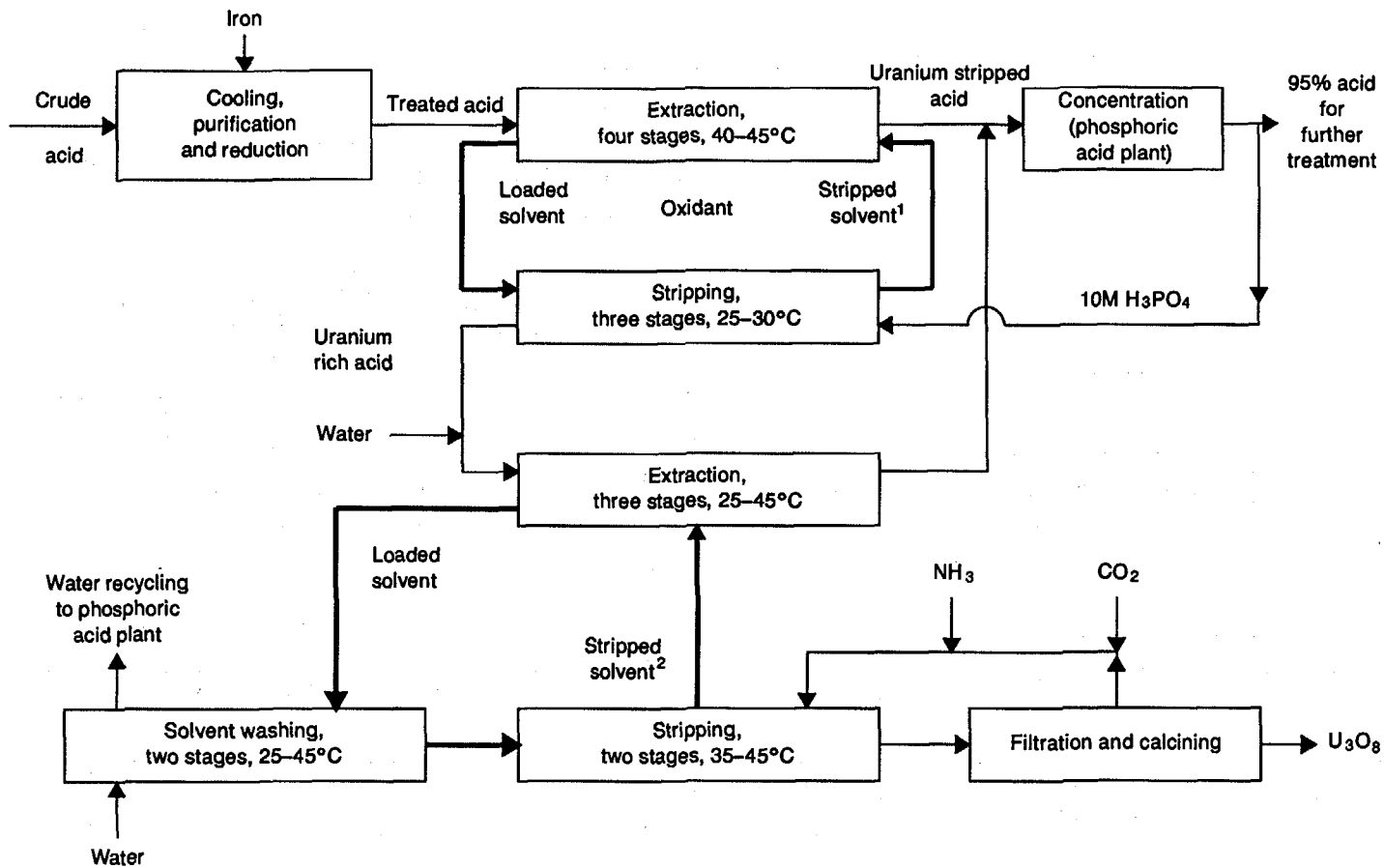

FIG. 7.32. The OPAP process. Stripped solvent 1, OPAP 0.3M in kerosine; stripped solvent 2, DEHPA 0.3M and TOPO 0.075M in hydrocarbon diluent.

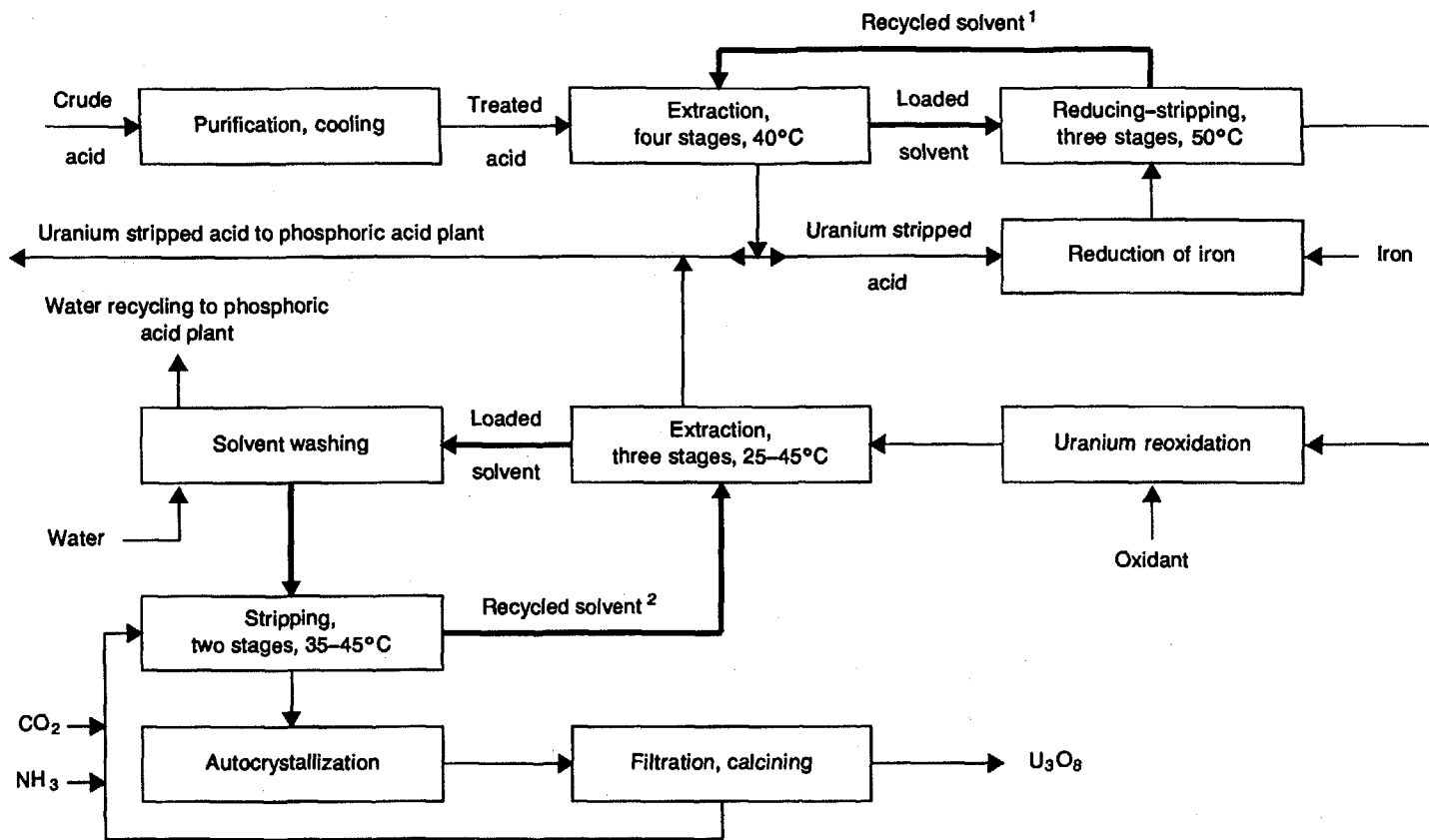

FIG. 7.33. The DEHPA-TOPO process. Recycled solvent 1, DEHPA 0.5M and TOPO 0.125M in diluent; recycled solvent 2, DEHPA 0.3M and TOPO 0.075M in diluent.

mixer settlers to avoid any oxidation of iron and, hence, of uranium. The concentration ratio after stripping is around 30 to 50. The concentration ratio during the full cycle is at least 100.

Purification is carried out through a second cycle with the same mixture. DEHPA and TOPO are again used in the same 4:1 proportion but with 0.3 and 0.075M concentrations of DEHPA and TOPO, respectively. Uranium is stripped by ammonium carbonate and crystallized as ammonium uranyl tricarbonate, which is then centrifuged and usually dried as  $U_3O_8$ .

The Prayon process, which is used in Belgium, precipitates uranium as a uranium peroxide after the ammonium carbonate stripping.

The main disadvantage of the above solvent extraction process lies in the necessity of reducing uranium, for stripping, in the first cycle. These difficulties led the researchers at ORNL to reconsider the subject [7.111]. A second difficulty is that a three phase system can form in the second stage stripping section. In addition, the iron-uranium separation can be difficult because, depending on the ratio of U to Fe, precipitation of iron hydroxide can occur.

Nevertheless, this process has been most frequently used to recover uranium from phosphoric acid. It has been applied, in particular, at the International Minerals and Chemical Company (IMC) and at Freeport Uranium Recovery Corporation in the USA. Uranium production was around 500 t of uranium per year. This process was also applied in Belgium by Prayon to produce nearly 100 t of uranium per year.

Success resulted because of

- (a) a ready supply of the two extractants, mixed at the required concentration;
- (b) the possibility of using the same extractants in the first and in the second cycle;
- (c) the chemical stability of the extractants.

The rather weak extraction strength also resulted in good selectivity.

(d) *The URPHOS processes.* From 1975 the recovery of uranium from phosphoric acid was studied at Cogema. Because of the difficulties with existing processes, it was decided to focus on:

- (1) A single cycle process,
- (2) No uranium reduction during the process.

During the initial development phase the solvent used was the classical DEHPA-TOPO mixture [7.112, 7.113]. Solvent stripping was carried out by neutralization with ammonia and ammonium carbonate. During this stripping operation iron is precipitated as iron hydroxide, which can be separated by filtration. Uranium can then be precipitated as any form of yellow cake and the solvent must be regenerated to its acid form. Uranium stripped phosphoric acid can be used for this purpose, giving finally a monoammonium phosphate.



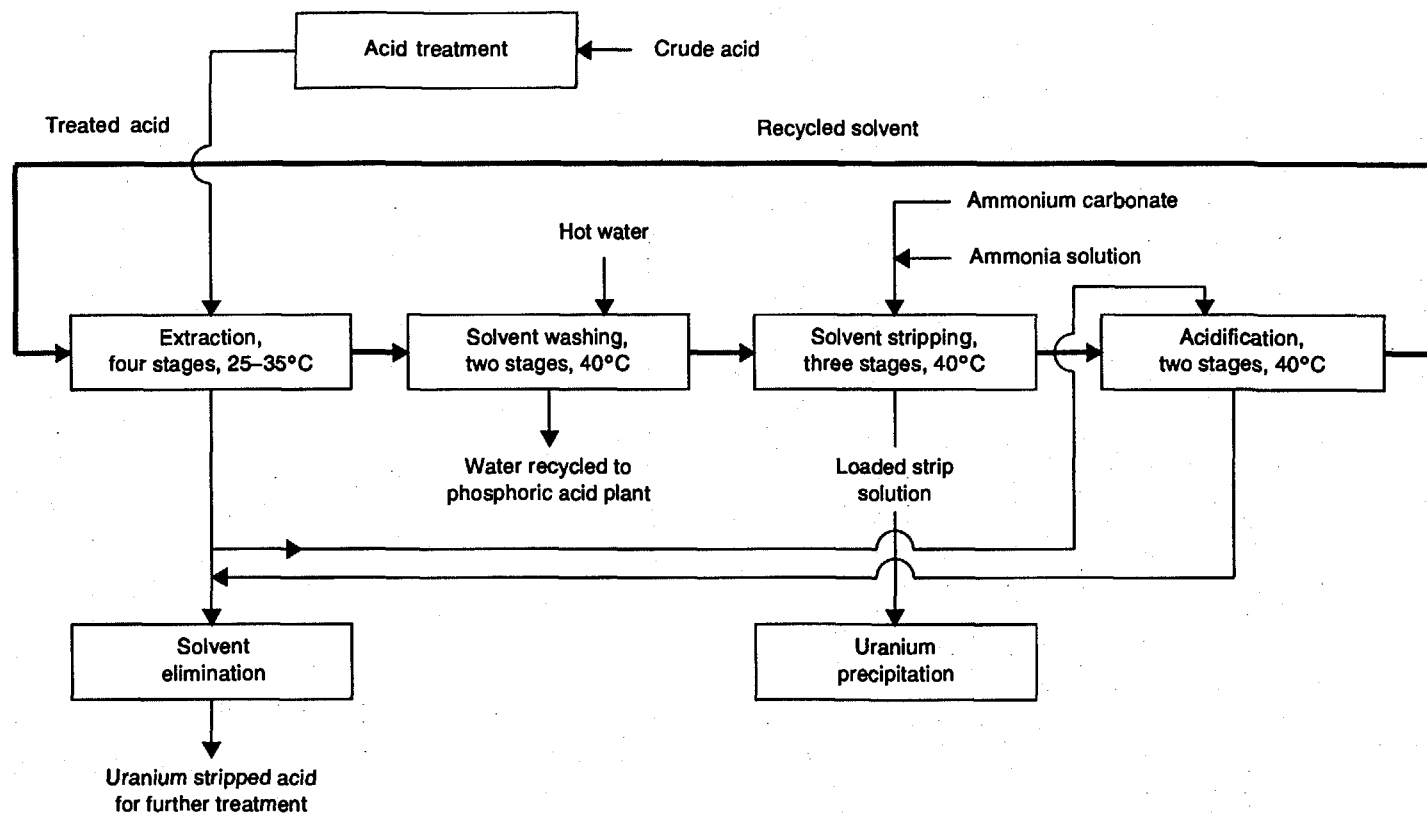

FIG. 7.34. The URPHOS process, Recycled solvent, DEHPA 0.5M and TOPO 0.125M.

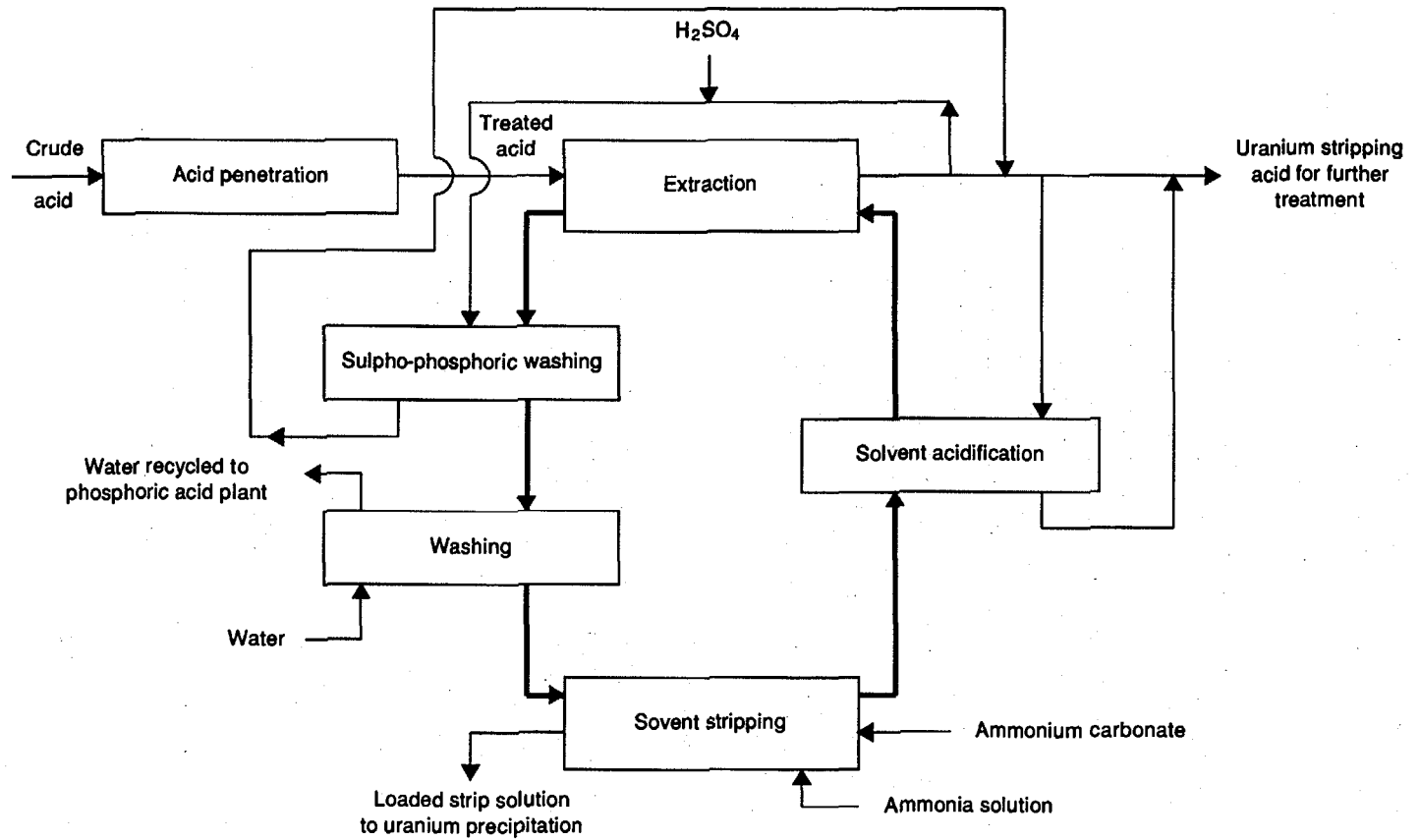

FIG. 7.35. The URPHOS No. 2 process.

This process, which is shown in Fig. 7.34, is called the URPHOS process. It was evaluated at several different scales. The final step was a pilot plant that had a phosphoric acid feed rate capacity of 1.5 m<sup>3</sup>/h. It was sited at Grand-Couronne in a phosphoric acid unit belonging to the French company Azote et Produits Chimiques.

Further progress was made when the Commissariat à l'Energie Atomique and the Institut National de Recherche Chimique Appliquée developed new extractants of the TOPO and DEHPA types [7.114–7.115]. These extractants contain ether functions in the hydrocarbon chains, and were called di-*n*-HMOPO, which is a substitute for TOPO and BIDIBOPP, which is a substitute for DEHPA.

These extractants, which are used with the same concentrations as DEHPA–TOPO, show distribution coefficients for uranium that are five times higher. The reagents are chemically stable and have a low solubility in water. However, with these extractants, the iron distribution coefficient increased. The iron concentration in the organic phase is then too high and most of this iron must be selectively eliminated before stripping. This can be carried out by washing in a two stage solvent with a mixture of sulphuric and phosphoric acids.

This new process, shown in Fig. 7.35, is known as URPHOS No. 2. Calculations of the economics show that the production costs are lower with this process than with other DEHPA–TOPO processes.

#### 7.4.2.2. Ion exchange processes

Bergeret [7.117] and Ritcey and Ashbrook [7.54] have indicated since the late 1970s that the liquid–liquid extraction process seemed a too expensive means of producing uranium. The use of ion exchange resins seems attractive for the recovery of uranium from phosphoric acid for the following reasons:

- (1) It is not necessary to cool the phosphoric acid.
- (2) Preliminary purification of phosphoric acid to eliminate solids and organic matter is not necessary.
- (3) Post-treatment is not required.

In addition, the low uranium concentration in industrial phosphoric acid solutions is more suitable for resins than for solvents. Two teams, one in France, the other in Israel, have put a considerable research effort into the ion exchange approach.

(a) *The Minemet Recherche process.* Minemet Recherche [7.118] in France used cationic chelating resins containing the hydroxy–diphosphonic groups shown below:

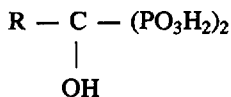

The hydroxy-diphosphonic groups were affixed to polyacrylic resins with carboxylic sites (the Duolite C 464 resin). Uranium is extracted as  $U^{4+}$ . An experiment was conducted for three weeks at the COFAZ plant near Le Havre with a phosphoric acid flow rate of 10 L/h. The resin was loaded to 3.7 g/L uranium. The resulting sodium diuranate product had the composition given in Table 7.5.

TABLE 7.5. COMPOSITION OF SODIUM DIRUANTE (%)

U	71	Fe	0.2
Na	6.6	Si	0.2
CO <sub>2</sub>	1.58	Sb	0.15
Ti	0.94	Cr	0.1
P	0.38	Cu	0.1
Ca	0.2	Pb	0.1

(b) *The Israeli process.* In Israel, Ketzinel et al. [7.119], used a cationic chelating resin with aminophosphonic groups (the Duolite ES 467 resin). Uranium was again extracted as  $U^{4+}$ .

#### 7.4.2.3. Impregnated resin processes

The impregnated resin technology is related to solvent extraction in its principles (ions are exchanged through a liquid-liquid reaction), but in this case the extractant is impregnated onto an adsorbing polymer. The major difficulty in this type of process is the high solvent loss caused by repeated washing with phosphoric acid.

In Israel, resins impregnated with DEHPA-TOPO were tested. Uranium is extracted as  $U^{6+}$  and the resins are eluted with uranium depleted phosphoric acid.

Researchers at the Imperial College of Science and Technology in London compared the results obtained from a resin impregnated by the same DEHPA-TOPO mixture with the results from a classical resin with aminophosphonic groups [7.120, 7.121]. The impregnated resin showed higher uranium loading capacities and improved uranium selectivity in the presence of calcium ions.

No commercial operations are using resins for uranium recovery from phosphoric acid at present.

#### 7.4.2.4. Other methods

Other methods are at present being investigated for the recovery of uranium from phosphoric acid. These include the possible use of either liquid membranes or froth flotation.

(a) *Liquid membrane processes.* A liquid membrane is a thin liquid film that selectively permits the passage of a particular component of a mixture. There are two types of liquid membranes: thin films supported by a solid structure and emulsions stabilized by surfactants.

The application of both types of liquid membranes to the uranium-phosphoric acid system has been studied using either DEHPA-TOPO or OPAP as extractants [7.122]. The process has been developed successfully to the stage of continuous testing at the pilot scale (60 to 150 L/h).

The advantages of liquid membranes over solvent extraction and ion exchange processes derive mainly from their more favourable kinetics. The size of the equipment is therefore smaller, and it is possible to treat phosphoric acid under more difficult conditions such as at a higher temperature (eliminating the cooling stage) and at higher acid concentrations. The process could also be applied to the recovery of uranium from hemi-hydrate acid.

An economic study was conducted on a 400 000 t/a  $P_2O_5$  equivalent phosphoric acid unit. This showed that a uranium recovery plant using a liquid membrane process would lead to a reduction in investment costs of 18% and a reduction in operating costs of 28% compared with a solvent process [7.123].

(b) *Froth flotation.* The ionic flotation technique has been applied to concentrated tetravalent uranium in phosphoric acid, because it is possible to form some floatable complexes with anionic collectors [7.124]. In this process a final precipitate with a uranium content of between 12 and 17% is produced. This product can be treated by a conventional process to obtain a commercial uranium concentrates.

## REFERENCES

- [7.1] PREUSS, A., KUNIN, R., "A general survey of types and characteristics of ion exchange resins used in uranium recovery", *Peaceful Uses of Atomic Energy* (Proc. Int. Conf. Geneva, 1955), Vol. 8, United Nations, New York (1956) 45-48.
- [7.2] PREUSS, A., KUNIN, R., "Uranium recovery by ion exchange", *Uranium Ore Processing* (CLEGG, J.W, FOLEY, D.D., Eds), Addison-Wesley, Reading, MA (1958) Ch.9, 191-236.
- [7.3] MERRITT, R.C., *Extractive Metallurgy of Uranium*, Johnson Publishing Co., Boulder, CO (1971).
- [7.4] *Separation on Ion-Exchange Resins*, Mir, Moscow (1967) 430.

- [7.5] CZEGLEDI, B., "Uranium production by ion-exchange methods", Ion Exchange Technology in the Nuclear Fuel Cycle, IAEA-TECDOC-365, Vienna (1986) 85-130.
- [7.6] KUNIN, R., Ion Exchange Resins, Robert Krieger, Melbourne, FL (1972) 504.
- [7.7] INTERNATIONAL ATOMIC ENERGY AGENCY, Manual on Laboratory Testing for Uranium Ore Processing, Technical Reports Series No. 313, IAEA, Vienna (1990) 69-85.
- [7.8] HIMSLEY, A., "Application of ion exchange to uranium recovery", Ion Exchange Technology in the Nuclear Fuel Cycle, IAEA-TECDOC-365, Vienna (1986) 53-84.
- [7.9] ARDEN, T.V., "The recovery of uranium from sulphate leach solutions by anion exchange", Extraction Metallurgy (Proc. Symp. London, 1956), IMM, London (1956).
- [7.10] DENISON MILL, Uranium oxide recovery at Consolidated Denison, Can. Min. Met. Bull. (March 1962) 175.
- [7.11] CLOETE, F.D.L., STREAT, M., UK Patent 1070251, HMSO, London, 1962.
- [7.12] CRAIG, W.M., et al., The Design and Operation of a Continuous Ion Exchange Demonstration Plant for the Recovery of Uranium (Coll. Orange Free State, 1977), South African Institute of Mining and Metallurgy, Johannesburg (1977).
- [7.13] HAINES, A.K., The development of continuous fluidized-bed ion exchange in South Africa, and its use in the recovery of uranium, J. S. Afr. Inst. Min. Metall. 78 12 (1978) 303-315.
- [7.14] NICOL, D.I., Design and operating characteristics of the NIMCIX contactor, paper presented at Ann. Conf. on Metallurgy, Can. Institute of Mining, Montreal (1978).
- [7.15] GEORGE, D.R., US Patent 3,773,889, US Commissioner of Patents, Washington, DC, 1973.
- [7.16] GEORGE, D.R., ROSENBAUM, J.B., "New developments and applications of ion exchange techniques for the mineral industry", Ion Exchange in the Process Industries (Proc. Soc. Chem. Ind. Conf., 1976), Society of Chemical Industry, London (1976).
- [7.17] TRAUT, D.E., NICHOLS, I.L., SEIDEL, D.C., Design Requirements for Uranium Ion Exchange from Ammonium Bicarbonate Solutions in a Fluidized System, RI 8280, US Bureau of Mines, Washington, DC (1978) 27.
- [7.18] TRAUT, D.E., NICHOLS, I.L., SEIDEL, D.C., Design Requirements for Uranium Ion Exchange from Acidic Solutions in a Fluidized System, RI 8282, US Bureau of Mines, Washington, DC (1978) 29.
- [7.19] HIMSLEY, A., FARKAS, E.J., "Operating and design details of a truly continuous ion exchange system", The Theory and Practice of Ion Exchange (Proc. Soc. Chem. Ind. Conf. Cambridge, 1976), Society of Chemical Industry, London (1976).
- [7.20] HIMSLEY, A., "Performance of Himsley continuous ion exchange system", Hydrometallurgy (Proc. Soc. of Chem. Ind. Symp. Manchester, 1981), Society of Chemical Industry, London (1981).
- [7.21] FORD, M.A., "The simulation and process design of NIMCIM contactors for the recovery of uranium", Ion Exchange Technology (NADEN, D., STREAT, M., Eds), Ellis Horwood, Chichester (1984) 668-678.

- [7.22] GRITTON, K.S., JEFFERS, T.H., Numerical Prediction of Cobalt Sorption in a Continuous Ion-Exchange Column, RI 9120, US Bureau of Mines, Washington, DC (1987) 13.
- [7.23] HIMSLEY, A., US Patent 4,035,292, US Commissioner of Patents, Washington, DC, 1977.
- [7.24] HIMSLEY, A., US Patent 4,018,677, US Commissioner of Patents, Washington, DC, 1977.
- [7.25] HIMSLEY, A., Recovery of uranium by ion exchange processes, Uranium Extractive Metallurgy Course, University of Toronto (1979).
- [7.26] PORTER, R.R. and ROSSING URANIUM Ltd, UK Patent 1382450, HMSO, London.
- [7.27] WYLLIE, R.J.M., Rossing uranium reaches rated production, *World Min.* **11** (1979) 52-58.
- [7.28] SLATER, M.J., Recent industrial-scale applications of continuous resin ion exchange systems, *J. Sep. Proc. Technol.* **2** 3 (1981) 2-12.
- [7.29] HIGGINS, I.R., "Update of Chem-Seps continuous ion exchange operation relations to uranium recovery", paper presented at the Uranium Mining Seminar, American Institute of Mining, Metallurgical and Petroleum Engineers, Corpus Christi, TX, 1978.
- [7.30] BROOKE, J.N., Uranium recovery from copper leaching operations, *Min. Congr. J.* **63** 8 (1977) 38-41.
- [7.31] HIMSLEY, A., "Applications of ion exchange resins and adsorbents in hydrometallurgy", *Proc. 20th Ann. Conf. of Metallurgists Hamilton*, 1981, Canadian Institute of Mining, Toronto (1981).
- [7.32] FLOTER, W.R., Uranium, *Gmelin Handbuch der Chemie*, Vol. A3, Frankfurt (1981) 5-89.
- [7.33] MERRITT, R.C., *ibid.*, p. 176.
- [7.34] IZZO, T., PAINTER, L., CHELMINSKI, R., Moab starts making  $U_3O_8$  cake, *Eng. Min. J.* **158** 1 (1957) 90-98.
- [7.35] ARGALL, G.O., How rare metals' new mill recovers  $U_3O_8$  from Arizona's painted desert, *Min. World* **9** (1956) 68-73.
- [7.36] SIMONSEN, H.A., BOYDELL, D.W., JAMES, H.E., "The impact of new technology on the economics of uranium production from low-grade ores", paper presented at 5th Int. Symp. of the Uranium Soc., London, 1980.
- [7.37] INTERNATIONAL ATOMIC ENERGY AGENCY, Significance of Mineralogy in the Development of Flowsheets for Processing Uranium Ores, Technical Reports Series No. 196, IAEA, Vienna (1980) 208.
- [7.38] INTERNATIONAL ATOMIC ENERGY AGENCY, *ibid.*, p. 64.
- [7.39] CHEMICAL ENGINEERING, New contactor unravels difficult ore, *Chem. Eng.* **66** (1959) 52.
- [7.40] SKOROVAROV, I.D., et al., "Processing of low-grade uranium ores in the USSR", Uranium Ore Processing (Proc. Advisory Group Mtg Washington, DC, 1975), IAEA, Vienna (1976) 141-153.
- [7.41] LASKOVIN, B.N., et al., A filtration-free method of processing uranium ores, *At. Ehnerg.* **43** 6 (1977) 477.

- [7.42] GASOS, P., GONZALAZ, E., OTERO DE BACARRA, J., NADAL, P., "Instalación experimental para menas de uranio alteradas", Proc. Actas 1 Congr. mediterráneo de ingeniería química Barcelona, 1978), Vol. 1, Editorial Alción, Barcelona (1978) 786-806.
- [7.43] MUSSARD, A., Innovative uranium mill makes small deposits pay, *Min. Eng.* **31** 10 (1979) 1443-1446.
- [7.44] RITCEY, G.M., SLATER, M.J., LUCAS, B.H., "A comparison of the processing and economic uranium recovery from leach slurries by continuous ion exchange or solvent extraction", *Hydrometallurgy* (Proc. Int. AIME Symp., Chicago, 1973), American Institute of Mining, Metallurgical and Petroleum Engineers, New York (1973) 419-474.
- [7.45] ROSENBAUM, J.B., ROSS, J.R., "A counter-current column for fluid-bed ion exchange of uranium slurries", *ibid.*, 535-551.
- [7.46] ARNOLD, D.R., "The development of high density ion-exchange for CIX process", Proc. 3rd Natl Mtg. of the South African Institution of Chemical Engineers, Stellenbosch, 1980, University of Stellenbosch, South Africa (1981).
- [7.47] RITCEY, G.M., *CIM Bull.* (June 1975).
- [7.48] TUNLEY, T.N., NEL, V.W., in ISEC '74, Solvent Extraction (Proc. Int. Conf. Lyon, 1974), Society of Chemical Industry, London (1974) 1519-1533.
- [7.49] CANADIAN MINING JOURNAL, *Can. Min. J.* **81** 6 (1960) 75-149.
- [7.50] HAQUE, K.E., RITCEY, G.M., LUCAS, B.H., Hydrochloric acid leaching of an Elliot Lake uranium ore, *CIM Bull.* (July 1980) 141-146.
- [7.51] CANMET, Lummus Minerals, Evaluation of Chlorine-based Processes for Uranium Ores (Contract report), DSS Rep. No. 15SQ23440-9-9130, CANMET, Ottawa (1980).
- [7.52] OTTO H. YORK COMPANY Inc., New Jersey, personal communication.
- [7.53] CLEGG, J.W., FOLEY, D.D., Uranium Ore Processing, Addison-Wesley, Reading, MA (1958).
- [7.54] RITCEY, G.M., ASHBROOK, A.W., Solvent Extraction — Principles and Applications to Process Metallurgy, Vol. 2, Elsevier, Amsterdam and New York (1979).
- [7.55] OAK RIDGE NATIONAL LABORATORY, Solvent Extraction (Proc. Mtg Gatlinburg, 1962), Oak Ridge National Laboratory, TN (1962).
- [7.56] MCKAY, H.A.C., HEALY, T.C., JENKINS, I.L., NAYLOR, A., Solvent Extraction Chemistry of Metals (Proc. Mtg Harwell, 1965), MacMillan, London (1965).
- [7.57] DYRSSEN, D., LILJENZIN, J.O., RYDBERG, J. (Eds), Solvent Extraction Chemistry (Proc. Int. Conf. Gothenburg, 1966), North-Holland, Amsterdam (1967).
- [7.58] ISEC '71, Solvent Extraction (Proc. Int. Conf. The Hague, 1971), Society of Chemical Industry, London (1971).
- [7.59] ISEC '74, Solvent Extraction (Proc. Int. Conf. Lyon, 1974), Society of Chemical Industry, London (1974).
- [7.60] ISEC '77, Solvent Extraction (Proc. Int. Conf. Toronto, 1977), Canadian Institute of Mining and Metallurgy, Montreal (1979).
- [7.61] ISEC '80, Solvent Extraction (Proc. Int. Conf. Liège, 1980), University of Liège (1980).



- [7.62] ISEC '83, Solvent Extraction (Proc. Int. Conf. Denver, 1983), American Institute of Chemical Engineers, New York (1983).
- [7.63] ISEC '86, Solvent Extraction (Proc. Int. Conf. Munich, 1986), DECHEMA, Frankfurt (1986).
- [7.64] ISEC '88, Solvent Extraction (Proc. Int. Conf. Moscow, 1988), Vernadsky Institute of Geochemistry and Analytical Chemistry of the USSR, Academy of Sciences, Moscow (1988).
- [7.65] ISEC '90, Solvent Extraction (Proc. Int. Conf. Kyoto, 1990), Elsevier, Amsterdam and New York (1990).
- [7.66] SCHWEITZER, P.A. (Ed.), Handbook of Separation Techniques for Chemical Engineers, 2nd edn, McGraw-Hill, New York (1988).
- [7.67] LO, T.C., BAIRD, M.H.I., HANSON, C. (Eds), Handbook of Solvent Extraction, Wiley, New York (1983).
- [7.68] SIALINA, E., MIGNOT, C., MICHEL, P., VIAL, J., in ISEC '77, Solvent Extraction (Proc. Int. Conf. Toronto), Canadian Institute of Mining and Metallurgy, Montreal (1979) 592-599.
- [7.69] RITCEY, G.M., "Crud in uranium solvent extraction", Mineral Processing (Proc. 14th Int. Congr. Toronto, 1982), Canadian Institute of Mining and Metallurgy (1982).
- [7.70] STAFF OF KEY LAKE MINING CORP. AND SHERRITT GORDON MINES Ltd, "The Key Lake process", paper presented at CIM Conference of Metallurgists, Halifax, 1980.
- [7.71] BELLINGHAM, A., Australas. Inst. Min. Metall. Bull. **198** (1961) 85-112.
- [7.72] RITCEY, G.M., PRICE, K.T., WONG, E.W., "Development of an Eluex process for the treatment of high chloride uranium eluates", paper presented at Ann. Canadian Uranium Producers Metallurgical Committee Mtg, Saskatoon, 1981.
- [7.73] CANMET, Energy Mines and Resources, Ottawa, unpublished data.
- [7.74] CRAIGEN, W.J.C., JOE, E.G., RITCEY, G.M., Can. Metall. Q. **9** (1970) 485-492.
- [7.75] RITCEY, G.M., LUCAS, B.H., in ISEC '74, Solvent Extraction (Proc. Int. Conf. Lyon, 1974), Society of Chemical Industry, London (1974).
- [7.76] SHELLEY, P., QUAN, C., "Performance of several new nil aromatic diluents in the recovery of copper, uranium and rare earths", ISEC '90, Solvent Extraction (Proc. Int. Conf. Kyoto, 1990), Elsevier, Amsterdam and New York (1990).
- [7.77] MANFROY, W., GUNKLER, T., in ISEC '74, Solvent Extraction (Proc. Int. Conf. Lyon, 1974), Society of Chemical Industry, London (1974) 725-745.
- [7.78] VERHAEGE, M., CLAUS, G., VAN PETEGHEM, A., VAN ACKER, P., "Diluent influence on the extraction of cobalt from chloride solutions with a tertiary amine", paper presented at AIME Ann. Mtg Dallas, TX, 1982.
- [7.79] ROBERTS, J., LYNE-SMITH, K., COLLIER, D.E., MCGEE, J., in ISEC '77, Solvent Extraction (Proc. Int. Conf. Toronto, 1977), Canadian Institute of Mining and Metallurgy, Montreal (1979) 418-428.
- [7.80] LEWIS, I.E., *ibid.*, pp. 325-332.
- [7.81] ORJANS, J.R., et al., *ibid.*, pp. 340-346.
- [7.82] BARNEA, E., *ibid.*, pp. 347-355.

- [7.83] ROBERTS, J., MCGEE, J., in ISEC '80, Solvent Extraction (Proc. Int. Conf. Liège, 1980), University of Liège (1980).
- [7.84] BARNEA, E., MIZRAHI, J., in ISEC '77, Solvent Extraction (Proc. Int. Conf. Toronto, 1977), Canadian Institute of Mining and Metallurgy, Montreal (1979) 374-384.
- [7.85] RITCEY, G.M., *J. Hydrometall.* **5** (1980) 97-107.
- [7.86] YOUNG, W., "Crud in Gulf Minerals Rabbit Lake solvent extraction circuit", paper presented at AIME Ann. Mtg New Orleans, AIME, Lakewood, CO (1979).
- [7.87] KOWALIK, T., CANTWELL, T., "Crud problems in solvent extraction and strip circuits of Conquista Uranium", *ibid.*
- [7.88] BAKSHANI, N., MAURER, E.E., ALLEN, M.P., DEGENHART, A.L., "Crud at the Sohio uranium solvent extraction circuit", *ibid.*
- [7.89] RITCEY, G.M., WONG, E.W., "Methodology for crud characterization", ISEC' 88, Solvent Extraction (Proc. Int. Conf. Moscow, 1988), Vernadsky Institute of Geochemistry and Analytical Chemistry of the USSR, Academy of Sciences, Moscow (1988) 116-119.
- [7.90] KREBS, *Technical Literature on Solvent Extraction Systems*, Krebs, Paris.
- [7.91] CASTILLON, P., GOODMAN, D., CHENEAU, G., "Industrial experience with the Krebs solvent extraction system", paper presented at Conf. of Metallurgists, CIM, Hamilton, ON, 1981.
- [7.92] SCUFFHAM, J.B., *Chem. Eng.* (July 1981) 328-330.
- [7.93] BONNEY, C.F., ROWDEN, G.A., MCKEE, D., "The combined mixer-settler — a new development in solvent extraction", paper presented at AIME Ann. Mtg Chicago, 1981.
- [7.94] ROWDEN, G.A., DILLEY, M., BONNEY, C.F., GILLETT, G.A., in *Hydrometallurgy '81* (Proc. Conf. Manchester, 1981), Society of Chemical Industry, London (1982).
- [7.95] BUHLMAN, U., in ISEC '80, Solvent Extraction (Proc. Int. Conf. Liège, 1980), University of Liège (1980).
- [7.96] DESSON, M., DUCHAMP, C., HENRY, E., JOUIN, J.P., MICHEL, P., "Utilization des colonnes pulsées dans le traitement industriel des minerais d'uranium", *Advances in Uranium Ore Processing and Recovery from Non-Conventional Resources* (Proc. Tech. Committee Mtg Vienna, 1983), IAEA, Vienna (1985) 73-81.
- [7.97] RITCEY, G.M., JOE, E.G., ASHBROOK, A.W., *Trans. Am. Inst. Min. Metall. Petrol. Eng.* **238** (1967) 330-334.
- [7.98] RITCEY, G.M., paper presented at the Society of Chemical Industry Mtg London, 1971, Society of Chemical Industry, London, 1971.
- [7.99] LUCAS, B.H., RITCEY, G.M., *CIM Bull.* (June 1975) (Canadian Patent No. 101759 (1977); US Patent 3,969,476 (1976)).
- [7.100] RITCEY, G.M., et al., "Solvent-in-pulp extraction of gold from cyanide leach slurries", ISEC '88, Solvent Extraction (Proc. Int. Conf. Moscow, 1988), Vernadsky Institute of Geochemistry and Analytical Chemistry of the USSR, Academy of Sciences, Moscow (1988).

- [7.101] WANG, J., ZHANG, R., in *Hydrometallurgy* (Proc. Symp. Manchester, 1981), Society of Chemical Industry, London (1982).
- [7.102] *Uranium Mining and Metallurgy*, Vol. 4, Atomic Energy Publishing House, Beijing (1977) 17 (in Chinese).
- [7.103] ZHANG, B.L., in Proc. ICHM'88 Manchester, 1987, Society of Chemical Industry, London (1988) 263.
- [7.104] GOW, W.A., RITCEY, G.M., The treatment of Canadian uranium ores — A review, *CIM Bull.* (Dec. 1969) 1330-1339.
- [7.105] ROBINSON, C.G., in ISEC '71, Solvent Extraction (Proc. Int. Conf. The Hague, 1971), Society of Chemical Industry, London (1971) 1416-1428.
- [7.106] RITCEY, G.M., *Tailings Management — Problems and Solutions in the Mining Industry*, Elsevier, Amsterdam and New York (1989).
- [7.107] INTERNATIONAL ATOMIC ENERGY AGENCY, The Recovery of Uranium from Phosphoric Acid (Proc. Advisory Group Mtg Vienna, 1987), IAEA-TECDOC-533, Vienna (1989).
- [7.108] LONG, R.S., ELLIS, D.A., BAILLES, R.H., "Uranium recovery from phosphate rocks using solvent extraction", *Peaceful Uses of Atomic Energy* (Proc. Int. Conf. Geneva, 1955), Vol. 8, United Nations, New York (1956) 77-80.
- [7.109] HURST, F.J., CROUSE, D.J., Reductive Stripping Process for the Recovery of Uranium from Wet-Process Phosphoric Acid, US Patent 3,711,591, US Commissioner of Patents, Washington, DC, January 1973.
- [7.110] HURST, F.J., CROUSE, D.J., Oxidative Stripping Process for the Recovery of Uranium from Wet-Process Phosphoric Acid, US Patent 3,835,214, US Commissioner of Patents, Washington, DC, September 1974.
- [7.111] HURST, F.J., CROUSE, D.J., Equilibrium and kinetic studies at the reductive stripping of uranium from DEHPA-TOPO reagent into aqueous phosphoric acid, *J. Hydrometall.* **13** (1984) 15-32.
- [7.112] COGEMA — A.P.C., Procédé d'extraction d'uranium à partir d'acide phosphorique de voie humide, Brevet français 77-20552 (1977).
- [7.113] MICHEL, P., RANGER, G., COROMPT, P., BON, P., "New process for the recovery of uranium from phosphoric acid", ISEC '80, Solvent Extraction (Proc. Int. Conf. Liège, 1980), University of Liège (1980).
- [7.114] GINISTY, C., "Improved dialkyl phosphoric acid-phosphine oxide synergistic systems for uranium recovery from phosphoric liquors", ISEC '83, Solvent Extraction (Proc. Int. Conf. Denver, 1983), American Institute of Chemical Engineers, New York (1983).
- [7.115] LYAUDET, G., TEXTORIS, A., "Nouveaux solvants pour l'extraction de l'uranium de l'acide phosphorique", paper presented at Symp. on Extraction by Solvents and Exchange of Ions, Paris, 1984.
- [7.116] BATHELLIER, A., LYAUDET, G., TEXTORIS, A., MICHEL, P., "Improved URPHOS process to extract uranium from phosphoric acid using new organophosphorous solvents", ISEC '86, Solvent Extraction (Proc. Int. Conf. Munich, 1986), DECHEMA, Frankfurt (1986).
- [7.117] BERGERET, M., "Recovery of uranium from phosphates", Proc. 4th Ann. Symp., Uranium Institute, London (1979).

- [7.118] BLANQUET, P., RICALENS, F., Synthèse des travaux de Minemet Recherche dans le domaine de l'extraction de l'uranium contenu dans l'acide phosphorique brut, *Ind. Miner. Tech.* **5** (1984) 377-388.
- [7.119] KETZINEL, Z., VOLKMAN, Y., HASSID, M., "Research on uranium recovery from phosphoric acid in Israel: progress and prospects", *Advances in Uranium Ore Processing and Recovery from Non-Conventional Resources (Proc. Tech. Committee Mtg Vienna, 1983)*, IAEA, Vienna (1985) 215-228.
- [7.120] STREAT, M., GONZALEZ-LUQUE, S., "The recovery of by-product uranium from wet process phosphoric acid solution using selective ion exchange resins", *Ion Exchange Technology (NADEN, D., STREAT, M., Eds)*, Ellis Horwood, Chichester (1984).
- [7.121] STREAT, M., GONZALEZ-LUQUE, S., Uranium sorption from phosphoric acid solutions using selective ion exchange resins, *Hydrometall.* **11** 2 (1983) 207-225.
- [7.122] NUCLEAR ENERGY AGENCY OF THE OECD, "R & D in uranium exploration techniques", *Newsl. NEA* **2** (1984) 30.
- [7.123] HAYWORTH, H.C., et al., *Sep. Sci. Technol.* **18** 6 (1983) 493-521.
- [7.124] HUWYLER, S., *Uranium Recovery from Phosphates and Phosphoric Acid*, Rep. EIR-C-1, 3rd edn, Eidgenössisches Inst. für Reaktorforschung, Würenlingen (1985).



## Chapter 8

### PRODUCT RECOVERY

#### 8.1. INTRODUCTION

The production of yellow cake is an essential step in the preparation of fuels for use in nuclear power reactors. When precipitation methods are used, not only is a high purity product required, but good filtration, settling and material handling characteristics are necessary as well as a product that can be readily dried. In North America, for example, the most commonly used method has been the use of ammonium hydroxide, and in recent years the adoption of MgO precipitation, where environmental constraints may not permit the use of ammonia. Subsequently, peroxide precipitation has begun to displace the older methods.

Precipitation may be applied directly to the leaching solution if it is sufficiently pure. However, that is rarely the case, and prior purification by either ion exchange or solvent extraction or a combination of both processes (ELUEX) may precede precipitation. Once a purified uranium solution has been obtained, either by solvent extraction or by ion exchange, the uranium product is therefore recovered by precipitation, followed by solid-liquid separation and drying. These three operations are closely linked and should be considered as components of a single system. The majority of the methods used for the final precipitation are relatively non-selective, but they are efficient procedures that produce greater than 99% recovery.

The main objective of the product recovery operation is to produce a high purity concentrate with appropriate physical characteristics, that is dense crystals that do not occlude appreciable impurities and that can be easily filtered, washed and dried. The product must also meet the specifications of the nuclear fuel industry.

#### 8.2. PRODUCT SPECIFICATIONS

The specifications for uranium concentrate are rather stringent; they are dictated by nuclear engineering considerations and by the process requirements for the production of uranium hexafluoride. For example, cadmium and boron are undesirable because they are strong neutron absorbers. Halogens are undesirable because they cause corrosion problems in the refining process. Other major impurities include thorium, iron, vanadium, zirconium, molybdenum, phosphate and sulphate. In addition, if the product results in some insoluble uranium in the subsequent nitric acid dissolution step in the refinery operation, this will not be recovered during these operations. Once solubilized in the nitric acid, the solution must be compatible with the purification solvent extraction step using TBP. Some products are not directly

TABLE 8.1. TYPICAL SPECIFICATIONS FOR URANIUM CONCENTRATES

Minimum U <sub>3</sub> O <sub>8</sub> content: 65 wt%			
Na	7.50	Halogens (Cl, Br, I)	0.25
H <sub>2</sub> O	5.00	V <sub>2</sub> O <sub>5</sub>	0.23
SO <sub>4</sub>	3.50	Rare earths	0.20
K	3.00	F	0.15
Th	2.00	Mo	0.15
Fe	1.00	As	0.10
Ca	1.00	B	0.10
Si	1.00	Extractable organic	0.10
CO <sub>3</sub>	0.50	Insoluble uranium <sup>a</sup>	0.10
Mg	0.50	Ti	0.05
Zr	0.50	<sup>226</sup> Ra	7.4 kBq/g
PO <sub>4</sub>	0.35	Maximum particle size	6.35 mm (1/4 in)

**Note:** Uranium concentrates must be of natural origin (i.e. non-irradiated), containing 0.711 wt% of the isotope <sup>235</sup>U.

<sup>a</sup> Uranium insoluble in nitric acid.

amenable and produce stable emulsions. Each converter has its own specifications, and these vary somewhat from one organization to another. There are usually two sets of specifications: one that can be accepted directly and another (somewhat less stringent) for concentrates that are accepted subject to a price penalty. A typical set of specifications is shown in Table 8.1 [8.1].

### 8.3. SOLUTION CHARACTERIZATION

Because of the specifications demanded of the product, the decision as to the type of purification steps required must be determined early in the flow sheet design. Thus, the mineralogy of the ore and the process selected will affect the type of purification as well as the type of precipitation process selected. For example, the mineralogical composition of an ore may be such that even though the chosen leach system is the least expensive, the subsequent solution purification and precipitation may be more expensive than if the more expensive leaching process had been used. That is, the integrated circuit must be designed with all the unit operations in mind. Otherwise, not only is it difficult to produce an acceptable final product, but it may be very costly as well as having an adverse environmental impact.

If the leaching solution contains levels of impurities close to the specifications, then direct precipitation from either acidic or alkaline leaching solutions may be considered. However, if high levels of thorium, zirconium, arsenic, halogens and other elements are present, then ion exchange, solvent extraction, or an ELUEX process will probably be necessary prior to precipitation. If vanadium and molybdenum are present in the final solution, then precipitation of uranium peroxide will be the most selective process for producing a specification uranium mill product.

#### 8.4. PRECIPITATION

Uranium can be precipitated from solution over a wide pH range from acidity and alkalinity, depending upon the solution type and the precipitant used. A number of different precipitants have been effective, including hydrogen peroxide, ammonia, magnesia, magnesium hydroxide and sodium hydroxide. The type of precipitating reagent chosen is influenced by factors such as:

- (a) The purity of the feed solution to the precipitation,
- (b) The product specifications demanded,
- (c) The relative reagent cost,
- (d) The possible environmental impact of the reagent.

Although precipitation has been the subject of much research, experience has shown that significant problems can be encountered in industrial practice. In some milling operations precipitation has been one of the most problematic parts of the metallurgical process. The precise conditions for precipitation are site specific and have to be optimized experimentally in each case.

Some plants experience little or no problems with precipitation and product drying and calcining. Other plants have severe problems in not only the precipitation–filtration stages, but also in the drying stage, where excessive moisture due to poor solid–liquid separation often causes problems with sticking in the dryers. The reason for the problem is often not evident.

##### 8.4.1. Precipitation testing and evaluation

Bench scale precipitation tests can be conducted with standard laboratory equipment. Normally at this scale 1 L volumes of uranium bearing solution are stirred in a beaker, and the precipitating agent is added. Parameters such as temperature, retention time, seeding, final pH value and number of stages required must be investigated. A variety of precipitating reagents should be tested.

In the laboratory the amount of uranium product that is precipitated will be insufficient to allow complete evaluation of the settling and filtration rates. However, these tests do permit the comparison of the different precipitation reagents and



precipitating variables noted above. Once the possible reagents and variables have been narrowed down and optimized, precipitation from pilot plant solutions will be necessary in order to provide a sufficient quantity of the precipitate for evaluation of the settling, washing, filtration and drying processes. Product densities and chemical specifications must be determined. Thus the most reliable design data for the subsequent plant can be determined.

It is often useful to perform thermogravimetric and differential thermal analyses to provide information about hygroscopic and bound water as well as the possible existence of volatile impurities, such as organic compounds and carbon. Such impurities may affect the settling characteristics as well as the purity. For example, at one mill there was a period of about one month when the total yellow cake production could not be settled or filtered, and therefore had to be stored in the sump until a way could be found to define the cause of the difficulty. The problem was solved by first characterizing the precipitate by a combination of chemical analysis, differential thermal analysis and thermogravimetric analysis. A method for treatment was investigated, and a modified precipitation process was developed so that the problem would not recur. The process involved a two stage precipitation, using a 'seeding' technique for recycling some of the precipitate. The settling and filtration characteristics were dramatically improved, and the mill had no further problems of that nature.

#### 8.4.2. Direct precipitation from acidic solutions

Direct double precipitation from acidic leach liquors is an alternative route to the classic precipitation process following solvent extraction or ion exchange. It can be applied in some specific cases when:

- (a) The pregnant leach solutions have a high uranium content, for example several tens of grams per litre;
- (b) The available ore reserves are too low to justify the investment required for an ion exchange or solvent extraction plant;
- (c) The product meets reasonable specifications, without significant penalties on the impurities.

Nevertheless, prior purification by ion exchange or solvent extraction is usually preferred. Direct precipitation is usually conducted in two stages.

The first stage is carried out with lime in order to precipitate iron and other impurities such as basic sulphates and hydroxides; sulphate is precipitated as calcium sulphate (gypsum). The optimum value of pH can vary according to the situation, but is usually between 3 and 4. This value of pH is a compromise between that required for uranium precipitation, which is more complete at higher pH values, and the precipitation of other elements, which is more complete at lower pH values. The iron-gypsum precipitate produced is usually separated from the liquor by filtration.

The filter cake, which contains several per cent of the processed uranium, is usually recycled to the leaching circuit. The cake can also be leached separately at a pH value below 3 and refiltered before the final discharge.

The second stage of the precipitation process can be carried out with magnesia, ammonia or hydrogen peroxide. Magnesia is commonly used. Hydrogen peroxide precipitation can be advantageous and will normally produce the highest purity concentrates.

#### 8.4.3. Direct precipitation from alkaline solutions

Leaching in an alkaline medium often leads to fairly pure liquors suitable for direct precipitation with sodium hydroxide. The operation is performed at temperatures ranging from 50 to 80°C for fairly extended periods (6–12 h). A portion of the precipitate is normally recycled to the next precipitation batch or stage in order to maximize the surface area for precipitate growth. Some 5 to 6 kg of NaOH are required for each kilogram of U<sub>3</sub>O<sub>8</sub>. In alkaline leach systems it is more important to conserve the carbonate reagent for recycling to the leaching operation than to achieve complete precipitation of the uranium. The preferred method, therefore, is to precipitate with the addition of excess sodium hydroxide according to the following reaction:

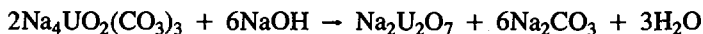

In some cases the presence of impurities in the alkaline leach solutions may not allow direct precipitation and it may be necessary to add another stage of treatment. For example, vanadium, if present in the leach solution, will co-precipitate with the uranium. To meet the product specifications the vanadium must be removed. A successful process was developed in Canada to remove the vanadium by calcining the precipitate and the subsequent water quench type of leaching solubilized the vanadium as sodium vanadate [8.2].

#### 8.4.4. Precipitation from acid stripping solutions

Hydrogen peroxide, magnesia, ammonia or ammonium hydroxide are the preferred reagents for the precipitation of uranium from acidic solutions. Peroxide precipitation is sometimes mandatory to prevent co-precipitation of other metals. Much emphasis is now being placed on avoiding the release of pollutants such as ammonia into the environment, so that peroxide precipitation is gaining in popularity.

#### 8.4.4.1. *The ammonia system*

In the ammonia system, research has shown that the precipitation reaction will take place only at certain pH levels and ammonia concentrations; also for batch precipitations a sudden drop in pH value occurs at the initiation of the reaction. Studies to relate the precipitation conditions to the thickening, filtration and drying properties have shown that changes in the precipitation conditions carried out to improve the settling and filtration characteristics can adversely affect the purity of the product. The approximate formula for the ammonium diuranate precipitate is accepted to be  $(\text{NH}_4)_2\text{U}_2\text{O}_7$ .

Precipitation with gaseous ammonia, or with ammonium hydroxide, has been widely used [8.3–8.8], but is less attractive now because of environmental considerations. The reaction for this precipitation is

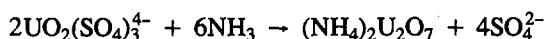

The precipitation is usually carried out using a mixture of gaseous ammonia and air at a ratio of 1:3. The temperature is held at 30 to 50°C, and the terminal pH value is between seven and eight.

Care must be taken during the precipitation of ammonium diuranate (ADU) to prevent the formation of basic uranyl sulphate, which requires only one third of the ammonia to form ADU as shown in the following equation:



The following conditions favour precipitation of the basic uranyl sulphate:

- (a) High sulphate concentration in the liquor,
- (b) Increased precipitation temperature,
- (c) Slow neutralization rate,
- (d) Low final pH value,
- (e) Long retention time.

#### 8.4.4.2. *The magnesia system*

Uranium can also be precipitated by adding milk of magnesia [8.9] to a final pH value of between 7.0 and 7.5 according to the following reaction:



where  $x$  has a value between 1 and 2.

#### 8.4.4.3. The hydrogen peroxide system

Although the ammonium diuranate product is usually of high purity, there are, nevertheless, three factors that are now beginning to influence the industry. First there is the environmental problem due to ammonia; second, product specifications are becoming more stringent; and third, lower grade ores, as well as some of the higher grade complex ores, result in higher amounts of contaminants to the process solution.

As a result the use of hydrogen peroxide as a precipitant has received considerable attention in the past few years. Uranium may be precipitated from acidic solutions with hydrogen peroxide [8.1, 8.10-8.12] as shown in the following equation:

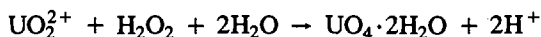

Hydrogen peroxide is added (as 70%  $\text{H}_2\text{O}_2$ ) in excess (35 to 100%) of the stoichiometric ratio at a temperature of about 25°C and a pH value of 3.5. Ammonia or sodium hydroxide are added to neutralize the acid formed (see above reaction) and maintain the desired pH value. Dilute solutions of uranium do not precipitate completely and may require a longer induction period before precipitation occurs (sometimes many hours). This method is very selective but requires careful attention.

Although there are reported data in the literature, much is nevertheless conflicting as regards the pH value of precipitation, temperature and stoichiometry of reagent addition. Research in Canada [8.13] has been directed towards determining the optimum parameters for producing the correct size of crystal for fast filtration, maximum impurity rejection and the maximum uranium recovery.

In tests the pH value was raised to 3.0 by the addition of MgO powder followed by the addition of the required amount of hydrogen peroxide. Following precipitation, standing and then filtration the filter cake was dried and analysed for U, Mg and  $\text{SO}_4$ . The particle size determinations were made with an image analysis technique.

The mean values of the statistically designed tests are given in Table 8.2, based on the treatment of 1 L of uranyl sulphate solution.

The conclusions from this research were:

- (a) The yield increased slightly as the pH value was raised.
- (b) The amount of peroxide added should be such that the molar ratio of  $\text{H}_2\text{O}_2/\text{U}$  is greater than or equal to 1.
- (c) Recoveries in excess of 95% could be expected as long as a sufficient amount of peroxide is present.
- (d) If the sulphate levels were high and the peroxide levels low, then the recovery would be decreased.

TABLE 8.2. MEAN VALUE OF RESPONSE VARIABLES

Variable	Mean
Filter cake yield (g)	23.90
Uranium precipitated (g)	14.44
Uranium content of cake (wt%)	60.41
Barren filtrate (mg/L)	2.3
Recovery (%)	98.87
Sulphur (wt%)	0.216
Mean particle size ( $\mu\text{m}$ )	8.88
Particle size distribution	0.388

- (e) The pH value of precipitation should be in the range 4 to 5.
- (f) A decrease in the peroxide concentration resulted in an increase in the sulphur content of the product. However, even at the highest sulphate levels the product would still meet the specifications of the uranium refiners.
- (g) A digestion time of about two hours should be sufficient to produce a slurry with good handling characteristics.
- (h) Time was not a particularly significant variable affecting the particle size.

#### 8.4.5. Precipitation from alkaline stripping solutions

Precipitation from alkaline stripping solutions can be carried out with sodium hydroxide [8.1] according to the following reaction:

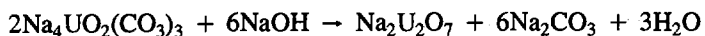

This precipitation is carried out at ambient temperature with a fairly short retention time of about two to four hours. The terminal pH value is 12. About 3 to 4 kg of NaOH are required for each kilogram of  $\text{U}_3\text{O}_8$  precipitated.

If the use of sodium hydroxide is not desirable magnesium hydroxide can be used as the precipitant. Peroxide precipitation is sometimes required to prevent co-precipitation of other metals. In this case the alkaline stripping solutions must be acidified prior to precipitation.

#### 8.4.6. Ammonium uranyl tricarbonate system

Ammonium uranyl tricarbonate (ACU) can be produced from crude uranium hydroxides, peroxides, uranates and other uranyl salts using a two stage purification procedure. The following is a contribution to this text by the Beijing Institute of Uranium Ore Processing, China [8.14]:

*Stage 1.* The uranium compounds are dissolved in a dilute ammonium carbonate solution. Uranium forms a stable uranyl tricarbonate complex,  $[\text{UO}_2(\text{CO}_3)_2]^{4-}$ , whereas most impurities form insoluble compounds that are removed by filtration.

*Stage 2.* Ammonium carbonate is added to the filtrate as a salting-out agent. Ammonium uranyl tricarbonate crystals are formed and most impurities remain in solution as soluble complexes or acidic radical anions that are separated from the AUC by filtration.

The stage 1 dissolution of uranium compounds is affected by a number of variables. These include the particle size, the period for which the compound has aged, the uranium concentration, the solid-to-liquid ratio, the initial concentration of the ammonium carbonate solution, the reaction temperature and the residence time during dissolution.

Ammonium uranyl tricarbonate can also be produced from the loaded organic phase produced during the solvent extraction (SX) of acidic leaching liquors. The following two stage procedure is used:

*Stage 1.* Uranium is stripped from the loaded organic phase with a dilute ammonium carbonate solution. After phase separation the uranium is present in the aqueous phase as a uranyl tricarbonate complex.

*Stage 2.* When ammonium carbonate is added to the aqueous phase, the uranium is salted out as AUC. If a tertiary amine is used as the uranium extractant during the SX operation, the ammonium carbonate consumption will decrease because the ammonium sulphate formed during stripping provides a common ion effect.

Some of the properties of AUC are as follows:

- (a) AUC crystals are monoclinic, with a density of  $2.830 \text{ g/cm}^3$ , and the colour is yellow green.
- (b)  $K_{sp}$  in water is  $4.9 \times 10^2$ , and the solubility is increased with increasing temperature.
- (c) Increasing concentrations of ammonia ions lead to decreasing solubility of AUC.
- (d) AUC will decompose and yield  $\text{UO}_2\text{CO}_3$  when the solution is heated.
- (e) AUC easily dissolves in mineral acids, producing uranyl ions, as indicated below for dissolution in sulphuric acid:

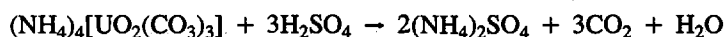

- (f) AUC is unstable in air, and slowly decomposes at room temperature. A temperature increase to 360°C yields:

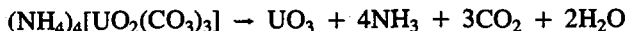

- (g) In an inert atmosphere at 600°C, AUC decomposes to  $\text{UO}_2$ .

An improved process, also developed in China [8.14], combines the stripping and precipitation stages in one step in the same piece of equipment. The operating variables include the concentration of uranium in the organic phase, the ammonium carbonate concentration, the organic:aqueous phase ratio during stripping and the temperature.

With proper operations and controls, AUC products can meet full nuclear grade specifications.

### 8.5. SOLID-LIQUID SEPARATION

After precipitation the product is dewatered by thickening or by centrifugation. It can then be sent directly to drying or, if necessary, it can be filtered and washed on drum or belt filters. In some operations filtration has proved difficult. Problems that may be encountered include: co-precipitation of impurities, excessive carry-over of solution, slimy precipitates or very fine particles. Solving these problems may involve experimenting with seeding, varying the number of stages, varying the precipitation temperature, or changing the rate of precipitation.

Depending upon the type of solution and the precipitant, and the other variables involved, some typical comparative rates of settling are shown in Table 8.3 [8.8]. The highest rate of rise of the aqueous overflow as well as the highest underflow densities were achieved with the uranium peroxide precipitate. It was noted that the relatively high underflow densities of the sodium diuranate were due to improved crystal growth, which was attained by recycling a major portion of the precipitate as seed to the precipitation.

TABLE 8.3. THICKENING OF YELLOW CAKE COMPARISONS

Measurement	Ammonium diuranate	Uranium peroxide	Sodium diuranate
Rise rate (m/h)	0.1-0.5	0.5-2.0	0.6-1.1
Underflow density (% solids)	15-30	30-50	35-40

TABLE 8.4. DEWATERING OF YELLOW CAKE

Dewatering device	Ammonium diuranate	Uranium peroxide	Sodium diuranate
Vacuum filtration			
Rate ( $\text{kg} \cdot \text{h}^{-1} \cdot \text{m}^{-2}$ )	25-125	45-1000	15-40
Cake (% solids)	30-50	40-70	30-50
Pressure filtration			
Rate ( $\text{kg} \cdot \text{h}^{-1} \cdot \text{m}^{-2}$ )	0.4-10	ND <sup>a</sup>	0.4-15
Cake (% solids)	30-65	ND	40-60
Centrifuging			
Rate ( $\text{kg} \cdot \text{h}^{-1} \cdot \text{m}^{-2}$ )	55-180	ND	95-120
Discharge (% solids)	50-75	65-75	60-70

<sup>a</sup> ND, no data.

The uranium precipitate is dewatered and washed using batch or continuous operations. Plate and frame presses are used in batch processing, while thickeners, rotary vacuum drum and disc filters, and belt filters and centrifuges are used in continuous processes. Washing may be achieved in a single stage, or in counter-current flow. The washing solutions may be, for example, dilute ammonium sulphate or process water. An adjustment of pH value may possibly be required in order to maximize the removal of the desired contaminants, as well as to minimize the redissolution of uranium.

Most mills in the USA used single stage thickening as the means to dewater the product initially, while others used two stage CCD thickening. The dewatering rates and discharge percentages of solids are shown in Table 8.4 for the three types of yellow cake produced in the USA, employing three different dewatering devices [8.8]. As in the thickening operation, dewatering is also better with the uranium peroxide precipitate, dewatering faster and producing the highest percentage of solids discharge from both vacuum and centrifuge equipment. Dewatering using centrifuges is now the most popular practice, in combination with a properly sized single stage dewatering thickener. Such a combination provides a product that is washed free of most of the entrained impurities.



TABLE 8.5. DRYING AND CALCINING

	Ammonium diuranate	Uranium peroxide
<b>Drying</b>		
Temperature (°C)	120-400	150-200
Rate ( $\text{kg} \cdot \text{h}^{-1} \cdot \text{m}^{-2}$ )	17-25	20-30
<b>Calcining</b>		
Temperature (°C)	400-850	700-800
Rate ( $\text{kg} \cdot \text{m}^{-2}$ hearth)	6-15	12-15
Retention time (h)	1.5-2.0	1.0-1.5

## 8.6. DRYING OR CALCINATION

The wet concentrate is dried or calcined and packaged in steel drums with a polyethylene liner. The ammonium diuranate product is often dried or spray dried at 150-250°C, whereas sodium diuranate is commonly calcined at about 400°C. Some operations also calcine their ammonium diuranate or hydrogen peroxide precipitated products. Calcination eliminates water completely, and drives off the ammonia, but care must be taken not to sinter the product. Sintering can significantly reduce the nitric acid solubility, which is critical for some refining processes. Several types of drying equipment have been used. These include single or multiple hearth dryers, drum dryers, belt dryers, screw dryers and radiant heat dryers.

Some typical operating ranges that have been reported for drying and calcining are given in Table 8.5 [8.8].

## 8.7. OPERATING PRACTICE FOR PRODUCT RECOVERY

The following are brief descriptions of the product recovery circuits of some selected industrial uranium operations. In industrial practice, precipitation can be carried out as a batch or continuous process in one or several stages.

### 8.7.1. Rabbit Lake

The Rabbit Lake Mill in Canada has been using precipitation with hydrogen peroxide since March 1986 [8.10, 8.11] after a decision to terminate the ammonia

process, which was considered toxic to the aquatic environment. The operation is carried out at ambient temperature in a series of four tanks. A portion of the required peroxide is added to each of the first three tanks. Magnesia, as a 10% slurry in water, is used to maintain the precipitation pH value at about 3.5. The terminal value of pH is 2.6 to 2.8. The fourth tank acts as a digestion vessel to permit crystal growth. If the peroxide was added in a single stage the result was fine: needle shaped crystals that settled slowly. The gradual addition of peroxide produced larger crystals that settled rapidly, and gave higher density underflow as well as improved centrifuge cake. The thickener underflow is 50% solids, and the centrifuge cake up to 70% solids. The uranium peroxide is washed in two thickeners and a Bird centrifuge to produce a cake.

From the precipitation reaction, the stoichiometric requirement is 0.126 kg hydrogen peroxide per kilogram of  $U_3O_8$ . However, about 1.5 times that amount is required, or 0.2 kg/kg. The higher amount was necessary for the following reasons:

- (a) Formation of soluble complexes of dissolved metals such as As, Ni, Mo and V;
- (b) Decomposition of the reagent as indicated by the following equation:  
$$2H_2O_2 \rightarrow 2H_2O + O_2;$$
- (c) Competition for uranium and other uranium complexing species such as chloride or sulphate;
- (d) Oxidation of organic compounds that may be present.

Data obtained during operation of the circuit [8.10] in the temperature range 18 to 40°C showed that:

- (1) While the precipitation temperature may be a determining factor in the product bulk density, it was not the only factor.
- (2) Higher temperature operation did not require extra hydrogen peroxide, as might have been expected from a more rapid peroxide decomposition rate.
- (3) Temperature did not significantly affect the completeness of precipitation.
- (4) Temperature had no significant effect of the level of the impurities.

A Bethlehem 'porcupine' model rotary screw dryer is used to dry the centrifuge cake to a moisture content of about 10%.

### 8.7.2. Rio Algom Panel

At the Rio Algom Panel operation in the Elliot Lake area of Canada [8.15] the product recovery process uses a strong sulphuric acid elution of the loaded ion exchange resin followed by neutralization of the excess acid with lime. Undesirable impurities are thus precipitated and removed by filtration. The precipitate filters well. The final uranium precipitation uses magnesia. A similar process had previously been used at the Port Pirie mine in Australia [8.16].

### 8.7.3. Key Lake

At the Key Lake operation in Saskatchewan [8.17] uranium is precipitated from the solvent extraction strip solution, which contains approximately 25 g/L  $U_3O_8$ , with gaseous ammonia at a pH value of between 7 and 8. The yellow cake precipitate is dewatered in a centrifuge to 60% solids and dried in a multiple hearth dryer. The dried product contains about 88%  $U_3O_8$ .

### 8.7.4. Ciudad Rodrigo

At Ciudad Rodrigo in Spain [8.18], the uranium is precipitated in a three tank continuous circuit using a 1:3 mixture of ammonia to air. The operation is carried out at 30–35°C, and the terminal pH value is 7. The concentrate is separated from the liquor by decantation, given an additional decantation wash and filtered. The yellow cake is dried in ovens at 250°C and packed in 200 L drums. The product, which is relatively homogeneous, has a  $U_3O_8$  content of 83 to 86%.

### 8.7.5. Cluff Lake

The Cluff Lake mill in Canada used a double precipitation process from 1980 to 1984, at which time the high grade ore was depleted [8.19, 8.20]. The high grade ore was upgraded by gravity concentration prior to leaching, and the pregnant liquors contained between 20 and 30 g/L  $U_3O_8$ . The first precipitation was carried out by adding lime to a pH value of 3.5. This precipitate was settled in a thickener and then filtered on a belt filter. The filter product, which was termed 'iron-gypsum cake' was leached at a pH value of 2.8 to recover the uranium [8.17]. Typical results showed that the iron-gypsum cake contained between 1 and 2% of the uranium; 75% of this uranium was recovered when the cake was leached. The final iron-gypsum cake leach residue was filtered and washed on a belt filter before being discharged to the effluent treatment section. The bulk of the uranium, which was contained in the first stage thickener overflow, was precipitated in a second stage with milk of magnesia to a pH value of 7.

The next phase in the plant was to convert to a solvent extraction purification, followed by precipitation of the uranium product from the acid stripping solution with magnesia.

### 8.7.6. Lodève

The plant at Lodève in France uses an alkaline leaching circuit. The Lodève operations are complicated by the presence of zirconium. The original process [8.9] involved the precipitation of a preconcentrate with lime followed by roasting of the

preconcentrate to destroy organic matter. The roast calcine was dissolved in a sulphuric acid solution and the uranium reprecipitated as a magnesium uranate. This yellow cake product contained undesirable quantities of zirconium and molybdenum.

A new and improved process [8.12] became operational at Lodève in 1984. This process begins with acidification of the pregnant alkaline leach liquor to a pH value of 5 with sulphuric acid at 50°C. This adjustment of pH value destroys the uranyl tricarbonate complexes, the sodium carbonate and the sodium bicarbonate. A preconcentrate is then precipitated with sodium hydroxide at a pH value of 12 and a temperature of 50°C. This preconcentrate contains the uranium, the zirconium and some organic matter. Molybdenum, sodium sulphate and the remainder of the organic matter stay in solution. The precipitate is separated by settling because filtration is almost impossible. The preconcentrate is redissolved with sulphuric acid at a pH of 3 and a temperature of 50° C. The uranium almost completely redissolves. The zirconium, which partially redissolves, hydrolyses slowly; and after four hours more than 85% of the zirconium can be removed by filtration using a very fine precoat filter. The zirconium precipitate contains a small amount of uranium that is redissolved with sulphuric acid at pH2, filtered, and recycled to the acidification step. The uranium is precipitated with hydrogen peroxide; the sulphuric acid generated by the precipitation reactions is neutralized with sodium hydroxide to maintain the pH at 3.5.

#### REFERENCES

- [8.1] INTERNATIONAL ATOMIC ENERGY AGENCY, Manual on Laboratory Testing for Uranium Ore Processing, Technical Reports Series No. 313, IAEA, Vienna (1990) 100-105.
- [8.2] RITCEY, G.M., JOE, G., HAWTREY, R.C., "Purification of sodium diuranate at the Eldorado Beaverlodge Mill", Proc. C.I.C. Symp. on Problem Solving in Chemical Engineering, Chemical Institute of Canada, Ottawa (1965).
- [8.3] CORDERO, G., "Precipitación continua, con amoniaco, de extractos acuosos de extracción de amninas", Informe R.24.66, Junta de Energía Nuclear, Madrid (1966).
- [8.4] JANOV, J., ALFREDSSON, P.G., VILKAITIS, V.K., The influence of precipitation conditions on the properties of ammonium diuranate and uranium dioxide powders, *J. Nucl. Mater.* **44** (1972) 161-174.
- [8.5] MERINO, J.J., Características de suspensiones de uranato de amonio, Informe JEN/S.T.M./R-21-76, Junta de Energía Nuclear, Madrid (1976).
- [8.6] WOOLFREY, J.J., The preparation and calcination of ammonium uranates — A literature survey, Rep. AAECITM-476, Australian Atomic Energy Commission, Sutherland (1968).
- [8.7] JOSA, J.M., "La mineralurgia del uranio en España", Uranium Ore Processing (Proc. Advisory Group Mtg Washington, DC, 1975), IAEA, Vienna (1976) 41-53.

- [8.8] LITZ, J.E., COLEMAN, R.B., "A review of United States yellow cake precipitation practice", Production of Yellow Cake and Uranium Fluorides (Proc. Advisory Group Mtg Paris, 1979), IAEA, Vienna (1980) 101-115.
- [8.9] BODU, R., et al., "L'usine de Lodève: un procédé alcalin complexe pour un minéral d'uranium complexe", Advances in Uranium Ore Processing and Recovery from Non-conventional Resources (Proc. Tech. Committee Mtg Vienna, 1983), IAEA, Vienna (1985) 131-167.
- [8.10] EDWARDS, C.R., "Hydrogen peroxide precipitation of uranium in the Rabbit Lake mill", Crystallization and Precipitation (Proc. Int. Symp. Toronto, 1987), Pergamon Press, Oxford (1987) 149-157.
- [8.11] MILDE, W.W., Rabbit Lake project — milling and metallurgy, CIM Bull. (Dec. 1989) 69-75.
- [8.12] GUIRAUDIE, R., MICHEL, P., MORET, J., RIGO, L., "Continuous precipitation of uranium peroxide at the Lodève plant", Crystallization and Precipitation (Proc. Int. Symp. Toronto, 1987), Pergamon Press, Oxford (1987) 183-189.
- [8.13] HOPKINS, J.S., GOLDING, J.A., RITCEY, G.M., The critical factors influencing uranium precipitation by hydrogen peroxide: the use of experimental design techniques, J. Hydrometall. 17 (1986).
- [8.14] XIA, DE CHANG, The production of AUC, Beijing Institute of Uranium Ore Processing, Beijing, personal communication.
- [8.15] NUCLEAR ENERGY AGENCY OF THE OECD, INTERNATIONAL ATOMIC ENERGY AGENCY, Uranium Extraction Technology: Current Practice and New Developments in Ore Processing, OECD/NEA, Paris (1983).
- [8.16] ALFREDSON, P.C., "Australian experience in the production of yellow cake and uranium fluorides", Production of Yellow Cake and Uranium Fluorides (Proc. Advisory Group Mtg Paris, 1979), IAEA, Vienna (1980) 149-171.
- [8.17] FLÖTER, W., "The acid pressure leaching process for the Key Lake project, Canada", Advances in Uranium Ore Processing and Recovery from Non-conventional Resources (Proc. Tech. Committee Mtg Vienna, 1983), IAEA, Vienna (1985) 117-130.
- [8.18] FOURNIER, P., "Milling high grade uranium ore at Cluff Lake, Saskatchewan", Proc. Mtg of Canadian Uranium Producers, Metallurgical Committee, Bancroft, Canada, 1982, Canada Centre for Mining and Energy Technology, Ottawa (1983).
- [8.19] ROWSON, J., NGUYEN, T., "Case studies of the chemical precipitation process at the Cluff Mining uranium Mill", Proc. Int. Symp. Saskatoon, Saskatchewan, 1986, Chemical Institute of Canada (1986).

## Chapter 9

### BY-PRODUCTS

#### 9.1. INTRODUCTION

Vanadium, molybdenum, copper, nickel, cobalt, arsenic, gold, the rare earths and yttrium may be locally associated with uranium ores. To a lesser extent, thorium, scandium and selenium may also be present. All of these elements, except for gold, are co-extracted with various degrees of recovery during leaching. Most of the time the concentration of these elements is too low to permit economical separation and recovery, but high enough to affect the purity of the yellow cake. Special separation steps must be included in the processing operations to ensure the required yellow cake purity.

In some instances a valuable by-product can be produced from the process liquors. Environmental considerations may also warrant the by-product recovery of an element even though the direct economics are marginal. Usually, the by-product value represents only a few per cent of the uranium value. In some cases, however, the value of an associated element may approach or even exceed that of the uranium. This relationship holds for the gold in South Africa, the copper in Australia (Olympic Dam) and the vanadium in some US operations.

The chemical salts produced during processing may also be recovered for environmental reasons. Examples include the ammonium sulphate production at Key Lake in Canada and the sodium sulphate recovery at Lodève in France.

To be generally marketable, the radioactivity and uranium levels in the by-products must be very low; sometimes the targets for these may be difficult to reach.

#### 9.2. VANADIUM

Vanadium is normally a major component of the carnotite type ores found in the western states of the USA. Past operations used salt roasting technology in combination with precipitation or ion exchange separations to produce distinct uranium and vanadium products (refer to Section 4.4). At present all the salt roasting mills are shut down.

Current technology, such as that practised at UMETCO's White Mesa Mill in Blanding, Utah, uses acid leaching followed by solvent extraction separations (refer to Chapter 17).

Vanadium has also been reported in the calcrete type ores of Africa (Namibia, Somali) and in Western Australia (Yeelirrie). All of these projects are still under study.

### 9.3. MOLYBDENUM

Molybdenum is a troublesome element that causes problems during both ion exchange and solvent extraction separations. Various techniques have been used to separate molybdenum from uranium. These include:

- (a) Selective solvent stripping with sodium chloride,
- (b) Secondary solvent extraction of the strip liquors from the uranium solvent extraction operation,
- (c) Adsorption from pregnant leach liquors or eluates by activated charcoal.

The COMINAK mill in Niger recovered molybdenum as a by-product of calcium molybdate from 1978 to 1989. The uranium leaching process uses sulphuric acid pugging followed by a sodium chlorate addition and acid curing. The cured product is repulped with water and then filtered on belt filters. The uranium is recovered from the pregnant leach solution using a solvent extraction — sodium chloride stripping — process. Before the solvent was recycled to extraction, it was regenerated with a 1.5M sodium carbonate solution, which stripped the molybdenum from the solvent. This solution was then acidified to a pH value of between 1.5 and 2 at 60°C with sulphuric acid to eliminate carbon dioxide, and calcium molybdate was precipitated by adjusting the pH value to 9 with milk of lime. The filtered and dried product contained 35 to 40% Mo and, along with other minor impurities, around 0.5 to 1% U.

The calcium molybdate product required purification. Various processes were studied, and the following one was evaluated in a pilot plant:

- (a) Sulphuric acid solubilization followed by filtration to remove calcium sulphate,
- (b) Separation of molybdenum and uranium on activated charcoal,
- (c) Elution of the molybdenum from the charcoal with an ammonia solution,
- (d) Precipitation of a purified ammonium molybdate with ammonia.

The process proved to be technically feasible, but because of market conditions at the time, no plant was constructed.

Molybdenum is also recovered in the Lodève plant of the Compagnie générale des matières nucléaires in France as molybdenum sulphide. The Lodève sedimentary ore (permian shales) contains about 0.3% U and up to 0.03% Mo. It is a complex and refractory ore that also contains:

- (1) Clayey materials (e.g. illite and montmorillonite),
- (2) Carbonate (e.g. siderite and ankerite) — between 6 to 10% expressed as CO<sub>2</sub>,
- (3) Sulphides — 0.8 to 1.0%,
- (4) Organic matter — around 1%.

The Lodève uranium leaching process uses a two stage alkaline pressure leaching process with sodium carbonate under an oxygen overpressure. The leaching

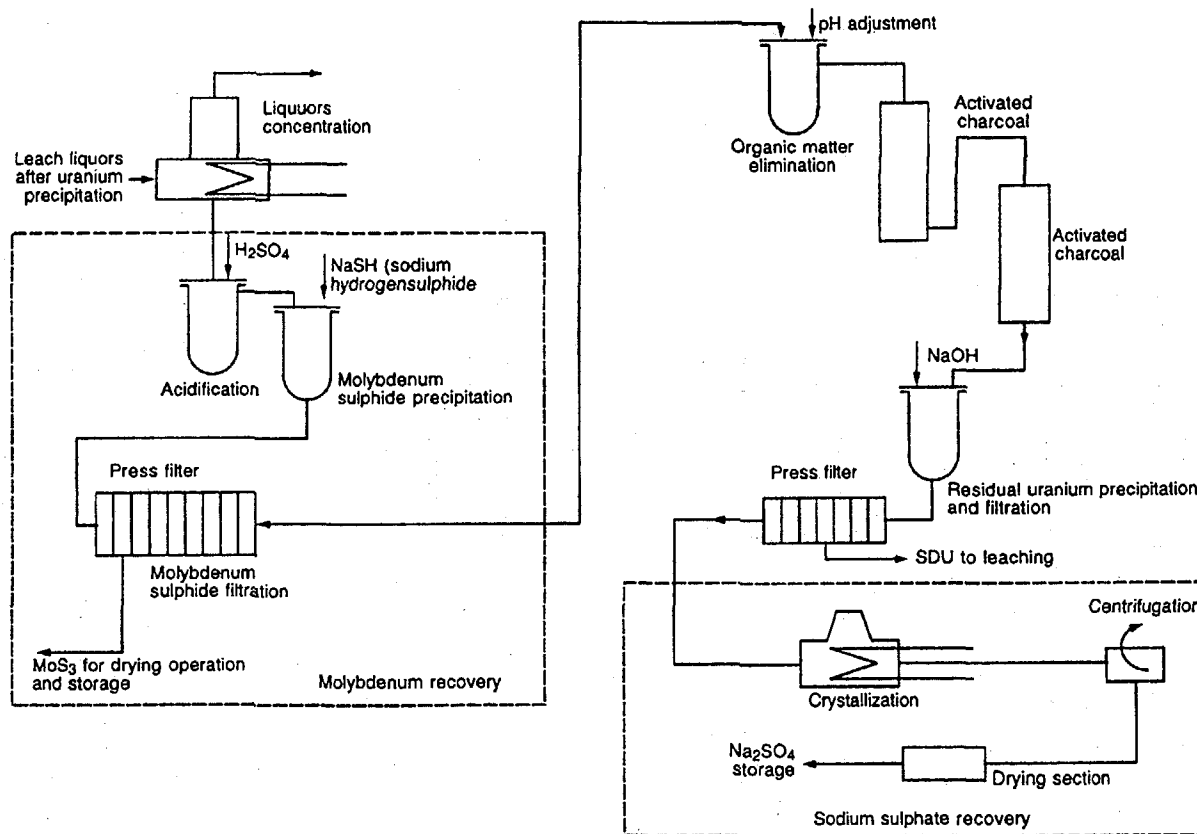

FIG. 9.1. Molybdenum and sodium sulphate recovery circuit (Lodève mill of Compagnie générale des matières nucléaires in France). SDU, sodium diuranate.



dissolves a major part of the molybdenum. The uranium is precipitated as sodium diuranate (SDU) by adding sodium hydroxide. The SDU is resolubilized by the addition of sulphuric acid, the insoluble zirconium residue is removed by filtration and the uranium is finally precipitated as uranium peroxide.

The overflow from the SDU thickener contains sodium sulphate, which is recovered by crystallization. Before this step the overflow must be treated to remove the molybdenum and organic matter. As shown in Fig. 9.1, the solution is first concentrated by evaporation, and the value of the pH is then adjusted to 2.5 with sulphuric acid to eliminate the carbon dioxide that is present. Molybdenum is precipitated as  $\text{MoS}_3$  (not  $\text{MoS}_2$ ) by adding  $\text{NaHS}$ . The reaction temperature is  $55^\circ\text{C}$ , and the retention time is two hours. The precipitate is then filtered and washed to remove most of the residual sodium sulphate. The product is relatively impure; it contains 15–30% Mo (dry basis), several per cent of sodium sulphate and 20–30% of sulphur.

At the Heng-Yang mill in China, pregnant liquors, which contain some molybdenum, are contacted with strong base anion exchange resins to recover the uranium. The uranium is eluted from the loaded resins with ammonium nitrate solutions, but this treatment does not elute the molybdenum, which can build up on the resin. To avoid this buildup the molybdenum is stripped from the resin prior to the elution of the uranium.

After a water backwash, the loaded resins are first alkalized by a 2N ammonium hydroxide solution to minimize uranium elution during the molybdenum stripping operation. The resins are then contacted with a slightly alkalized ammonium nitrate solution. This eluate is sent to another ion exchange circuit for purification and concentration. The molybdenum is first absorbed by a weak base alkaline resin, and then eluted with ammonia water. The pregnant eluate, which contains 80 to 100 g/L Mo, is precipitated by acidifying the solution. The crystallized product is a commercial grade ammonium molybdate. The ammonium sulphate produced by the process can be recovered.

#### 9.4. COPPER

Under the leaching conditions used in most uranium plants, copper is a less troublesome element than either vanadium or molybdenum. Copper can be easily separated from uranium. For example, during amine solvent extraction operations, copper is rejected to the raffinate while uranium is extracted.

Depending on the nature of the ore and the relative copper and uranium contents, the following separation techniques are applicable:

- (a) If uranium is preponderant, the ore can first be leached by sulphuric acid, and the uranium separated from the copper by solvent extraction. Copper can then be recovered from the raffinate by cementation with powdered or scrap iron.

The unleached fraction of the copper, if present as sulphide minerals, may be recovered from the leach residue by flotation.

- (b) If the copper content of the ore is appreciable, it may be feasible to produce first a copper concentrate by flotation. This concentrate can subsequently be acid leached to recover the uranium before the concentrate is smelted. The flotation tailings are acid leached, and the pregnant liquor mixed with that obtained from the copper concentrate leaching circuit. The uranium can then be separated from the copper by an amine type of solvent extraction, and the copper recovered from the raffinate by cementation. An alternative method consists of copper recovery by extraction with LIX type reagents in a conventional solvent extraction-electrowinning circuit. This process is used in the Olympic Dam operation in Australia [9.1, 9.2] (refer to Chapter 11).

### 9.5. NICKEL, COBALT AND ARSENIC

Nickel-cobalt sulphides and arsenosulphides are very often reported in the Canadian ores of the Athabasca basin. Up to 20 or 30% of the nickel, cobalt and arsenic contained in these ores is leached with the uranium. None of the mills processing the Athabasca basin ores recovers these elements as by-products. The ore grade and potential production are too low for economical recovery.

During the Key Lake project development work, studies were conducted on the recovery by flotation of the sulphide minerals from the leach residues. The development studies also investigated the recovery of arsenic as arsenic sulphide and nickel as nickel sulphide from the solvent extraction raffinates. First, arsenic sulphide was precipitated with hydrogen sulphide at an elevated temperature and pressure. Then, after modification of the pH, nickel sulphide was precipitated from the arsenic-free solution using a similar hydrogen sulphide precipitation process at elevated temperature and pressure. The nickel sulphide product contained less than 1% of cobalt.

### 9.6. GOLD (AND SILVER)

The treatment of South African ores for the recovery of uranium and gold are well documented in the technical literature [9.3, 9.4]. The following two operations are also recovering precious metals:

- (a) At the Olympic Dam operation in Australia precious metals contained in the ore are added to the copper concentrate and are recovered from the anode slimes produced in the copper electrorefining circuit. The gold and silver are extracted from the anode slimes by intensive cyanidation followed by electrorefining to produce gold bullion and silver bullion.

- (b) At the Cluff Lake (AMOK) mill in Saskatchewan, Canada, the leach residues produced from the very high grade ore (7% U) that was processed during the initial phase of the operations were stockpiled for subsequent reprocessing with lower grade feed ores. Because the gold concentration in these residues was high it appeared feasible to recover the gold before reprocessing for the uranium. For a period of over a year gold was produced using the carbon-in-pulp (CIP) process [9.5].

After processing for gold it was necessary to shift from the alkaline cyanide medium to the acidic uranium leaching system. The cyanide elimination process used, though not completely new, was quite original. The CIP tailings were first acidified with sulphuric acid in a vented tank. The solution was then sparged with air to remove the hydrogen cyanide produced by the acidification process. Finally, the off-gases were scrubbed with sodium hydroxide solution to recover the cyanide, which was recycled to the cyanidization circuit. This operation, which was recognized as being potentially dangerous, never gave rise to any problems. The atmospheric cyanide concentrations in this part of the plant and also in the uranium leaching section, which were recorded continuously, always remained below the permissible regulatory levels.

## 9.7. RARE EARTHS

The rare earths and yttrium are commonly associated with uranium and thorium minerals such as uraninite, coffinite, uranothorite, brannerite and rinkolite [9.6]. A portion of the rare earths may dissolve during sulphuric acid leaching operations. Most of the insoluble rare earths are usually associated with refractory minerals such as monazite or rinkolite. Complete recovery of the rare earths from these refractory minerals would require substantially more aggressive processing conditions than those used in conventional uranium circuits. For example, the lujavrites of the Ilimaussaq intrusion in South Greenland have been treated using a sulphating roast water leaching process [9.7]. Some rigorous leaching procedures such as pressure acid leaching, strong acid pugging-curing-water leaching and strong acid leaching have been investigated for processing rinkolite ores in China [9.8]. Rare earths can be recovered from leaching solutions by precipitation, ion exchange or solvent extraction.

At Elliot Lake in Canada [9.9], in early 1967, lime was added to the barren solution from the uranium ion exchange operation to raise the pH value to about 8.5 and produce a mixed oxide precipitate. The rare earths were leached from this precipitate by readjusting the pH value to 4.2 with acid. After clarification, a bulk precipitate containing about 30% total rare earth oxides was obtained by reprecipitation with ammonia.

In late 1967 a rare earth solvent extraction circuit, which used DEHPA as the extractant, began operations at Elliot Lake [9.10]. When the raffinate from the uranium circuit was adjusted to a pH value of 4.0–4.2 and sparged with air, the iron and thorium precipitated out. After solid–liquid separation, the clarified liquors were acidified to a somewhat lower pH value to retain the calcium in solution during the subsequent rare earth solvent extraction. The loaded DEHPA solvent was stripped with nitric acid, and the yttrium and rare earths contained in the stripping liquor were precipitated using a mixture of lime and ammonia. The product contained between 30 to 35%  $Y_2O_3$  and 60 to 70% total  $R_2O_3$  including yttrium. Because of the depressed market for the product at that time the operation was discontinued. When market conditions improved in 1986 production resumed. Concentrates containing approximately 50 t of  $Y_2O_3$  were produced in 1987; the 1988 production figure was 100 t.

Danish researchers have developed a rare earth recovery process based on the inverse solubility of rare earth and alkali metal double sulphates with increasing temperature. The rare earths precipitate when the solution obtained from leaching the sulphate roasted lujavrites with water is heated to about 80°C [9.7].

Clayey ores containing uranium, phosphorus and rare earths have been treated commercially in the former USSR [9.11]. After uranium recovery by solvent extraction, rare earths can be recovered from the uranium raffinate using either ion exchange or solvent extraction. A mixed rare earth oxide was precipitated and the final products were yttrium oxide, europium oxide and scandium oxide.

In China an SIP process has been proposed for the recovery of the rare earths obtained from the acidic pressure leaching of rinkolite ores, which contain uranium, thorium and rare earths [9.12]. In the process proposed the leach pulp is first contacted with DEHPA to extract the uranium and thorium, and then contacted with fresh DEHPA extractant to recover the rare earths. Because the rare earth concentration in the feed pulp is relatively low, impurities such as zinc, manganese, calcium and iron are co-extracted with the rare earths. The stripping solution is purified; first by amine solvent extraction and then by extraction with naphthenic acid. During the course of these extractions the impurities are removed and the rare earths concentrated. The process produces rare earth chlorides of good quality.

## 9.8. CHEMICAL SALTS

Both sodium sulphate and ammonium sulphate have been produced as by-products from commercial uranium operations. Two of these operations are described below.

### 9.8.1. Sodium sulphate

Sodium sulphate has been recovered at the Lodève mill of the Compagnie générale des matières nucléaires in France since 1980 [9.13]. During alkaline pressure leaching of the uranium under an oxygen overpressure, nearly 100% of the sulphides present in the ore are oxidized to produce sodium sulphate through reaction with sodium carbonate. After the molybdenum recovery operation, which was described in Section 9.3, the last traces of uranium are precipitated by adding sodium hydroxide to precipitate an SDU product. The SDU precipitate is recovered in a filter press. Sodium sulphate is then crystallized from the clarified solution by cooling, following which the crystals are dewatered by centrifuging. The residual moisture is removed by drying in hot air. The annual production is approximately 15 000 t/a. The sodium sulphate recovery flow sheet is shown in Fig. 9.1.

The final product, which is of very good quality, is sold to the paper industry, the glass industry and the manufacturers of washing powders.

### 9.8.2. Ammonium sulphate

Ammonium sulphate has been recovered at the Key Lake mill in Canada since operations began [9.14, 9.15].

Solvent stripping with ammonium sulphate and precipitation of the final uranium product with ammonia generate ammonium sulphate, which ultimately builds up in the circuit and, therefore, must be removed. The ammonium sulphate recovery process must be quite efficient because the regulatory limits require that the ammonia concentration in the final effluent must not exceed several tens of ppm  $\text{NH}_3$ . Originally it was intended to use the classic lime boiling technology, which produces a gypsum product that can be discarded and an ammonium hydroxide solution that can be recycled. The potential for producing and selling an ammonium sulphate fertilizer product led to the ammonium sulphate crystallization process being chosen.

The ammonium sulphate is produced from the yellow cake thickener overflow. After clarification on a precoat filter the solution is preheated in four heat exchangers and then fed to a 2 t/h quadruple effect evaporator crystallizer. The ammonium sulphate crystals are dewatered by centrifuging and then dried in a propane fired fluidized bed dryer to prepare the product for storage and shipment.

## REFERENCES

- [9.1] KENNEDY, A., Olympic dam project, *Min. Mag.* (Nov. 1988) 330-344.
- [9.2] RAGOZZINI, R.J., ROSS-SMITH, M.A., SPARROW, G.J., WALKER, G.S., Selective dissolution of uranium from a copper flotation concentrate, *J. Hydrometall.* **16** (1986) 377-393.

- [9.3] FAURE, A., et al., "Production of a high-purity uranium at a South African gold mine", Processing of Low-Grade Uranium Ores (Proc. Panel Vienna, 1966), IAEA, Vienna (1967) 119-142.
- [9.4] JAMES, H.E., "Recent trends in research and development work on the processing of uranium ore in South Africa", Uranium Ore Processing (Proc. Advisory Group Mtg, Washington, DC, 1975), IAEA, Vienna (1976) 23-37.
- [9.5] MELIS, L.A., ROWSON, J.W., Operation of a gold extraction circuit for recovery of gold from uranium tailings at Cluff Lake, Saskatchewan, CIM Bull. **82** (1989) 40-46.
- [9.6] RITCEY, G. M., ASHBROOK, A.W., Solvent Extraction, Principles and Applications to Process Metallurgy, Part II, Elsevier, Amsterdam and New York (1979) 404.
- [9.7] ASMUND, G., LUNDGAARD, T., SØRENSEN, E., "Sulphating roasting, a way to solubilize uranium in refractory minerals", The Recovery Of Uranium (Proc. Symp. São Paulo, 1970), IAEA, Vienna (1971) 185-194.
- [9.8] PENG RU QING, et al., Investigation on Leaching Uranium, Thorium and Rare Earths from Rinkolite, Beijing Research Institute of Uranium Ore Processing, Beijing, 1975, unpublished report.
- [9.9] SWIDER, R., ABRAMO, J., "The production of yttrium and rare earth concentrate at Denison Mines Ltd", paper presented at Canadian Uranium Mining Producers Congress, Elliot Lake, Ontario, 1970.
- [9.10] LUCAS, B.H., RITCEY, G.M., Examination of a rare earth solvent extraction circuit for possible upgrading of the yttrium product, CIM Bull. **68** (1975) 124-130.
- [9.11] LASKORIN, B.N. et al., Development of uranium deposits in the USSR, J. Energia **54** 4 (1983) 286-292.
- [9.12] FAN JIA JUN, et al., Investigation on Recovery of Rare Earth Chlorides from Pulp, Beijing Research Institute of Uranium Ore Processing, Beijing (1976) unpublished report.
- [9.13] DETHOOR, M., LYAUDET, G., MICHEL, P., VANHELLEPUTTE, R., "Valorization of liquid effluents by crystallization of sodium sulphate", Precipitation and Crystallization (Proc. Conf. Saskatoon, Saskatchewan, 1987), (SHATHDEE, G., Ed.), Pergamon Press, Oxford (1987).
- [9.14] CLARKE, P.J., et al., "The Key Lake uranium process", paper presented at 19th Ann. Conf. of Metallurgists of the Canadian Institute of Mining and Metallurgy, Halifax, NS, 1980.
- [9.15] MAYCOCK, A.R., NEVEN, M.G., "Design, construction, commissioning and operation of the Key Lake uranium mill", Extraction Metallurgy 1985 (Proc. Symp. London, 1985), IMM, London (1985) 43-63.



Part III

WASTE MANAGEMENT  
AND  
THE ENVIRONMENT





## Chapter 10

# TAILINGS MANAGEMENT TECHNOLOGY

### 10.1. INTRODUCTION

In many countries the mineral industry accounts for a major percentage of the gross national product. In order to recover the mineral wealth the environment must be disturbed. This means that huge quantities of rock are moved, crushed and pulverized, and processed to recover the metal, and then the bulk of this fine material is returned to the mining disposal area. These tailings constitute a large proportion of the original ore that was mined and therefore when they are disposed of they are easily visible and stand out as a potential environmental problem. The regulations that have governed the disposal of tailings through the years have continually changed and are still being modified. Thus the tailings design, disposal and close-out regulations in use only a few years ago are generally no longer acceptable as new and more stringent regulations are produced to cope with increased concerns for the eventual impact on the environment.

Tailings management has changed more than any aspect of the process. It was not a concern in the past, but now the design of the process flow sheet will have a significant effect on the ultimate cost at decommissioning. The cost of restoration of heap leaching and in situ operations must also be considered. Modifications to the process often have to be made in order to meet the environmental guidelines for discharge. Such an example is the general elimination of ammonia and nitric acid in many uranium circuits.

The remainder of this chapter has been abstracted from a textbook by G.M. Ritcey entitled, *Tailings Management: Problems and Solutions in the Mining Industry*, published by Elsevier Science Publishers, Amsterdam, in 1989.

### 10.2. TAILINGS AND WASTE ROCK CHARACTERISTICS

Tailings vary considerably in their mineral and physical characteristics and the mineral composition can have a significant influence on the chemistry that occurs within the tailings structure and therefore ultimately on the composition of the effluent leaving the tailings. The physical characteristics, such as the particle size, type of material, e.g. slimes or clay, and the porosity and permeability, will affect the water retention properties and the subsequent dewatering of the tailings to provide for both consolidation of the mass and the return of water to the plant. The mineral content of the tailings from the process, in particular sulphides, plus any

application of lime or other neutralizing agent present, will affect the ultimate composition of the tailings and the effluents, the disposal technique and the impoundment design.

Tailings from the mining and milling operation have been generally impounded with a reasonable degree of design and engineering consideration being given to provide for a site with physical stability. Waste rock has usually been considered as barren and therefore of no real concern, whereas the tailings and effluents resulting from the process were recognized as effluents and therefore of potential environmental concern. As much waste rock often contains sulphides, the weathering and oxidation and the eventual production of sulphuric acid, probably containing dissolved metals, will constitute an environmental problem to the immediate neighbourhood and the receiving waters.

### 10.3. TOXICITY OF EFFLUENTS

The discharge of waste effluents from the mining and milling complex to an impoundment area must therefore be properly planned and engineered, based on the best practical technology. Even with what is considered to be adequate design and protection there can be releases of seepage or runoff waters. Unless treated before release the dissolved constituents may affect the aquatic environment. The reagents and solutions used in a particular mill should be evaluated for toxicity effects on the aquatic life in the vicinity of the mill. In addition, although acute toxicity tests may indicate that certain reagents are toxic to certain fish that could be in the receiving environment, it is possible that such levels of concentrations do not actually leave the tailings impoundment systems because of the complex biogeochemical interactions taking place in the impoundment area, such as sorption processes which might hold or complex the substance to decrease the mobility and migration rate out into the receiving waters. Certain of the mill reagents, such as cyanides, frothers, xanthates and solvent extraction reagents, require a retention time, oxidation (air, sunlight, bacteria) and, in the case of xanthate, a temperature above 30°C to decompose. Thus the planning of the metallurgical circuit of the uranium mill must consider the environmental impact of the reagents and the possibility for the requirement for extra ponding to provide for certain reagent decomposition.

### 10.4. WASTEWATER REGULATIONS

The environmental regulations pertaining to tailings might be expected to cover the following items:

- (a) The construction of the impoundment area;
- (b) The physical stability of the disposal site;

- (c) The control of the environmental pollution of the surface water and ground-water, and the air;
- (d) The environmental effects during the mine operations of disposal and waste management, and the subsequent restoration and revegetation.

In the development of water pollution control guidelines and regulations, the approach is based on the effluent quality and on the receiving water quality standards; the main concern is for the former or 'end of pipe' standards. This requires that the mining operation be responsible for the disposal, containment and treatment of wastes 'within the fence' by applying the best practical technology while still maintaining an economic operation.

### 10.5. DESIGN OF OVERALL TREATMENT SYSTEM

In the design of the overall treatment system, the following are the four main classes of options:

- (a) Site selection,
- (b) Site preparation and design,
- (c) Physical preparation of the tailings,
- (d) Chemical preparation in the mill.

#### 10.5.1. Influence of the process

If the total plant is designed concurrently with the tailings impoundment and waste management system, taking into consideration the various chemical and physical (and possibly biological) interactions due to the influence of the mining and processing, then the tailings management problems and costs can be reduced. In addition once a plant is in operation there may be opportunities to alter the process flow sheet slightly to create a much reduced problem in the tailings impoundment.

In the mining and processing operations there are a number of possible waste discharges. These wastes could contain (depending upon the type of ore, mineralization and process) contaminants such as arsenic, nickel, manganese, molybdenum, copper, zirconium, barium, nitrate, sulphate, ammonia and radionuclides.

The following are considered to be the sources of possible contaminant migration from an operating mill or a mine: mine water; waste rock (from mining); overburden (from an open pit); tailings slurry; iron-aluminium hydroxide sludges (and arsenic); gypsum sludges; mine water; mill process waste residues; neutralized mill effluents; gaseous effluents; organic constituents (solvent extraction reagents, diesel oils, flotation agents, biological constituents, e.g. humic acids, bacteria, algae, fungi and barium-radium precipitates).

An appreciation of the 'upstream and downstream' regions of the total process is necessary if any one or more of the unit operations is to be a viable component

of the integrated plant. Some of the questions to be asked before a choice of the process route is made include the following:

- (a) What is the nature of the ore (mineralogy, values, gangue)?
- (b) Will beneficiation be viable?
- (c) Based on the mineralogy, what are the possible lixivants?
- (d) What impurities would be expected in the leaching solution?
- (e) What metal or metals are to be recovered?
- (f) What type of purification process is possible?
- (g) Are by-products possible?
- (h) What are the climatic and environmental constraints?
- (i) What are the energy requirements?
- (j) What are the corrosion problems?
- (k) What are the overall costs?

Most mining and milling operations involve the addition of several chemicals to the ore. Even in the absence of chemicals, if pyrites are present, then acid will result upon oxidation of the sulphides by air and/or bacteria. This acid can then release contaminants by leaching the tailings and waste rock. In the hydrometallurgical processing of uranium ores, various lixivants can be used, such as sulphuric acid, Caro's acid ( $\text{H}_2\text{SO}_5$ ), hydrochloric acid, nitric acid, and/or sodium carbonate and sodium bicarbonate. To decrease the environmental impact due to the process it would be an obvious advantage if the leachant could be recycled. Of course, any route that is selected must be compatible with the metallurgy of the processes used for metals recovery at minimum cost. If the total process flow sheet is to be effectively improved there must be an improved understanding of the various facets of chemistry as relating to each unit operation to achieve separation, purification and satisfactory waste disposal. These include the speciation of metals in solution, the Eh-pH relationships and the effects on separation processes and on migration of contaminants in the tailings. Optimum control will be reflected in a better understanding of the chemistry, metallurgy, biogeochemistry and engineering as applied to the process, and ultimately in the quality of the effluents discharged to the impoundment area.

#### 10.5.2. Site selection options

Each site will have advantages and disadvantages and the selection of the site must be made in combination with the mining and milling operations. The type of milling process can have a significant effect on the type of tailings impoundment area and therefore will affect the selection of the site. Such factors include:

- (a) The particular chemistry of the effluents being discharged, containing, in addition to radionuclides, dissolved metals and organic constituents;

- (b) The types of solids (including undissolved gangue, chemical precipitates and waste rock) with respect to the mineralogy and physical properties;
- (c) The biogeochemical interactions that will occur during storage in the impoundment and with weathering over time.

Site selection is also dependent upon a number of other factors, including the following:

- (1) Required storage capacity for tailings and waste rock,
- (2) Site availability,
- (3) Hydrology and hydrogeology,
- (4) Initial cost,
- (5) Ease of operations,
- (6) Geotechnical and geological conditions,
- (7) Necessity to design for a freeboard to accommodate floods occurring once every two hundred years,
- (8) Total engineering design.

Various structures have been used and proposed for tailings sites. The following are the types of impoundment areas considered: valley dam, ring dike, in pit, specially excavated pit, underground mine and deep lake or ocean. Each method will have certain advantages or constraints dictated by its choice, and the selection will have to be approved by environmental agencies. Considerable background data on the anticipated releases and possible effects on the environment are critical. Although underwater disposal has considerable merit, there has been a reluctance in the uranium industry to select such a disposal site.

## 10.6. DISPOSAL

The tailings system is comprised of many components, which include: tailings treatment in the mill, slurry thickening, slurry transport, tailings impoundment, water recycle, tailings treatment and disposal site, effluent treatment, and evaporation and restoration of the site (Fig. 10.1). The tailings and waste rock generated at the mining and milling complex can be dealt with in several ways, such as

- (a) Impoundment on land (random wet or subaqueous, subaerial, thickened discharge);
- (b) Used as a backfill material in an open pit or underground mine;
- (c) Disposal in deep lakes;
- (d) Offshore marine disposal;
- (e) Processing for secondary metal recovery and then disposal.

The present trend in uranium operations, because of the ease in dewatering the solids, is for the subaerial method, or possibly the thickened discharge method.

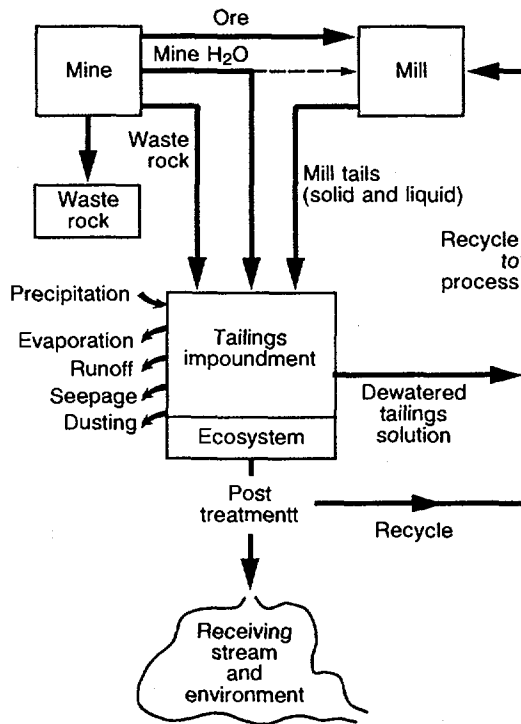

FIG. 10.1. Mining and milling tailings system.

## 10.7. WATER MANAGEMENT

Water management is of primary importance to the mining complex for the successful implementation, operation and eventual decommissioning of the site. It is also site specific.

The water control plan is concerned with:

- (a) Treatment of runoff from within the mine area;
- (b) Runoff from areas around the site and its diversion;
- (c) Diversion, collection and treatment of runoff from within the mine area.

The amount of water entering the impoundment with the tailings can be controlled, within limits, by pumping at a high slurry density, such as in the case of a thickened discharge. By proper site selection, the amount of water resulting from surface runoff can be minimized. Naturally the climate and weather have an influence on the selection of the site, as do the physical and chemical characteristics of the tailings.

### 10.7.1. Tailings ponds

A well designed tailings pond will perform a number of functions, including the following:

- (1) Sedimentation of tailings solids;
- (2) Final retention of tailings residue and precipitate sludges such as gypsum and iron bearing residues, radium-barium sulphate, other precipitates containing elements such as arsenic and base metals;
- (3) Acid neutralization, where the lime may be added at the impoundment site;
- (4) Radium removal, by addition of barium chloride, at the impoundment site;
- (5) Heavy metal precipitate formation and sedimentation;
- (6) Stabilization of constituents that require oxidation, e.g. ferrous to ferric, thiosalts to sulphate, cyanide to  $\text{CO}_2$ , and oxidation-destruction of organic reagent residuals;
- (7) Storage of seepage and runoff waters;
- (8) Balancing of influent quality and quantity;
- (9) Storage prior to recycle of quantities of water for reuse in the process.

### 10.7.2. Dewatering of tailings

When the tailings solids and solution are placed in the tailings impoundment area, the liquor will gradually separate from the solids. The water can be decanted and returned to the plant, or it may seep through the tailings. The removal (and often the recovery) of the aqueous phase from the tailings impoundment can be a very important economic aspect in most plants. In many uranium plants there is an attempt to dewater as much as possible in the mill before the discharge is made to the tailings area. This is usually accomplished by means of belt filters or pressure belt filters. At the impoundment site the tailings may be thickened before discharge into the impoundment as a thickened tailings, with the water being returned to the mill. By utilizing the optimum method for dewatering, the impoundment area requirements are decreased, recycling of the solution is increased and rehabilitation of the impoundment area is facilitated. The dewatering ability increases with increasing average particle size, decreasing amounts of fine material and lower clay content.

### 10.7.3. Water recycling and reuse

There may be various reasons why the operators of a plant would consider water recycling, but probably the most common are:

- (a) Reagent conservation;
- (b) Water conservation;



- (c) Minimization of volume of effluent discharge and therefore of the holding pond area, and the requirement for treatment;
- (d) Necessity of meeting possible zero discharge requirements of the plant operating permit.

In general, the three quality criteria that must be met before reusing or recycling water are:

- (1) After use the contaminants remaining in the water must be compatible with the requirements of the uranium process in which it is to be used.
- (2) The water should not be corrosive or form scales in piping on recycling.
- (3) The treatment that may be applied should not increase the amount of dissolved solids.

In many plants throughout the world, partial or almost complete water recycling is practised. The balance is lost to seepage or to evaporation.

#### 10.8. WEATHERING AND MIGRATION

The weathering process will be governed by precipitation (often acid rain), sunlight, temperature and humidity changes occurring during drying out, floods, snowfalls, freezes and thaws, together with the effect of the presence of bacteria. The resulting chemical interactions occurring over a period of time cause many changes in the chemical and physical characteristics of the tailings. While the mining and milling complex is operating the weathering and resulting seepage from a tailings area will be related not only to the mineralogy of the tailings but also to the particular solution chemistry of the process and the resulting waste liquors that are disposed of in the tailings.

Upon close-out the weathering process, although unchanged externally, may be considerably different within the tailings impoundment area. The interaction of the minerals with the permeating solution may cause quite different types of precipitation, sorption and redissolution as the solution passes through and out of the tailings. The results may be increased or decreased porosity and permeability, and increased or decreased dissolution of potential contaminants in the water as it leaves the tailings as seepage or runoff and arrives in the surrounding environment. The rate of leaching of the radionuclides and other contaminants will change with time and be dependent upon the hydrogeochemistry of the tailings, surrounding rock and waste rock, unconsolidated sediments and the integrity of the tailings retaining structure. The geographical location of the tailings will be a factor in the weathering process. In addition, the influence of the global cycles on weathering can be profound. These include the cycles of oxygen, carbon dioxide, nitrogen and sulphur. Interactions between the gases, minerals and pure water will strongly influence the weathering process.

The tailings pond may contain dissolved metals, radionuclides, toxic anions and organic constituents. The interaction of the tailings, because of their particular mineralogy, with the surface water involves geochemical factors relative to the kinetics of reaction, and the sorption or the desorption from sediments. These rates affect the transport through the tailings and ultimately affect the rate of biological uptake in plants on or near the tailings area. The rate of migration to the receiving environment varies with each constituent and is dependent upon many biochemical factors and interactions. The geochemical processes are complex and dynamic; some remove contaminants while others exchange one contaminant for another. The extent of migration of the mobile contaminants is dependent on the permeability of the strata underlying the tailings pond and the potential sorption or precipitation processes which may fix these contaminants in the geological strata.

### 10.8.1. Dissolution, precipitation and exchange processes

The weathering zone will be dictated by the amount of oxygen present and, in particular, the amount of water. The optimum conditions for oxidation take place in the moist material above the saturated zone. Oxidizable elements include U, Fe, Mn, S, C, N, V, Cr, Cu, As, Se, Mo, Pd, Sn, Sb, W, Pt, Hg and Co. Microorganisms also contribute to a great extent to the chemical weathering process and this is particularly evident in the presence of sulphides, which are oxidized to sulphates and sulphuric acid, and when nitrogen fixation by bacteria occurs.

As weathering proceeds, salts are formed or are being dissolved. Dissolution of the soluble salts will provide:

- (a) Heat, generated by the exothermic reaction;
- (b) Interstitial water of high ionic strength;
- (c) A source of ions to change the equilibrium by ion competition and ion complexation.

## 10.9. EFFLUENT TREATMENT

The following is an indication of the major characteristics of industrial wastewaters that will affect the quality of the receiving water, and which may have to be treated by an in-plant process: organic matter, alkalinity, acidity, suspended solids, toxic materials, colour and volatile organics.

There are many treatment processes available, and those most suited to the chemistry and biogeochemistry of the system must be selected. Three types of treatment are listed below:

- (a) Mine water — removal of values and/or contaminants by ion exchange, precipitation, etc.

- (b) Tailings slurry — lime neutralization, and the addition of barium chloride to precipitate out the radium as a mixed barium–radium sulphate. In addition, ion exchange can be used, in the mill, to remove the radium before the discharge of the effluent. The presence of arsenic in the effluent may require the removal by precipitation with lime and iron to form a ferric arsenate precipitate.
- (c) Effluent seepage and/or runoff — various treatment methods, for example ion exchange, sorption, precipitation, reverse osmosis, biological processes and ecologically engineered processes, including wetlands.

While active treatment processes may be used to advantage during the life of the operation, more permanent solutions are desirable after the mining and milling centre ceases operation.

The treatment of solutions from mining and milling wastes may be accomplished by treatment before placement, treatment during and after placement, and treatment of the final effluent.

Because of the complexity of the problem, which is often site specific in nature, those responsible for each type of operation must conduct a feasibility study of possible in-plant treatment processes.

For high quality purification, the pretreatment unit processes for uranium operations include the following:

- (1) Coagulant and polyelectrolyte addition, as in the case of producing a faster settling barium–radium sludge;
- (2) Sedimentation of leach residues and precipitates such as iron–arsenic–gypsum;
- (3) Neutralization of final mill discharge effluents to the tailings impoundment;
- (4) Sand filtration, which is used in particular for clarifying and removing suspended particles of radium–barium precipitate from the final effluents before being discharged from the last pond;
- (5) Carbon filtration, settling, in-line filters, coalescers or centrifuges may be necessary to remove large quantities of organic material that could be a result of a poorly run solvent extraction operation;
- (6) Cation, anion or mixed bed ion exchange may be required to remove certain constituents;
- (7) Precipitation may be required for certain noxious materials;
- (8) Biological treatment and ponding may be required to oxidize certain organics and thiosalts.

#### 10.10. DECOMMISSIONING, RECLAMATION AND COVERS

The objectives of restoration include the following:

- (a) Stabilization of the surface to prevent wind and water erosion;

- (b) Provision of a cover to prevent or inhibit releases of contaminants (e.g. radon gas, radionuclides, sulphuric acid and metals);
- (c) Provision of an aesthetic appearance.

Various types of cover are possible but not very many are practical in achieving all of the above objectives. These covers are:

- (1) *Vegetative* — growth of plants on tailings;
- (2) *Physical* — covering with soil, rock or other restraining material;
- (3) *Chemical* — use of material to interact with fine sized minerals to form a crust.

The costs per unit area will vary with the type of tailings, the disposal method, the location and the climatic conditions with respect to weathering.

#### 10.11. MONITORING OF TAILINGS IMPOUNDMENT SITES

In addition to the general monitoring of the tailings impoundment for seepage, breaks in the pipeline and stability of the dam, environmental monitoring must also be performed. A well designed environmental monitoring programme will determine:

- (a) Present levels of toxicants in the effluents;
- (b) Response of the environment to those effluents at the mine site and at various locations away from the point of discharge;
- (c) Pollution abatement measures necessary to comply with the standards.

The common parameters examined will include:

- (1) Dissolved solids,
- (2) Suspended solids,
- (3) Dissolved oxygen,
- (4) Temperature,
- (5) Biochemical oxygen demand,
- (6) pH value,
- (7) Conductivity,
- (8) Cations and anions.

The particular mineralogy and the process conditions will, of course, dictate the specific requirements for chemical monitoring, as well as the biological monitoring.

#### 10.12. CORPORATE RESPONSIBILITY AND ONGOING RESEARCH

Every mining operation has a corporate responsibility for providing a safe environment and suitable rehabilitation. Ideally this must be done while the company is in existence. Ongoing research must be directed in many areas towards improving

the plant process, tailings disposal and effluent treatment technologies. Once a proper understanding is achieved of the impact of the tailings due to its mineralogy and weathering, then the 'best practical technology' can be implemented to provide for the optimization of the process with respect to economic recovery while still satisfying the environmental constraints.

### 10.13 THE MODEL

The tailings — its problems and therefore its management — is only part of an overall integrated metallurgical treatment system. In attempting to understand the ultimate impact of tailings on the environment 'downstream', the relationship between the materials entering the process 'upstream' and eventually entering the tailings impoundment area must be known. Once a scientific and technical understanding of this 'total process' has been achieved, then the model that is derived can

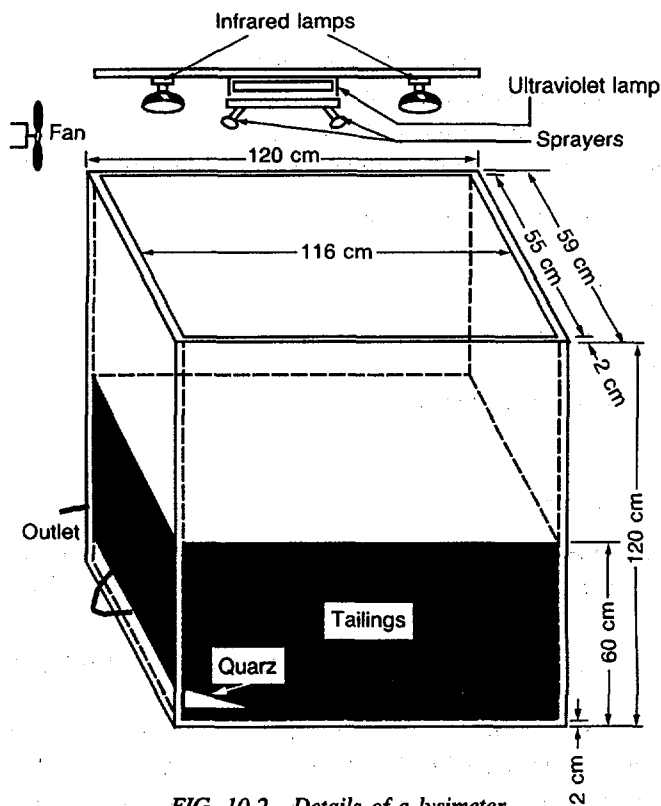

FIG. 10.2. Details of a lysimeter.

be ultimately applied to the amelioration of existing tailings environmental problems and eventually assist in the optimum design of new tailings management systems. Past (abandoned sites), present and future operations have to be considered in the modelling.

G.M. Ritcey has established a very useful testing and research procedure to assess the material going into the tailings area for long term weathering effects. This procedure, in which a simulated disposal is performed under accelerated weathering conditions, is known as a lysimeter investigation. By performing a number of inexpensive tests in lysimeters information can be obtained for the impoundment design, disposal type, vegetation and rehabilitation. A typical lysimeter design is shown in Fig. 10.2.

### SELECTED BIBLIOGRAPHY

#### Toxicity of effluents

DAVE, G., ANDERSON, K., BERGLIND, R., HASSELROT, B., Toxicity of eight solvent extraction chemicals and of cadmium to water fleas (*Daphnia magna*), rainbow trout (*Salmo gairdneri*), and zebrafish (*Brachydanio rerio*), *Comp. Biochem. Physiol.* **69C** (1981) 83-98.

DAVE, G., LINDMAN, U., Biological and toxicological effects of solvent extraction chemicals — Range finding acute toxicity in the rainbow trout (*Salmo gairdneri* Rich.) and in the rat (*Rattus norvegicus* L.), *J. Hydrometall.* **3** (1978) 201-216.

HAWLEY, J.R., The Use, Characteristics and Toxicity of Mine/Mill Reagents in the Province of Ontario, Ontario Ministry of the Environment, Toronto (1974).

RITCEY, G.M., ASHBROOK, A.W., Solvent Extraction — Principles and Applications to Process Metallurgy, Parts I, II, Elsevier, Amsterdam and New York (1984, 1979).

RITCEY, G.M., LUCAS, B.H., ASHBROOK, A.W., "Treatment of solvent extraction raffinates for the removal of organic reagents", ISEC '74, Solvent Extraction (Proc. Int. Conf. Lyon, 1974), Society of Chemical Industry, London (1974) 943-968.

— "Some comments on the loss, and environmental effects of solvent extraction reagents used in metallurgical processing", *ibid.*, pp. 2873-2884.

#### Development of waste water regulations and guidelines

EDGEWORTH, L., CORNWALL, G.M., SCOTT, J.S., "Federal waste water controls for the mining industry in Canada", Commonwealth Mining and Metallurgical Congr. Hong Kong, 1978 (JONES, M.J., Ed.), IMM, London (1978) 413-420.

ONTARIO MINISTRY OF THE ENVIRONMENT, Effluent Guidelines and Receiving Water Quality Objectives for the Mining Industry in Ontario, Ontario Ministry of the Environment, Toronto (1973).

SCOTT, J.S., The development of national waste water regulations and guidelines for the mining industry, *CIM Bull.* **67** (1974) 39-43.

### **Design of overall treatment system**

FULTON, E.J., "Caro's acid — Its introduction to uranium acid leaching in Australia", *Proc. Australasian IMM Conf. Darwin, 1984*, IMM, Parkville, Victoria, Australia (1984) 161-166.

GOW, W.A., RITCEY, G.M., The treatment of Canadian ores — A review, *CIM Bull.* **62** (1969) 1330-1339.

HAINES, A.K., The development of continuous fluid bed ion exchange in South Africa and its use in recovery of uranium, *J. S. Afr. Inst. Min. Metall.* **78** 12 (1978) 303-315.

HAQUE, K.E., LUCAS, B.H., RITCEY, G.M., Hydrochloric acid leaching of an Elliot Lake uranium ore, *CIM Bull.* **73** (1980) 141-147.

HIMSLEY, A., "Production of pure yellow cake by ion-exchange processes employing sulphate elution", *Production of Yellow Cake and Uranium Fluorides (Proc. IAEA Advisory Group Mtg Paris, 1979)*, IAEA, Vienna (1980) 51-60.

RAICEVIC, D., Decontamination of Elliot Lake uranium tailings, *CIM Bull.* **72** (1979) 109-115.

RITCEY, G.M., Crud in solvent extraction processing — A review of causes and treatment, *J. Hydrometall.* **5** (1980) 97-107.

— "Uranium flowsheets in the future", *Canadian Uranium Producers' Metallurgical Committee Mtg Toronto, 1983*, CANMET Rep. ERP/MSL 84-53(TR), Dept. of Energy, Mines and Resources, Ottawa (1984).

— "Hydrometallurgy — Its development and future", paper presented at the 1st Int. Separation Science Symp., American Chemical Society, New York (1986).

— "The process and the environment — Is solvent extraction the answer?", *ISEC '86, Solvent Extraction (Proc. Int. Conf. Munich, 1986)*, Vol. 1, DECHEMA, Frankfurt (1986) 51-66.

RITCEY, G.M., WONG, E.W., Influence of cations on crud formation in uranium circuits, *J. Hydrometall.* **15** (1985) 55-61.

RYON, A.D., HURST, J., SEELEY, F.G., Nitric Acid Leaching of Radium and Other Significant Radionuclides from Uranium Ores and Tailings, Rep. ORNL/TM-5944, Oak Ridge National Laboratory, TN (1977).

SKEAFF, J.M., LALBERTE, J.J., Continuous High Temperature Chlorination of Uranium Ores, paper presented at the AIChE Mtg, Portland, OR, 1980, CANMET Rep. ERP/MSL 80-40 (OP), Dept. of Energy, Mines and Resources, Ottawa (1980).

BRAWNER, C.O., CAMPBELL, D.B., "The tailings structure and its characteristics — A soil engineer's viewpoint", *Tailing Disposal Today (ALPIN, C.L., ARGALL, G.O., Eds)*, Miller Freeman, San Francisco (1973) 59-101.

BURKE, H.H., "Structural characteristics resulting from construction methods", *ibid.*, pp. 211-223.

CLARIDGE, F.B., NICHOLS, R.S., STEWART, A.F., Mine waste dumps constructed in mountain valleys, *CIM Bull.* 79 (1986) 79-87.

DEPARTMENT OF ENERGY, MINES AND RESOURCES, The Pit Slope Manual, Vols 1-10, Dept. of Energy, Mines and Resources, Ottawa (1977).

DOWN, C.G., STOCKS, J., Methods of tailings disposal, *Min. Mag.* 136 (1977) 345-359.

GARGA, V.K., SMITH, H.R., SCHARER, J.M., "Abandonment of acid generating mine tailings", PAN AM '83, Soil Mechanics and Foundation Engineering (Proc. 7th Pan-American Conf.), Engineering Institute of Canada, Montreal (1983) 613-626.

GOLDER ASSOCIATES, Evaluation of Flexible Membrane Liners as Long-Term Barriers for Uranium Mill Tailings, Phase I, Contract Rep. No. NUTP OSQ83-00279 to CANMET, Vols 1, 2, Dept. of Energy, Mines and Resources, Ottawa (1984).

ROBERTSON, A.M., BAMBERG, S.A., LANGE, G., "Current uranium mill waste disposal concepts: A multinational viewpoint", Uranium Mill Tailings Management (Proc. Symp. Fort Collins, 1978), Colorado State University, Fort Collins, CO (1978).

ROBERTSON, A.M., SHEPHERD, T.A., VAN ZYL, D., "Uranium tailings impoundment site selection", Uranium Mill Tailings Management (Proc. Symp. Fort Collins, 1980), Colorado State University, Fort Collins, CO (1980).

ROBERTSON, A.M., VAN ZYL, D., "Design and construction options for surface uranium tailings impoundments", Uranium Mine Waste Disposal (Proc. 1st Int. Conf. Vancouver, 1980) (BRAWNER, C.O., Ed.), Society of Mining Engineers of the AIME, New York (1980).

## Disposal

BARTLETT, C.L., VAN ZYL, D., "Utilizing numerical analysis of unsaturated seepage to design tailings management strategy", Uranium Mill Tailings Management (Proc. 6th Symp. Fort Collins, CO, 1984), Colorado State University, Fort Collins, CO (1984) 115-124.

DOWN, C.G., MILLS, A.J.B., "Marine disposal of mine and mill tailings" (Proc. Commonwealth Mining and Metallurgical Congr. Hong Kong, 1978) (JONES, M.J., Ed.), IMM, London (1978) 421-432.

KNIGHT, R.B., HAILE, J.P., "Sub-aerial deposition with underdrainage", PAN AM '83, Soil Mechanics and Foundation Engineering (Proc. 7th Pan-American Conf.), Vol. 2, Engineering Institute of Canada, Montreal (1983) 627-639.

ROBERTSON, A.M., BAMBERG, S.A., LANGE, G., "Current uranium mill waste disposal concepts: A multinational viewpoint", Uranium Mill Tailings Management (Proc. Symp. Fort Collins, 1978), Colorado State University, Fort Collins, CO (1978).



ROBERTSON, A.M., FISHER, J.W., VAN ZYL, D., "The production and handling of dry uranium and other tailings", Uranium Mill Tailings Management (Proc. Symp. Fort Collins, 1982), Colorado State University, Fort Collins, CO (1982) 55-68.

ROBERTSON, A.M., KNAPP, R.A., WELLS, L.A., SKERMER, N.A., Canadian Uranium Mill Waste Disposal Technology, Contract Rep. No. 15SQ.23317-6-1730, Dept. of Energy, Mines and Resources, Ottawa (1987).

ROBERTSON, A.M., VAN ZYL, D., "Design and construction options for surface uranium tailings impoundments", Uranium Mining Waste Disposal (Proc. 1st Int. Conf. Vancouver, 1980) (BRAUNER, C.O., Ed.), Society of Mining Engineers of the AIME, New York (1980).

ROBINSKY, E.I., Thickened discharge — A new approach to tailings disposal, CIM Bull. 68 (1975) 47-53.

— "Tailings disposal by the thickened discharge method for improved economy and environmental control", Tailing Disposal Today, Vol. 2 (ARGALL, G.O., Ed.), Miller Freeman, San Francisco (1979) 75-92.

### **Water Management**

GAUTHIER, J.G.L., "Removal of heavy metals from tailings recycle water at Mattabi Mines Ltd.", paper presented at Canadian Mineral Processors Ann. Mtg Ottawa, 1980, Canada Centre for Mineral and Energy Technology, Ottawa (1980) 94-113.

JOE, E.G., "Water and solution recycling practice in the Canadian mineral industry", paper presented at Joint Int. Conf. on Mineral Processing and Extractive Metallurgy (IMM and CSM), Kunming, China, 1984.

JOE, E.G., PICKET, D.E., Water re-use in Canadian ore-concentration plants — present status, problems and progress, paper No. 19 presented at 1974 IMM Mtg London, IMM, London.

RANDOL INTERNATIONAL Ltd, Water Management and Treatment for Mining and Metallurgical Operations, Vol. 1, Randol International Ltd, Golden, CO (1985).

SAUNDERS, M.P., SHELBURNE, K.L., "Development of a water management plan for the proposed Copper Mountain project", paper presented at Society of Mining Engineers of the AIME Ann. Mtg Chicago, 1981.

SWAISGOOD, J.R., TOLAND, G.C., "The control of water in tailings structures", Tailing Disposal Today (ALPIN, C.L., ARGALL, G.O., Eds), Miller Freeman, San Francisco (1973).

### **Weathering and migration**

ALLARD, B., KIPATSI, H., TIRSTENFELT, B., RYBERG, J., "Nuclide transport by groundwater in Swedish bedrock", Scientific Basis for Nuclear Waste Management, Vol. 1 (McCARTHY, G.J., Ed.), Plenum Press, New York (1979) 403-410.

BARSGAD, I., "Weathering — chemical", The Encyclopaedia of Geochemistry and Environmental Sciences (FAIRBRIDGE, R.W., Ed.), Van Nostrand Reinhold, Princeton, NJ, and New York (1972) 1264–1269.

B.C. RESEARCH, Waste Characterization Studies of Typical Waste Rocks from the Crandon Mineral Deposit, B.C. Research, Vancouver, BC (1982) 93.

BERNER, R.A., Principles of Chemical Sedimentology, McGraw-Hill, New York (1971).

BERTHELIN, J., BOYMOND, D., "Some aspects of the role of heterotrophic microorganisms in the degradation of minerals in waterlogged acid soils", Environmental Biogeochemistry and Geomicrobiology, Vol. 2 (KRUMBEIN, W.E., Ed.), Ann Arbor Science, Ann Arbor, MI (1978) 659–672.

BLAIR, R.D., CHERRY, J.A., LIM, T.P., VIVYURKA, A.J., "Groundwater monitoring and contaminant occurrence at an abandoned tailings area, Elliot Lake, Ontario", Uranium Mine Waste Disposal (Proc. 1st Int. Conf. Vancouver, 1980) (BRAWNER, C.O., Ed.), Society of Mining Engineers of the AIME, New York (1980) 411–444.

BRIDGES, E.M., World Soils, Cambridge University Press, Cambridge (1970).

BROWNLOW, A.H., Geochemistry, Prentice-Hall, Englewood Cliffs, NJ (1979).

BUSH, K.J., MARKOS, G., "Application of geochemical modelling to solute transport modelling of contaminant migration away from uranium mill tailings", Uranium Mill Tailings Management (Proc. 6th Symp. Fort Collins, 1984), Colorado State University, Fort Collins, CO (1984) 135–144.

CARUCCIO, F.T., GEIDEL, G., PELLETIER, M., Occurrence and prediction of acid drainage, J. Energy Div. (May 1981) 167–178.

CHERRY, J.A., SHEPHERD, T.A., MORIN, K.A., "Chemical composition and geochemical behaviour of contaminated groundwater at uranium tailings impoundments", paper presented at the Society of Metallurgical Engineers of the AIME Ann. Mtg Dallas, TX, 1982 (Preprint No. 82-114, 1982).

CONNELL, W.E., PATRICK, W.H., Jr., Sulphate reduction in soil: effects of redox potential and pH, Science (Washington, D.C.) 159 (1968) 86–87.

COOK, R.B., "The impact of acid deposition on the cycles of C, N, P, and S", The Major Biogeochemical Cycles and Their Interactions (BOLIN, B., COOK, R.B., Eds), Wiley, New York (1983) 345–364.

DANIEL, J.A., HARRIES, J.R., RITCHIE, A.I.M., "The temperature distribution and heat transfer in a waste rock dump undergoing pyritic oxidation", Proc. 2nd Appl. Phys. Conf. of the AIP, 1981, Vol. 1 (1981) 189.

DAVE, N.K., LIM, T.P., VIVYURKA, A.J., "Chemical and radioisotope distribution profiles in an abandoned uranium tailings pile", Uranium Mill Tailings Management (Proc. Symp. Fort Collins, 1981), Colorado State University, Fort Collins, CO (1981) 343–366.

- DOMMERGUES, Y., "Microbial activity in different types of microenvironments in paddy soils", *Environmental Biogeochemistry and Geomicrobiology*, Vol. 2 (KRUMBEIN, W.E., Ed.), Ann Arbor Science, Ann Arbor, MI (1978) 451-466.
- DREESEN, D.R., WILLIAMS, J.M., MARPLE, M.L., GLADNEY, E.S., PERRIER, D.R., *The Mobility and Bioavailability of Uranium Mill Tailings Contaminants*, Rep. LA-UR-81-3733, Los Alamos National Laboratory, NM (1981).
- GARRELS, R.M., MACKENZIE, F.T., HUNT, C., *Chemical Cycles and the Global Environment*, Kaufman, Los Altos, CA (1975) 206.
- GARY, M., McAFEE, R., WOLF, C.L. (Eds), *Glossary of Geology*, American Geological Institute, Washington, DC (1972) 422.
- GOLDICH, S.S., *A study in rock weathering*, *J. Geol.* **46** (1938) 17-58.
- HARRIES, J.R., RITCHIE, A.I.M., "The impact of rehabilitation measures on the physiochemical conditions within mine wastes undergoing pyritic oxidation", *Fundamental and Applied Biohydrometallurgy* (LAWRENCE, R.W., BRANION, R.M.P., EBNER, H.G., Eds), Elsevier, Amsterdam and New York (1986) 341-351.
- HAVILIK, B., GRAFOVA, J., NYCOVA, B., Radium-226 liberation from uranium ore processing mill waste solids and uranium rocks into surface streams. Part 1 — The effect of different pH of surface waters, *Health Phys.* **14** 5 (1968) 417-422; Part 2 — The effect of different chemical composition of surface water, *Health Phys.* **14** 5 (1968) 423-430.
- KAUFMANN, R.F., *Hydrogeologic influence on the long term disposal of uranium mill tailings*, paper presented at Groundwater Pollution Conf., Australian Water Resources Council, Perth (1979).
- KELLER, W.D., *The Principles of Chemical Weathering*, Lucas Brothers Publishers, Columbia, MI (1957).
- LERMAN, A., *Geochemical Processes, Waste and Sediment Environments*, Wiley-Interscience, New York (1979).
- LIKENS, G.E., "Interactions between major biogeochemical cycles in terrestrial ecosystems", *Some Perspectives of the Major Biogeochemical Cycles* (LIKENS, G.E., Ed.), Wiley, New York (1981) 93-112.
- LONGMIRE, P., BROOKINS, D., "Trace metal, major element and radionuclide migration in groundwater from an acid leaching uranium tailings in the Grants Mineral Belt, New Mexico", *Uranium Mill Tailings Management (Proc. Symp. Fort Collins, 1982)*, Colorado State University, Fort Collins, CO (1982) 315-333.
- LOUGHMAN, F.C., *Chemical Weathering of the Silicate Minerals*, Elsevier, Amsterdam and New York (1969).
- MARKOS, G., BUSH, K.J., "Evaluation of interface between tailings and subtailings soil. A case study: Vitro Tailings, Salt Lake City, Utah", *Uranium Mill Tailings Management (Proc. Symp. Fort Collins, 1981)*, Colorado State University, Fort Collins, CO (1981) 135-153.

RITCEY, G.M., SILVER, M., Lysimeter investigations on uranium tailings at CANMET, CIM Bull. **75** (1982) 134-143.

SCHNITZER, M., "Reactions of humic substances with minerals in the soil environment", Environmental Biogeochemistry and Geomicrobiology (KRUMBEIN, W.E., Ed.), Ann Arbor Science, Ann Arbor, MI (1978) 639-647.

SCHNITZER, M., HANSEN, E.H., Organo-metallic interactions in soils: 8 — An evaluation of methods for the determination of stability constants of metal-fulvic acid complex, Soil Sci. **109** (1970) 333-340.

SHEPHERD, T.A., BROWN, S.E., "A generic model of contaminant migration from uranium tailings impoundments", Uranium Mill Tailings Management (Proc. Symp. Fort Collins, 1982), Colorado State University, Fort Collins, CO (1982) 241-267.

SILVER, M., RITCEY, G.M., "A simulation of the effects of bacteria, organics and salt solutions on uranium mine mill tailings from Elliot Lake, Ontario", Waste Treatment and Utilization 2 (MOO-YOUNG, M., FARQUHAR, G.J., Eds), Pergamon Press, Oxford (1982) 489-501.

STRUM, W., MORGAN, J.J., Aquatic Chemistry — An Introduction Emphasizing Chemical Equilibria in Natural Waters, 2nd edn, Wiley, New York (1981) 270.

TILSLEY, J.E., Electrochemical Interpretation of Some Geochemical Phenomena, paper presented at 7th Int. Geochemical Exploration Symposium, Golden, CO, 1978.

### **Effluent treatment**

ARDEN, T.V., Ion exchange processes in the atomic industry, Australas. Inst. Min. Metall. Bull. **198** (1961) 153-207.

ARNOLD, W.D., CROUSE, D.J., Radium removal from uranium mill effluents with inorganic ion exchangers, Ind. Eng. Chem. Process Des. Dev. **4** 3 (1965) 333-337.

BHATTACHARYA, D., JUMAWAN, A.B., GRIEVES, R.B., Separation of toxic metals by sulphide precipitation, Sep. Sci. Technol. **14** 5 (1971) 441-452.

CARTWRIGHT, P.S., "Industrial effluent applications of membrane separation technologies", Chemical Separations, Vol. II (KING, C.J., NAVRATIL, J.D., Eds), Litarvan Literature, Denver, CO (1986) 81-94.

GALE, N.L., "The role of algae and other microorganisms in metal detoxification and environmental cleanup", Biotechnology for the Mining, Metal-Refining, and Fossil Fuel Processing Industries (EHRlich, H.L., HOLMES, D.S., Eds), Wiley, New York (1986) 171-180.

ITZKOVITCH, I.J., RITCEY, G.M., Removal of Radionuclides from Process Streams — A survey, Rep. 79-21, Dept. of Energy, Mines and Resources, Ottawa (1979).

KALIN, M., VAN EVERDINGEN, R.O., "Ecological engineering: biological and geochemical aspects: Phase 1 experiments", *Acid Mine Drainage (Proc. Sem./Workshop Halifax, 1987)*, Environment Canada, Ottawa (1987) 565-590.

KLEINMANN, R.L.P., "Treatment of acid mine water by wetlands", *Control of Acid Mine Drainage (Proc. Sem. Pittsburgh, 1985)*, USBM Information Circular IC 9027, US Bureau of Mines, Washington, DC (1985) 48-52.

KUIT, W.J., Mine and tailings effluent treatment at the Kimberley, B.C. operation of Cominco Ltd, *CIM Bull.* 73 (1980) 105-112.

OPITZ, V.W., SHERWOOD, D.R., "Neutralizing barrier for reducing contaminant migration from a uranium mill tailings disposal pond", *Uranium Mill Tailings Management (Proc. 6th Symp. Fort Collins, 1984)*, Colorado State University, Fort Collins, CO (1984) 93-103.

PESAVENTO, B.G., "Factors to be considered in the use of wetlands to treat acid mine drainage", *Acid Mine Drainage (Proc. Sem./Workshop Halifax, 1987)*, Environment Canada, Ottawa (1987) 499-505.

RANDOL INTERNATIONAL Ltd, *Water Management and Treatment for Mining and Metallurgical Operations, Vol. 1*, Randol International Ltd, Golden, CO (1985).

RITCEY, G.M., ASHBROOK, A.W., *Solvent Extraction — Principles and Applications to Process Metallurgy, Vol. 1*, Elsevier, Amsterdam and New York (1984).

— *Solvent Extraction — Principles and Applications to Process Metallurgy, Vol. 2*, Elsevier, Amsterdam and New York (1979).

STRANDBERG, G.W., SHUMATE, S.E., PARROTT, J.R., Microbial cells as biosorbents for heavy metals: Accumulation of uranium by *S. cerevisiae* and *P. ueruginosa*, *Appl. Environ. Microbiol.* 41 (1981) 237-245.

STUMM, W., MORGAN, J.J., Chemical aspects of coagulation, *J. Am. Water Works Assoc.* 54 8 (1962) 971-994.

VAN DER WEIJDEN, C.H., VAN LEEUWEN, M., The effect of the pH on the adsorption of uranyl onto peat, *Uranium 2* (1985) 59-66.

VAN ZYL, D., SHEPHERD, T.A., SMITH, A.C.S., "Quality of seepage and leachate from mine and mill wastes and control of its effluents", paper presented at 61st Ann. Mtg of the Transportation Research Board Washington, DC, 1982.

### **Decommissioning, reclamation, and covers**

BEEDLOW, P.A., CADWELL, L.L., McSHANE, M.C., "A systematic approach to designing surface covers for uranium mill tailings", *Uranium Mill Tailings Management (Proc. Symp. Fort Collins, 1982)*, Colorado State University, Fort Collins, CO (1982) 397-407.

BLACK, C.A. (Ed.), *Methods of Soil Analysis, Part II*, American Society of Agronomy, Madison, WI (1965).

BLACK, R.F., TRUDINGER, J.P., "Revegetation of mine wastes and disturbed areas in an acid environment, landscaping and land use planning as related to mining operations" (Proc. Aus. IMM Adelaide Branch Landscaping Sem. 1976), Australasian IMM, Parkville, Victoria (1976) 167-175.

BUCHMAN, H.O., BRADY, N.C., *The Nature and Properties of Soils*, Macmillan, London and New York (1960).

BUSH, K.J., MARKOS, G., "Investigation of contamination of earthen covers on inactive uranium mill tailings", *Uranium Mill Tailings Management* (Proc. 6th Symp. Fort Collins, CO, 1984), Colorado State University, Fort Collins, CO (1984) 145-154.

DANIEL, J.A., HARRIES, J.R., RITCHIE, A.I.M., "The transport of oxygen into a waste rock dump undergoing pyritic oxidation", *Proc. 2nd Appl. Phys. Conf. of the AIP*, Vol. 1, American Institute of Physics (1981) 185.

DEAN, K.C., HAVENS, R., "Reclamation of mineral milling wastes", paper presented at AIME Ann. Mtg San Francisco, 1972, AIME Preprint No. 72-B-82 (1972).

DEAN, K.C., HAVENS, R., "Comparative costs and methods for stabilization of tailings", *Tailing Disposal Today* (ALPIN, C.L., ARGALL, G.O., Eds), Miller Freeman, San Francisco (1973) 450-476.

DEPARTMENT OF ENERGY, MINES AND RESOURCES, *The Pit Slope Manual*, Vols 1-10, Dept. of Energy, Mines and Resources, Ottawa (1977).

FREEMAN, H.D., HARTLEY, J.N., GEE, G.W., "Radon barrier field-test monitoring at Grand Junction tailing pile", *Uranium Mill Tailings Management* (Proc. 6th Symp. Fort Collins, 1984), Colorado State University, Fort Collins, CO (1984) 277-285.

GEE, G.W., NIELSON, K.E., ROGERS, V.C., "Predicting long-term moisture in earthen covers", *ibid.*, 267-276.

JONGEJAN, A., RITCEY, G.M., *Compost Production from Municipal Wastes of Canadian Mining Towns*, Rep. MRP/MSL 81-73 (OP&J), Dept. of Energy, Mines and Resources, Ottawa (1981).

KALIN, M., *Long Term Ecological Behaviour of Abandoned Uranium Mill Tailings — Growth Patterns of Indigenous Vegetation on Terrestrial and Semi-Aquatic Areas*, Rep. EPS 3/HA3/2, Environment Canada, Ottawa (1984).

KROFCHAK, D., *Stepwise Treatment of Aqueous Waste to Form Solid Silicates*, Canadian Patent 1,024,277 (10 January 1978).

LAKSHMANAN, V.I., LUCKEVICH, L.M., RITCEY, G.M., SKEAFF, J.M., *Evaluation of tailings stabilization methods as applied to uranium tailings*, *Hydrometall.* **12** (1984) 31-48.

MARCUS, D., SANGREY, D.A., "Stabilization of fine uranium mill tailings", *Uranium Mill Tailings Management* (Proc. Symp. Fort Collins, 1981), Colorado State University, Fort Collins, CO (1981) 489-505.

**Monitoring of tailings impoundment sites**

HICKEY, J.W.N., Radiological effluent and environmental monitoring of uranium mills: A regulatory viewpoint, *Trans. Am. Nucl. Soc.* **27** (1977) 149-150.

SCHIEFER, K., LUSH, D., Environmental monitoring: A new requirement for the mining industry, *Can. Min. J.* **96** (1975) 52-58.

**The model**

ALEXANDER, M., *Microbial Ecology*, Wiley, New York (1971).

BRIDGES, E.M., *World Soils*, Cambridge University Press, Cambridge (1970).

CARNAHAN, T.G., LUCAS, M.A., Weathering of a Base-Metal Sulphide Leaching Residue, USBM Rep. RI 8667, United States Bureau of Mines, Washington, DC (1982).

CHERRY, J.A., et al., "Subsurface hydrology and geochemical evolution of inactive pyrite tailings in the Elliot Lake uranium district", *Uranium Mill Tailings Management (Proc. Symp. Fort Collins, 1980)*, Colorado State University, Fort Collins, CO (1980).

CHOMYN, B.A., RITCEY, G.M., Simulated Weathering Studies on Uranium-Nickel-Arsenide Tailings from Midwest Lake, Saskatchewan, Dept. of Energy, Mines and Resources, Ottawa (1987).

HAVILIK, B., GRAFOVA, J., NYCOVA, B.,  $^{226}\text{Ra}$  liberation from uranium ore processing mill waste solids and uranium rocks into surface streams — Part 1: The effect of different pH of surface waters, *Health Phys.* **14** 5 (1968) 417-422.

LAKSHMANAN, V.I., Long Term Monitoring of High Grade Uranium Mill Tailings, Contract Rep. No. OSQ82-00264, Dept. of Energy, Mines and Resources, Ottawa (1985).

MARKOS, G., BUSH, K.J., "Physico-chemical processes in uranium mill tailings and their relationship to contamination", *Uranium Ore Processing/Tailings Conditioning for Minimizing Long-term Environmental Problems in Tailings Disposal (Proc. two NEA Workshops Fort Collins, 1981)*, Nuclear Energy Agency of the OECD, Paris (1982) 99-114.

MORRIS MAGNETICS, Measurement of Magnetic Susceptibility on Tailings Cores Obtained from the Ontario Research Foundation Lysimeter Experiment, Contract Rep. No. OSQ84-00103, Dept. of Energy, Mines and Resources, Ottawa (1984).

MURRAY, F.H., FYFE, W.S., KRONBERG, B.I., A Study of the Surface Chemistry of Uranium Mine Tailings during Weathering, Contract Rep., Dept. of Energy, Mines and Resources, Ottawa (1985).

PETRUK, W., PINARD, R.G., Mineralogical and Image Analysis Study of Samples from Core WA20 of the Waite Amulet Tailings, Rep. MSL 86-87(IR), Dept. of Energy, Mines and Resources, Ottawa (1986).

— Mineralogical and Image Analysis. Study of Artificially Weathered Tailings from the Midwest Uranium Ore in Saskatchewan, Rep. CM-88-6E, Dept. of Energy, Mines and Resources, Ottawa (1988).

RITCEY, G.M., CHOMYN, B.A., Development of Methodology for Prediction of Migration of Contaminants and Radionuclides from Uranium Tailings based on Lysimeter Experimentation, Rep. MRP/MSL 84-11(OP), Dept. of Energy, Mines and Resources, Ottawa (1984).

RITCEY, G.M., SILVER, M., Lysimeter investigations in uranium tailings at CANMET, CIM Bull. 75 (1982) 134-143.

— Use of Bog Cover to Inhibit Sulphide Oxidation in Tailings, Dept. of Energy, Mines and Resources, Ottawa (1987), unpublished data.

— Deep Water Disposal of Pyritic Tailings — A Simulation, Dept. of Energy, Mines and Resources, Ottawa (1987), unpublished data.

SILVER, M., Analytical Techniques for Research on the Abatement of Bacterial Acid Generation in Pyritic Tailings, Rep. 86-3E, Dept. of Energy, Mines and Resources, Ottawa (1986).

SILVER, M., RITCEY, G.M., Effects of iron-oxidizing bacteria and vegetation on acid generation in laboratory lysimeter tests on pyrite-containing uranium tailings, Hydrometall. 15 (1985) 255-264.

SILVER, M., RITCEY, G.M., CAULEY, M.P., Lysimeter comparison of uranium tailings deposition methods on the release of environmental contaminants, Hydrometall. 15 (1985) 159-172.

SMITH, M.J., "Acid production in mine drainage systems", Extraction of Minerals and Energy: Today's Dilemmas (DEJU, R.A., Ed.), Ann Arbor Science, Ann Arbor, MI (1974) 57-75.

WILES, D.R., Radiochemical Investigations on Uranium Mill Tailings from Saskatchewan and Elliot Lake, Contract Rep. Serial No. OST83-00270, Dept. of Energy, Mines and Resources, Ottawa (1985).





**Part IV**

**FLOW SHEET EXAMPLES**



## Chapter 11

### OLYMPIC DAM

#### 11.1. INTRODUCTION

The Olympic Dam copper-uranium-gold-silver deposit is located 520 km NNW of Adelaide in South Australia. The deposit was discovered in 1975 by the Exploration Division of Western Mining Corporation Limited (WMC). Since 1979, the deposit has been developed as a Joint Venture between WMC and the British Petroleum Group (BP).

Olympic Dam is unique from a metallurgical viewpoint in that four high quality products, uranium, copper, gold and silver, are produced on the one site, with the last three being processed as far as possible.

#### 11.2. GEOLOGY AND RESOURCES

The discovery of the deposit was based on theoretical studies of the formation of copper deposits, which led to the Stuart Shelf region of South Australia being selected as a favourable target area for copper exploration. The Olympic Dam location was chosen on the basis of coincident gravity and magnetic anomalies, and the presence of encouraging tectonic lineaments. There is no surface expression and the deposit lies 350 m below barren sediments.

The deposit is considered to be a large mineralized breccia complex, hosted by granitic rocks approximately 1600 million years old. The main rock types are a variety of breccias, composed principally of fragments of granite, hematite and, less commonly, sediments and volcanic rocks.

The orebody is made up of a large number of individual ore zones, which occur at a variety of attitudes throughout the deposit, from subhorizontal to subvertical. The more hematite rich breccias are most strongly mineralized and the distribution of higher grade mineralization is largely controlled by the distribution of these breccias. Mineralization consists of medium grained disseminated copper sulphides and fine grained disseminated pitchblende. Discrete zones of gold mineralization have also been outlined.

The total inferred resource was stated in 1982 to include 2000 million tonnes of ore at 1.6% Cu, 0.6 kg/t  $U_3O_8$ , 0.6 g/t Au and 3.5 g/t Ag. A more detailed breakdown of reserves is given below.

### 11.3. MINERALOGY

Two major types of ore have been defined, based on the copper mineralogy: one in which the copper mineralization is chalcocite and bornite, and the other in which chalcopyrite and bornite are predominant. The chalcocite-bornite ore generally has higher copper and uranium grades and is therefore selected in mine planning.

The chalcocite-bornite ore has a low sulphur content, with virtually no pyrites. The most common uranium mineral is uraninite, with few localized concentrations of coffinite and brannerite.

Hematite, sericite, K feldspar and quartz are the main gangue minerals with minor barite, fluorite and siderite. The ore has a high specific gravity, typically 3.7, with up to 80% hematite. The uranium is widely dispersed among the gangue minerals with some preference towards association with hematite. Uraninite is not generally associated with sulphides but can occur in bornite-hematite composites.

Low but economically significant levels of gold and silver occur with all copper and uranium mineralizations. Significant concentrations of rare earth elements, especially lanthanum and cerium, are also present. Some discrete zones of gold mineralization have been outlined. Levels of other metals (e.g. Pb, Zn, As, Sb) are low.

### 11.4. PRODUCTION CAPACITY

Milling of ore commenced in June 1988. Production from treating approximately 1.5 Mt of ore per year is 45 000 t of copper, 1200 t of uranium oxide, 700 kg of gold and 14.18 t of silver. In February 1991 WMC announced expansion plans that will increase production to 65 000 t of copper and 1400 t of uranium oxide.

### 11.5. MINING AND MILLING

The operation consists of:

- (a) A mechanized underground mine,
- (b) A copper concentrator,
- (c) A hydrometallurgical plant,
- (d) A copper smelter,
- (e) A copper refinery with combined precious metals plant.

### 11.5.1. Mining

The ore at Olympic Dam is mined by open stoping methods, with postfilling, and extensive use is made of trackless equipment. The standard drive is 6 m wide and 4.8 m high. Decline and incline roadways are driven to gain access over large vertical extents. The ore zones tend to be spatially separated, which allows common access ramps to be located adjacent to a number of current or future production areas.

After stope blasting, ore is extracted through drawpoints at the base of the stope using 7.2 m<sup>3</sup> capacity loaders. These units are used to load trucks indirectly through a system of chutes. The ore is then hauled to a sizing 'grizzly' (with apertures of 950 × 950 mm<sup>2</sup>) located above the underground crushing station. Secondary breakage on the 'grizzly' is carried out using a mobile rock breaker.

Feed for the primary jaw crusher is supplied by a plate feeder. Undersized material is 'scalped' by a vibrating 'grizzly' feeder and the oversized material crushed to a nominal size of -200 mm. Crushed rocks and 'scalped' fines are then transferred onto the main underground conveyer belt, which discharges them into fine rock storage bins. These bins discharge via vibrating feeders into 9.25 t bottom dump skips, which are then hoisted to the surface. The skips tip into a surface surge bin. Rock is then conveyed 1.2 km to the mill stockpiles.

#### 11.5.1.1. Stope backfill

When extraction from primary open stopes is completed, a backfill in the form of a cemented aggregate fill is introduced. This is comprised of crushed mullock and deslimed mill tailings mixed with a slurry of water, cement and fly ash. A filling strength of 2 MPa allows the fill to stand unsupported over the full height during the extraction of adjacent stopes.

Backfill production is by an automatic batching process, which feeds the premeasured material into either of two 6 m<sup>3</sup> mixing bowls at the rate of 100 m<sup>3</sup> · h<sup>-1</sup>. After mixing, the product is discharged into dump trucks at the rear, which deliver the backfill material to 300 mm boreholes drilled from the surface directly into the rears of the stopes.

### 11.5.2. Copper concentrator

The concentrator section consists of the grinding and flotation circuits. The liberated copper sulphide particles are floated to produce a concentrate, while the uranium minerals and gangue are rejected to the tailings.

### 11.5.2.1. Grinding

The -200 mm ore from the mill stockpile is conveyed to a primary autogenous mill to reduce the particle size to a  $P_{80}$  value (80% passing) of 12 mm. The discharge from the mill is pumped to DSM screens. The screen oversize is recycled to the autogenous mill and the fines are fed to the secondary ball mill to yield a product with a  $P_{80}$  value of 75  $\mu\text{m}$  (and a work index of 16  $\text{kW}\cdot\text{h}/\text{t}$ ), which is fed to the flotation circuit.

### 11.5.2.2. Flotation

The flotation circuit is designed for the simple bulk flotation of all sulphide minerals, as the ore contains no iron sulphides. All flotation cells are Dorr Oliver two cell assemblies. The first stage cleaner concentrate is ground to 20  $\mu\text{m}$  and recleaned in the second and third flotation stages. Even with this fine grinding some uraninite (about 8–10% of the uranium in the ore) remains in the sulphide product, which is about 7% by weight of the ore feed. The reagents used are sodium ethyl xanthate and methyl isobutyl carbinol (MIBC).

The concentrates are dewatered in a conventional thickener and pumped to the concentrate leach circuit for extraction of uranium prior to smelting. Flotation tailings are dewatered in a Larox high rate thickener and sent to the tailings leach section.

## 11.5.3. Hydrometallurgical plant

The hydrometallurgical plant comprises the concentrate and tailings leach circuits for the extraction of uranium (and some copper), the solid-liquid separation and classification sections and solvent extraction circuits for the recovery of uranium and copper. The resulting copper strip liquor from solvent extraction is processed in the copper refinery. Yellow cake is produced from the uranium strip liquor by precipitation and calcination. A block diagram of the flow sheet is shown in Fig. 11.1.

### 11.5.3.1. Uranium leaching

The flotation tailings are leached under the following conditions in five mechanically agitated tanks to extract uranium and copper:

Residence time	10 h;
Temperature	55°C (by injection of steam);
Slurry density	55 wt%;
Acidity	pH1.5–1.8 (first two tanks);
Acid addition	30 kg/t ore;

Oxidation potential	420 mV saturated calomel (first two tanks);
NaClO <sub>3</sub> addition	2 kg/t ore;
Uranium extraction	75–80%;
Copper extraction	50%.

The copper concentrates are leached under conditions chosen to achieve maximum uranium extraction with minimum dissolution of copper. The free acid levels are much higher than in the tailings leaching circuit and no oxidant is added. The leaching conditions are as follows:

Acidity	100 g/L H <sub>2</sub> SO <sub>4</sub> (first tank);
Temperature	60°C;
Slurry density	40 wt%;
Residence time	36 h;
Acid addition	300 kg/t of ore;
Uranium extraction	75%.

The overflow slurry from the last concentrate leaching tank is pumped to a thickener. Underflow from the thickener is filtered and washed on an automatic Lasta pressure filter. The leaching filtrate and the washing filtrate are returned to the leaching thickener, and the overflow from the thickener is pumped to the tailings leaching circuit, where the residual acidity reduces the acid requirements for this circuit.

The copper concentrate filter cake is repulped and neutralized with caustic soda before being refloatated. Reflotation rejects further gangue (leaching debris) and enhances the Cu content. The final concentrate is pumped to the smelter feed preparation area as a 25% slurry at a typical grade of 55% Cu.

#### 11.5.3.2. Solid–liquid separation

The leach slurry from the tailings leaching circuit is washed in a five stage CCD circuit and the tailings pass to the tailings desliming unit or the tailings dam.

The CCD circuit is designed with a wash ratio of liquor to solids of 2.6 m<sup>3</sup>/t ore. The thickeners are Larox ‘high rate’ filter bed units in which the incoming feed pulp (at 15 wt%) is flocculated and then injected below the surface of a deep fluidized pulp bed.

Overflow from the first CCD circuit passes to the clarification section, where the levels of silica and suspended solids are reduced. Because of the presence of fine colloidal silica, a coagulant is added in the first of two short retention time mixing tanks. In the second tank, flocculant and recycled clarifier underflow are also introduced. The solution is then passed through a 25 m diameter conventional sedimentary clarifier, followed by solution polishing in a bank of three parallel multimedia AbTech sand filters. The filter media is composed of five layers of



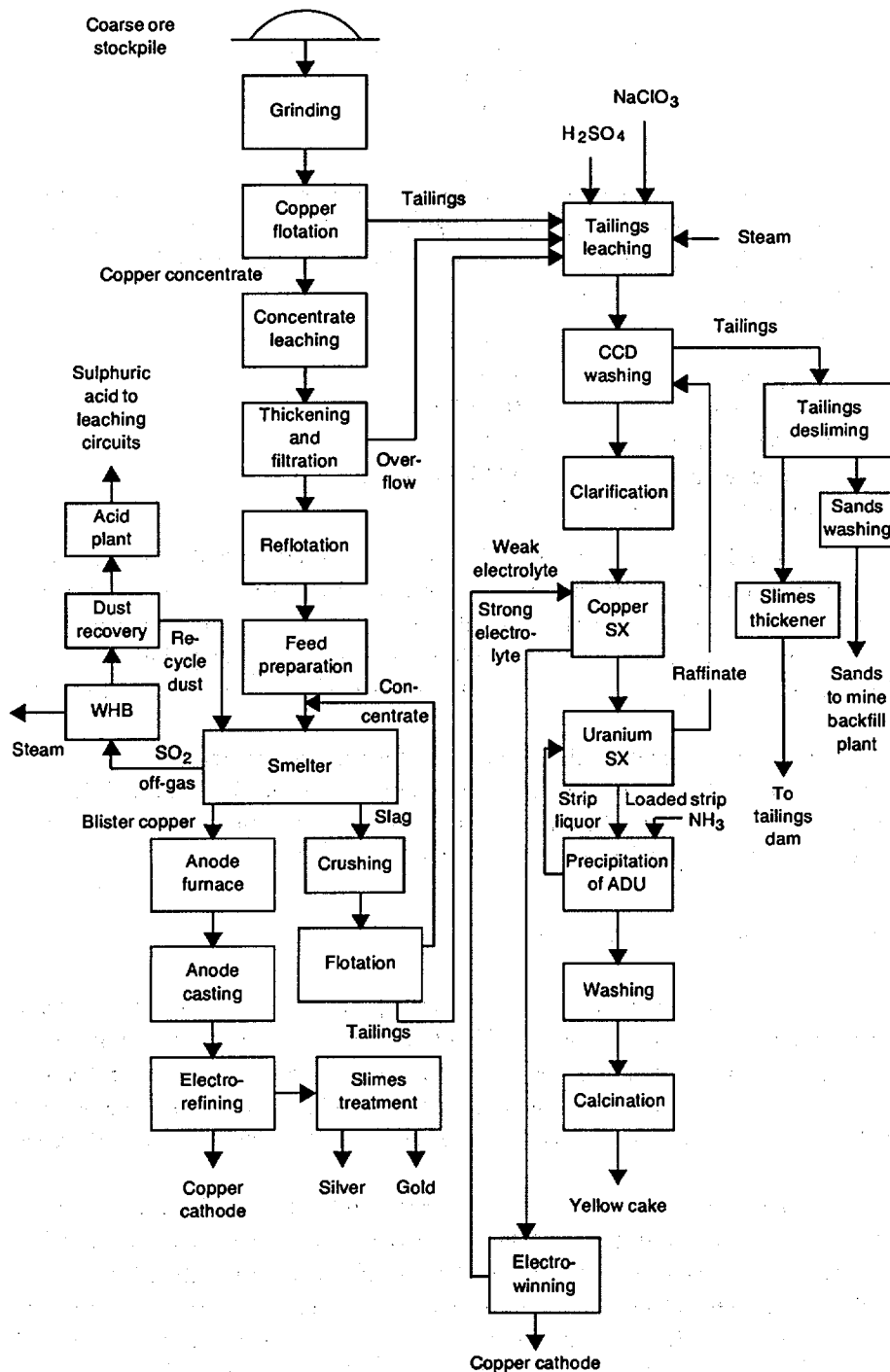

FIG. 11.1. Schematic diagram of process at Olympic Dam (WHB, waste heat boiler).

graded silica sand topped by a fine layer of anthracite. The pregnant liquor, containing 30–50 ppm suspended solids, is then passed to solvent extraction.

The underflow slurry from the first CCD thickener is diverted to either the tailings dam or deslimed in cyclones. The slimes are thickened in a 39 m diameter conventional unit and the underflow at 30–40 wt% solids is pumped to the tailings dam. The tailings are deposited using the subaerial disposal technique.

Sands from the sizing cyclones are washed and further deslimed in a four stage countercurrent washing cyclone circuit. The washed sands are neutralized with a lime slurry before being pumped to the backfill preparation plant (see Section 11.5.1.1).

### 11.5.3.3. Solvent extraction

Two separate circuits are used to recover copper and uranium. The first extracts copper from the leach liquor using an oxine–kerosine solvent in Krebs mixer settlers. The solvent system comprises LIX 622 (8%) in a Shellsol 2046 diluent. Two stages of extraction are employed, with solvent recycling being controlled to achieve an organic to aqueous (O/A) ratio of 1.9 with organic continuous emulsions. The loaded solvent is then scrubbed in a single stage with potable water and finally stripped using spent electrolyte (about 200 g/L  $H_2SO_4$ ) from the electrowinning cells in a single stage at an O/A ratio of 2.3:1. The resulting strong copper electrolyte is recycled to the copper refinery. The scrubbing and stripping units are operated in the organic continuous mode, with recycling of aqueous material.

The raffinate from copper extraction passes via an aftersettler to the uranium solvent extraction unit. Uranium is extracted in three stages using an amine–kerosine solvent in Krebs mixer settlers. The solvent system is 3% Alamine 336 in Shellsol 2046 diluent, with 2% isodecanol as a modifier. The extraction circuit is operated in the organic continuous mode, with solvent recycling to give an O/A ratio of 1.5–1.7:1 in the mixer.

Raffinate from the third extraction stage overflows to an aftersettler to reduce the solvent losses, before recycling to the CCD circuit as a washing liquor. The loaded solvent is scrubbed in three stages with acidified water. The scrubbing is followed by four stages of stripping with ammonium sulphate solution, assisted by the injection of gaseous ammonia to raise the aqueous pH to between 4 and 5. The stripped solvent is then preacidified in a single stage by contact with sulphuric acid solution (pH 1.0) before recycling to extraction. The solvent is regularly regenerated by prolonged contact with sodium carbonate solution. The scrubbing, stripping and regeneration units are operated in the organic continuous mode, with recycling of the aqueous material.

#### *11.5.3.4. Precipitation and calcination*

Uranium is precipitated from the loaded ammonium sulphate stripping solution as ADU. Precipitation takes place in two identical agitated tanks. In the first, ammonia and air are added to raise the value of the pH to between 6.5 and 7.0, and in the second to between 7.0 and 7.5. The total retention time is about 1.5 h.

After precipitation, the ADU slurry is thickened and then washed. The underflow from the wash thickener is dewatered in a centrifuge. The dried yellow cake is fed by a screw conveyor into the top hearth of a multiple hearth Skinner furnace operating at about 760°C. The exhaust gas from the calciner is cleaned in a high energy venturi type scrubber before being discharged.

The resultant oxide product contains about 0.1% moisture and typically 98% U<sub>3</sub>O<sub>8</sub>. The yellow cake is loaded into 200 L drums in an automatic batch operation. The packing operation is served by its own dust extraction system.

#### **11.5.4. Copper smelter**

Smelting of the copper concentrate is carried out in an Outokumpo designed flash furnace. The feed materials are the concentrate, the flux (siliceous sand) and the dust recycled from the furnace off-gas system. The feed combusts in 70% oxygen enriched air. Oxygen is supplied from a 100 t/d basic oxygen converter (BOC) plant located adjacent to the smelter. Smelting produces blister copper direct from the high grade copper concentrate. The blister and slag layers in the furnace smelter are removed by tapping.

The off-gas from the furnace (containing 27–35% SO<sub>2</sub>) is cooled to 400°C in a Ahlström waste heat boiler and then passed to a Flakt electrostatic precipitator to remove the dust (approximately 20% of the concentrate feed), which is recycled to the furnace feed. The off-gas is then directed to a 275 t/d acid plant, which supplies around 90% of the acid requirements for the tails and concentrate leaching circuits. Additional acid is obtained by burning sulphur. Heat generated both in the smelter and acid plant is recovered by raising steam which is used in the tails leaching circuit.

Blister copper tapped from the furnace contains approximately 0.6% S and 98% Cu. The slag contains around 20% Cu and, following slow cooling, is further treated to recover 60% of the copper content by crushing, milling and flotation. The floated copper is returned to the smelter and the flotation tails are pumped to a separate leaching circuit in the hydrometallurgical plant to recover copper and uranium. The leached slurry from this circuit is directed into the feed of the main CCD circuit.

Fire refining of blister copper is undertaken in one of two anode furnaces. Oxidation of sulphur is carried out by first blowing air, then liquid propane gas (LPG), to reduce the oxygen level. The off-gas passes to the atmosphere via after-burners and a 40 m stack.

Anode casting is carried out using a Sumitomo casting wheel. The gold and silver in the smelter feed concentrate follow the copper into the anodes.

#### 11.5.5. Copper refinery and precious metals plant

The ISA electrorefining process, which was developed in Australia, is used to produce high quality copper cathodes. The refining of the anodes is carried out in over 200 electrolytic cells using a copper sulphate and sulphuric acid electrolyte. Each cell contains 55 impure copper anodes and 54 stainless steel mother plates as cathodes.

The anodes have a life of 21 days and from them three crops of seven day cathodes are stripped. At this time, the mother plates are removed, washed and the copper is stripped in an automatic stripping machine. The plates undergo further treatment and are then returned to the cells. The high purity cathodes are bundled in approximately 2.5 t lots ready for shipment.

During electrorefining, soluble impurities in the anode (As, Ni, Co, Sb, Bi and Fe) dissolve in the electrolyte while insoluble impurities (Au, Ag, Se, Te, Pb) form a slime at the anode that gravitates to the bottom of the cell; these slimes contain most of the Au and Ag from the original ore. The slimes are processed to remove Cu, and the precious metals are then extracted by intensive cyanidation followed by electrorefining to produce gold and silver bullion.

Approximately 10% of the total copper recovered at Olympic Dam is electro-won from the loaded strip solution produced in the copper solvent extraction section of the hydrometallurgical plant. Electrowinning is carried out in 43 cells, each with 55 lead anodes and 54 stainless steel mother plates. The electrowinning cells are stripped on a rotational basis with all 43 cells being stripped each week.

#### REFERENCES

- [11.1] CREW, R.J., "Mining and metallurgical practices at Olympic Dam, South Australia", paper presented at German Association of Int. Mining Conf. Bergbau, 1989.
- [11.2] KENNEDY, A., Olympic Dam project, Min. Mag. (Nov. 1988) 330-344.



## Chapter 12

### KEY LAKE

#### 12.1. INTRODUCTION

The Key Lake uranium deposits are located in the south east rim of the Athabasca basin in northern Saskatchewan. The Gaertner orebody was discovered in the summer of 1975, and the Deilmann orebody in 1976. Key Lake Mining Corporation, the operating company, is a joint venture of CAMECO and Uranerz Exploration and Mining Limited. CAMECO was formed when the Saskatchewan Mining Development Corporation and Eldorado Nuclear merged in 1988.

#### 12.2. GEOLOGY AND RESOURCES

The two orebodies, which are narrow and elongated, are relatively close to the surface. They are covered with a 20 to 100 m thick layer of glacial sediments and/or lakes and in some places with barren sandstone. The structure of the Key Lake ore deposits is controlled by the intersection of two main structures, the unconformity at the base of the Athabasca formation and a ENE trending fault zone that crosses the unconformity. The maximum width and thickness of the Gaertner orebody are approximately 80 and 50 m, respectively. The respective dimensions of some segments of the Deilmann orebody extend to about 200 and 100 m.

Uranium mineralization is located primarily in three rock units. The upper section of the orebody is contained in horizontal beds of sandstone and conglomerate and the central portion occurs in kaolinized residual rock (the so-called regolith). The lower section occurs in a sequence of biotite gneiss, graphitic gneiss and subordinate pegmatoid bodies.

The Key Lake ore reserves, as established in 1980, are shown in Table 12.1.

#### 12.3. MINERALOGY

Within the orebodies, the ore occurs in several modes varying from massive veins to disseminations. The mineralogy of the ore in both the Gaertner and Deilmann deposits is similar and is highly diverse. The economic uranium mineralization consists of oxides and silicates of uranium such as pitchblende, sooty pitchblende and coffinite. The uranium minerals are accompanied by sulphides, arsenides and arsenosulphides of nickel, such as millerite (NiS), niccolite (NiAs), and gersdorffite (NiAsS). Minor amounts of lead, zinc, copper, molybdenum, cobalt and

TABLE 12.1. ESTIMATED KEY LAKE ORE RESERVES (AS ESTABLISHED IN 1980)

Ore	Amount (Mt)	U <sub>3</sub> O <sub>8</sub> (%)	U <sub>3</sub> O <sub>8</sub> (t)	Cut-off grade (%)
Gaertner	0.814	3.30	26 880	0.05
Deilmann	2.116	2.49	52 620	0.05
Cobble ore	0.587	0.54	3 171	0.03
Total	3.512	2.35	82 671	—

vanadium are also present in accessory minerals. The matrix of the orebodies consists of gangue minerals such as quartz, chlorite, kaolinite, sericite, calcite and epidote.

#### 12.4. PRODUCTION CAPACITY

The first drum of yellow cake was filled in October 1983, two years after construction commenced. Initial planned capacity was 5443 t of U<sub>3</sub>O<sub>8</sub> per year (4600 tU/a); production has increased in recent years.

#### 12.5. MILLING

The Key Lake mill uses a modified acid leaching solvent extraction process. The overall flow sheet is shown in Fig. 12.1.

##### 12.5.1. Size reduction

A primary gyratory is used to crush the small amount of oversized material that does not pass the 500 mm semiautogenous (SAG) mill feed 'grizzly'. The SAG mill, which is operated in closed circuit, produces a -0.5 mm grind. The SAG mill product slurry is thickened to 50% solids in a neutral thickener prior to pumping to the ground ore pulp storage tanks.

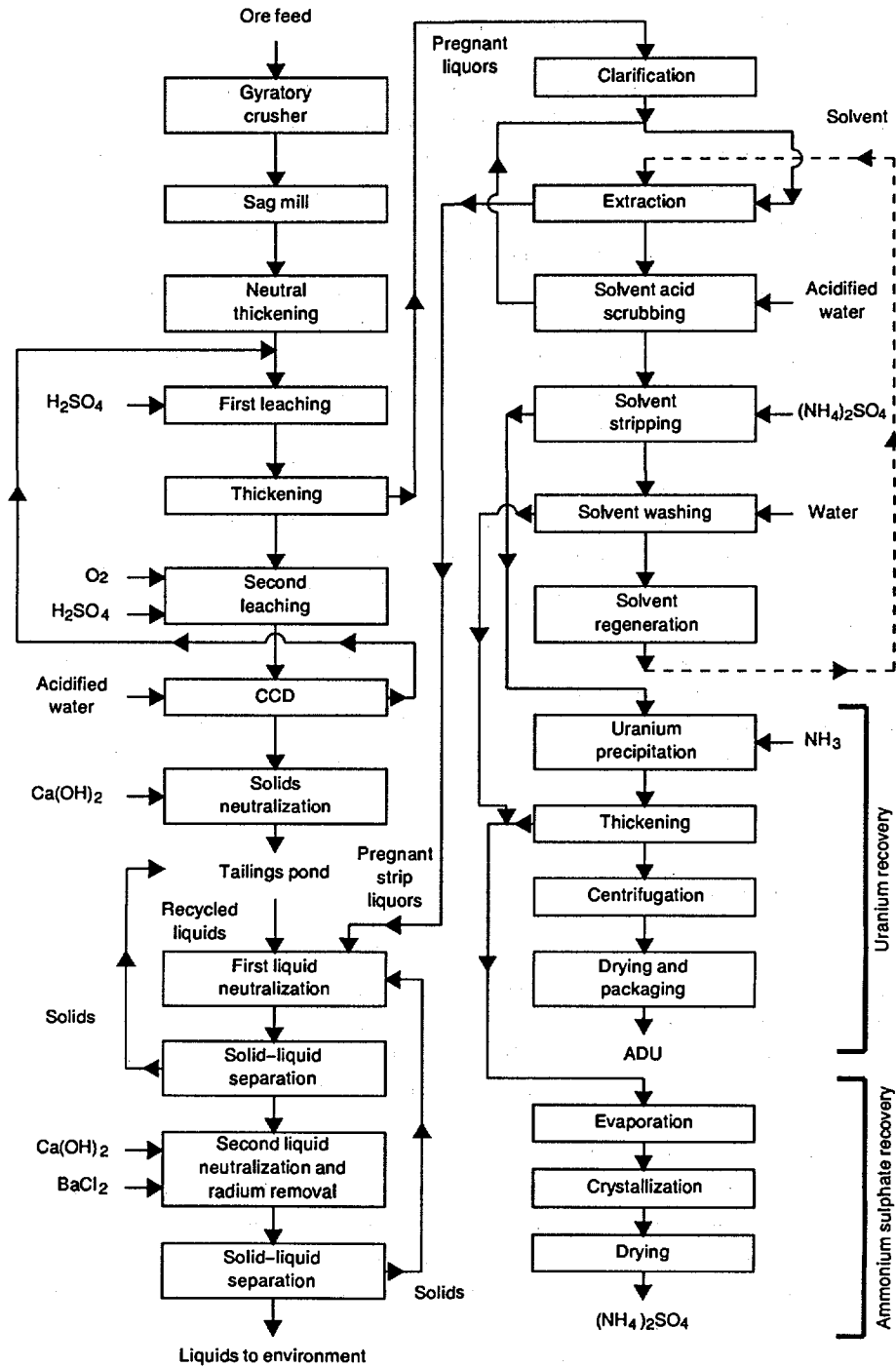

FIG. 12.1. Schematic flow sheet of process at Key Lake. Dashed line shows a side stream.



### 12.5.2. Leaching and solid-liquid separation

A two stage leaching system followed by a counter current decantation circuit operating at relatively high acidity was selected for the Key Lake operation. Pulp from the storage tanks is first diluted with liquor from the second stage leaching CCD thickener and pumped to four Pachuca type reactors, which operate in series. The first-stage leach retention time is two hours. Sulphuric acid is added to both the first and second stage leaches. Pulp from the first stage leach is thickened in a single thickener, the overflow being pumped to solvent extraction as a pregnant solution and the underflow to the second stage autoclave leach.

During the first stage leaching most of the ferric iron in the CCD overflow is reduced to ferrous iron and up to 50% of the uranium is taken into solution. Because ferrous arsenate remains in solution at lower sulphuric acid concentrations than ferric arsenate, lower acid concentrations can be tolerated in the first stage leaching than those that would be required if an appreciable amount of ferric iron was present.

Secondary leaching is conducted at a sulphuric acid concentration of 60 to 100 g/L  $H_2SO_4$  in ten mild steel, rubber lined autoclaves. The autoclaves operate in series, and the maximum residence time is six hours at 60 to 70°C. Oxygen at a pressure of 500 kPa is used as the oxidant.

The leached pulp is transferred to a CCD washing circuit that consists of eight 20 m long thickeners. Contaminated mine water is used as the washing solution, and a free acidity of 20–25 g/L is maintained in each thickener by adding sulphuric acid. This addition prevents precipitation of ferric arsenate and/or adsorption of uranium on clay minerals.

### 12.5.3. Solvent extraction

After clarification, the pregnant leaching solutions are treated in mixer settlers of the KREBS design. The organic phase consists of 6% alamine, 3% isodecanol and 91% kerosine. A four stage mixer settler circuit is used for extraction. The loaded organic phase is scrubbed with acidified water in a three stage mixer settler circuit to remove the arsenic. The resulting aqueous scrub solution is recycled to the extraction stage.

The scrubbed organic phase is then contacted with a 120–150 g/L ammonium sulphate solution in a four stage uranium stripping circuit. During stripping the pH value is maintained between 3.5 and 4.5 by the addition of gaseous ammonia. The stripped organic phase is washed with water in one stage to remove any entrained ammonium sulphate solution before recirculation to the extraction circuit or transfer to the regeneration system.

Regeneration of the organic phase is carried out by contacting a bleed stream with a 10% sodium carbonate solution in a single mixer settler.

Loaded stripping solution is pumped to yellow cake precipitation. Recently, a supplementary solvent extraction system was placed in operation to remove molybdenum before the yellow cake precipitation occurred. This new plant was necessary because the Deilmann ore contains more molybdenum than the Gaertner ore.

#### **12.5.4. Yellow cake precipitation and calcination**

Uranium contained in the pregnant strip solutions is precipitated with a mixture of gaseous ammonia and air in two vessels that operate in series at a pH value of 7.2. Yellow cake product slurry is then thickened. The thickener overflow is filtered through pressure precoating filters and recycled to the stripping operation. The thickener underflow is centrifuged and washed in two stages. Washed yellow cake is calcined at 750°C in a propane fired six hearth roaster.

#### **12.5.5. Ammonium sulphate crystallization plant**

To avoid any buildup, a bleed stream of the yellow cake thickener overflow is treated for ammonium sulphate removal. The removal circuit uses a quadruple effect evaporator-crystallizer unit with a production capacity of 2 t/h. The crystals are dried in a propane fired fluidized bed dryer.

#### **12.5.6. Neutralization of tailings pulp and liquids**

##### *12.5.6.1. Tailings pulp neutralization*

The washed pulps from the CCD circuit are neutralized with lime before being pumped to the tailings impoundment area. The Key Lake operation uses a subaerial tailings deposition technique. The arsenic, nickel and radium concentrations in the supernatant liquid exceed the regulatory discharge limits. These tailings dam waters are combined with other waste liquids and given further treatment as described in the next section.

##### *12.5.6.2. Liquids neutralization*

The solvent extraction raffinate together with the contaminated water from the mining operations, and the tailings dam water are first neutralized with lime to a pH value of 7 in a series of four pachuca tanks. After solid-liquid separation the solids are repulped with the neutralized leach residue stream and pumped to the tailings dam. The solution phase from the solid-liquid separation is treated with barium chloride and adjusted to a pH value of 11 to 12 with lime in a series of three agitated tanks. This treatment precipitates out the magnesium and the remaining traces of

arsenic and radium. The precipitate is collected in a thickener and combined with the first neutralization precipitate. The thickener overflow is adjusted to a pH value of 7, clarified, and held in monitoring ponds before final discharge to the environment.

#### REFERENCES

- [12.1] KEY LAKE STAFF, The Key Lake uranium process, paper presented at 19th Ann. Conf. Metallurgists, Canadian Institute of Mining and Metallurgy, Halifax, 1980.
- [12.2] NEVEN, M.J., Design of the Key Lake leaching process, paper presented at 12th Ann. Hydrometallurgical Mtg, Toronto, 1982.
- [12.3] MAYCOCK, A.R., NEVEN, M.J., "Design, construction, commissioning and operation of the Key Lake uranium mill", Extraction Metallurgy '85 (Proc. Symp. London, 1985), IMM, London (1985) 43-63. [Republished in Trans. Inst. Min. Metall., Sect. C Miner. Process. Extr. Metall. **96** (1987)].

## Chapter 13

### RABBIT LAKE

#### 13.1. INTRODUCTION

The Rabbit Lake uranium operation in Canada is located in north eastern Saskatchewan, 805 km north of Saskatoon. Originally discovered by Gulf Minerals Canada Limited in 1968, the mining operations commenced in 1975. The operation was purchased by Eldorado Nuclear Limited in 1982, which was subsequently merged in 1988 with the Saskatchewan Mining Development Corporation to form Cameco (Canadian Mining and Energy Corporation). Cameco also has major ownership in other uranium properties, including Key Lake Mining, as well as sizeable interests in the Cluff Lake uranium mine, Uranerz Exploration and Mining Limited, and in the Cigar Lake uranium mine. The production at Rabbit Lake in 1988 was 3130 t, thus accounting for almost one third of the uranium production in Saskatchewan.

During the operating period of the plant there have been a number of modifications to the metallurgical operation. This has been due to moving from a zone with one type of ore to other zones as the ores in the initial zones became depleted.

The following is a short summary of the plant and the modifications that have occurred as the feed type and mineralogy have changed. This description has been abstracted from 'The Rabbit Lake Story' [13.1-13.5]. The major portions have been taken from the papers on the milling and metallurgy, and those on the environmental aspects.

#### 13.2. MILL CIRCUIT AND FEED TYPES

Initially the mill processed the ore from the first deposit, the Rabbit Lake material, followed by the B zone ore in 1985. Other zones for future processing are the A zone, D zone and Eagle Point. The mineralogy and chemical analyses comparisons of the Rabbit Lake and the B zone ores are given in Tables 13.1 and 13.2. Because of the considerable differences in the mineralogy and the chemical composition, the initial process, developed for the treatment of the Rabbit Lake ore, had to be modified to treat the later, more complex material (owing to the presence of arsenic, nickel and molybdenum, and lower levels of carbonate). Therefore, the following description is essentially that of the present circuit, with some referral being made to the original circuit.

TABLE 13.1. COMPARISON OF RABBIT LAKE AND B ZONE MINERALOGY

Rabbit Lake	B zone
Uranium minerals	Uranium minerals
colloform pitchblende	pitchblende
sooty pitchblende	coffinite
uranophane	
Gangue minerals	Gangue minerals
kaolinite	sericite
dickite	kaolinite
vermiculite	chlorite
sulphides (minor)	niccolite (major)
	millerite
	galena
	chalcopyrites
	pyrite
Host rock	Host rock
siliceous dolomite	sandstone

TABLE 13.2. CHEMICAL ANALYSES OF RABBIT LAKE AND B ZONE ORES

Species	Typical Rabbit Lake ore (%)	B zone ore (%)		
		Average grade	High grade	Low grade
U <sub>3</sub> O <sub>8</sub>	0.37	0.62	15.0	0.28
Arsenic	0.003	0.47	10.2	0.49
Nickel	0.014	0.35	8.27	0.49
Molybdenum	0.002	0.01	0.12	0.015
Iron	—	3.11	1.94	1.20
Vanadium	0.021	0.021	0.12	0.047
Sulphur	—	0.07	—	—
Phosphate	0.016	0.02	—	—
Carbonate (as CO <sub>2</sub> )	2-3	0.20	0.29	0.04

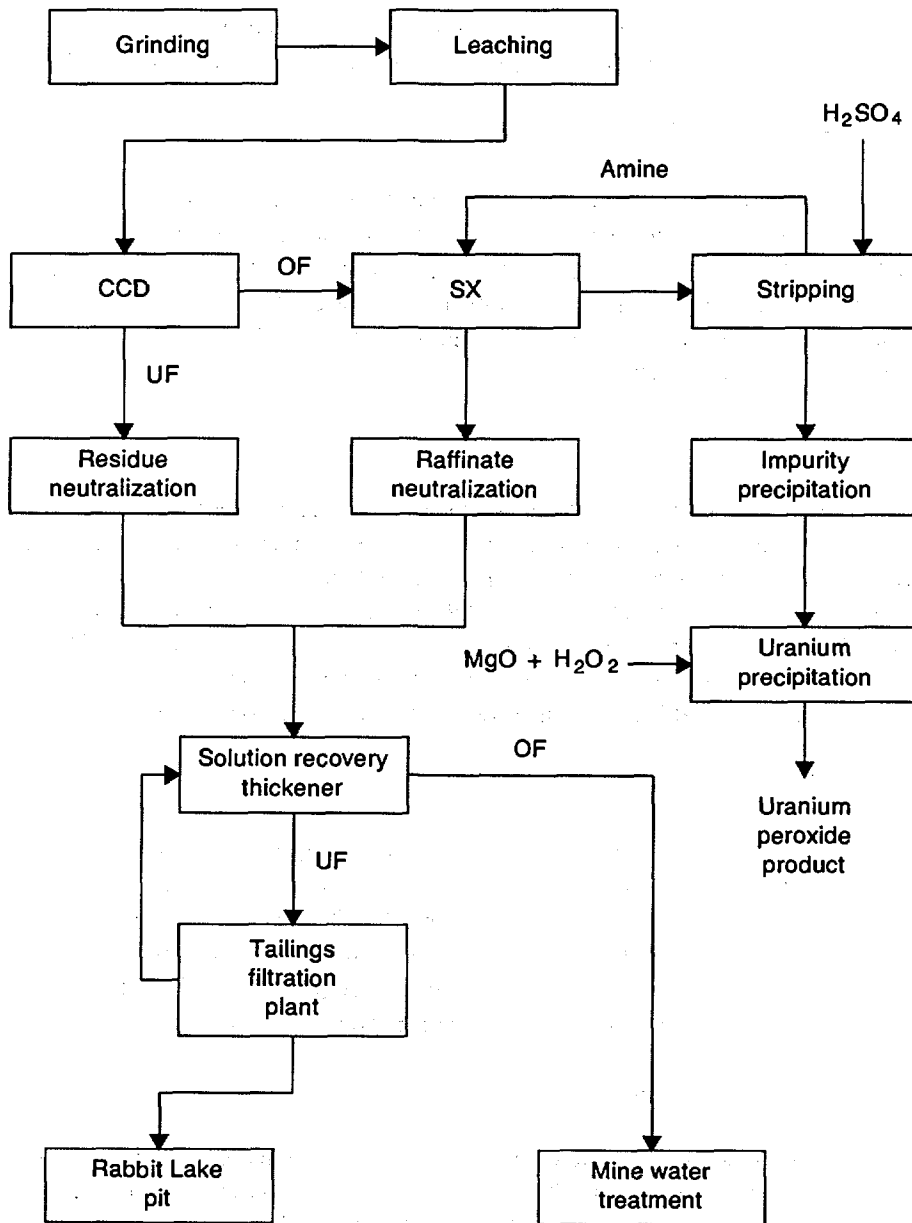

FIG. 13.1. Schematic flow sheet of process at Rabbit Lake: OF, overflow, UF, underflow.

### 13.3. FLOW SHEET OF THE PROCESS

The schematic flow sheet of the present process at Rabbit Lake is shown in Fig. 13.1. Descriptions of the unit operations are given in the following sections.

#### 13.3.1. Ore preparation

Production commenced in mid-1975 with the Rabbit Lake material. The mill was designed for a throughput of 1.5 kt per day or 480 kt annually at an average grade of 0.44%  $U_3O_8$  to produce 2 kt  $U_3O_8$  per year. Following crushing and autogenous grinding (the less friable Rabbit Lake ore used semiautogenous grinding), and cycloning, the cyclone overflow portion (45%  $-75 \mu m$  at 55% solids) is sent to the leaching circuit.

#### 13.3.2. Leaching

The thickened pulp is stored in two mechanically agitated tanks, and adjusted to a pH value of 1.5 to 2.0 with sulphuric acid. The leaching is completed in seven stages, with the addition of sulphuric acid and sodium chlorate to maintain a pH value of 1.5, and a terminal EMF of  $-450$  to  $-500$  mV (platinum and saturated calomel electrodes). The free acid concentration is 25 g/L. A temperature of  $55^\circ C$  is maintained by sparging with steam. The uranium recovery is 93%. The sulphuric acid consumption is 70 kg/t, and the sodium chlorate consumption is 15 to 20 kg/t.

#### 13.3.3. CCD

Following leaching the discharge is sent to a six stage CCD circuit, each thickener being 30.5 m diameter and lined with glass fibre. The washing solution is raffinate or fresh water, at a washing ratio of 2.5. The underflow density is 50%, and the amount of flocculant added is 0.15 kg/t. The pregnant solution is clarified in a 18.3 m diameter by 5.5 m deep clarifier and surge tank and is then pumped through four 2.1 m diameter by 3.7 m long pressure sand filters.

#### 13.3.4. Solvent extraction

The clarified pregnant solution is purified, and the uranium content upgraded, in a solvent extraction circuit. The solvent composition consists of a mixture of 3.5 vol.% tertiary amine, 3.5 vol.% isodecanol and 93% kerosine diluent, and the solvent temperature is  $27^\circ C$ . In the original circuit, treating the Rabbit Lake ore feed, extraction was in four stages of mixer settlers (Lightnin pump mixer) with internal organic recycling in extraction; aqueous recycling was used in stripping and regeneration. The mixer settlers were originally constructed of urethane lined

concrete, but the urethane failed and was replaced with glass fibre. Each extraction mixer tank has a working volume of 7000 L, while each of the stripping and regeneration tanks are of 12 000 L. The area of the extraction settlers is 100 m<sup>2</sup>, while the area of the stripping and regeneration settlers is 50 m<sup>2</sup>. The stripping solution was a 130 g/L ammonium sulphate solution, and the pH value was controlled at between 4.0 and 4.3 with ammonia. The regenerating solution was 5% sodium carbonate solution. Some raffinate was recycled to the leaching stage to help reduce the sodium chlorate consumption.

When the B zone ore was fed to the process some major modifications were necessary in the solution purification circuit. The extraction circuit remained unchanged. Early tests on the feed solution resulted in serious crud formation, much higher than that experienced with the Rabbit Lake ore. In addition, if ammonia was to be used in the stripping stage, an ammonia removal process was considered to be necessary in order to meet the 15 ppm U target in the effluent discharge. The stripping operation was, therefore, converted to a strong sulphuric acid process (425 g/L), using five stripping stages. To overcome corrosion the pumps are lined with glass fibre and Buna N. The single stage regeneration step remained a part of the new circuit.

After a few months of operation with the B zone feed, serious problems, such as the following, arose in the solvent extraction circuit:

- (a) At a high stripping acid concentration the operating temperature had to be kept below 40°C to prevent degradation of the tertiary amine.
- (b) Recycling the raffinate, which contains impurities such as molybdenum, could produce precipitate cruds in the stripping circuit.
- (c) The tertiary amine degraded rapidly at a high oxidation potential because of the excessive amounts of sodium chlorate being added in the leaching process.

#### 13.3.5. Impurity removal from the stripping liquor

Although the solvent extraction circuit rejects most impurities, nevertheless a few impurities remain with the uranium in the stripping solution and require removal:

- (1) *Zirconium*. Provision was made to remove zirconium by the addition of phosphoric acid to affect the precipitation. However, the levels of zirconium have been lower than anticipated, and this stage has not been required.
- (2) *Arsenic*: Ferric sulphate may be added to precipitate the arsenic.

#### 13.3.6. Two stage precipitation

The solvent extraction stripping solution is adjusted to a pH value of 3.5 with milk of lime to produce a precipitate of mainly gypsum, which is thickened, vacuum



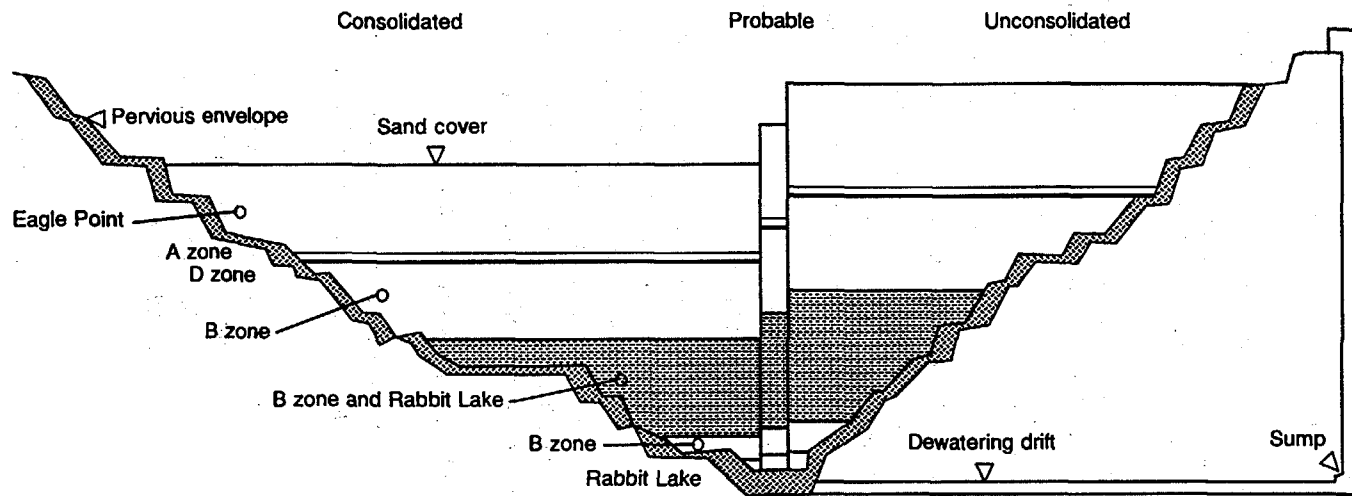

FIG. 13.2. Rabbit Lake in-pit tailings disposal cross-section (not to scale).

drum filtered, and the solids returned to the CCD circuit for uranium recovery. The filtrate is sent on to the precipitation circuit for uranium precipitation.

In the original precipitation circuit the stripping liquor containing the uranium product was treated with ammonia in two stages (pH7.3 to pH8.2) at a temperature of 60 to 70°C. The precipitated ammonium diuranate product (yellow cake) was thickened in glass fibre lined mild steel (formerly urethane lined) thickeners and washed. The washed cake was then dewatered to 55 to 60% solids in a 316 SS Bird centrifuge (46 cm diameter by 97 cm long).

With the new feed material the precipitation circuit has also changed. Precipitation is now carried out in four agitated glass fibre tanks in series. Magnesia is added to a controlled pH value of 3.5 and hydrogen peroxide (0.25 kg/kg  $U_3O_8$ ) is then added to recover the uranium as uranium peroxide. The pH value of the discharged material is 3.7. The precipitate is washed in two thickeners and then pumped to a Bird centrifuge.

### 13.3.7. Calcining

In the original plant the yellow cake was calcined at about 650°C in a diesel fuel fired multihearth roaster (of 5 m diameter with six hearths). The dried product was passed through a hammer mill to produce a -0.6 mm material.

In the new circuit the dryer is a Bethlehem 'Porcupine' model, which consists of a jacketed vessel with an internal, heated rotary screw. Heating is provided by a circulating flow of Monsanto Therminol 59 heat transfer oil. The centrifuge cake, at about 60% solids, is discharged into the inclined recycling screw, which also carries a recycling load of hot, dried product. The dryer discharge temperature is 110°C.

The off-gases from the dryer contain only water vapour because the dryer is not directly fired. Dusting is minimal, and three Ducon scrubbers collect any dust contaminated gases from the drying and packaging areas. The scrubber water is returned to the uranium peroxide washing circuit.

## 13.4. TAILINGS MANAGEMENT

In the original plant the underflow from the last stage CCD circuit, together with the bleed streams, was pumped to a two stage neutralization circuit where a lime slurry was added to adjust the pH value to 7.2. The resulting slurry was discharged to the tailings pond.

Major modifications were necessary with the processing of the B zone ore, which contains more impurities. The solvent extraction raffinate, together with any other solutions, are neutralized with slaked lime in a series of four steel air agitated Pachucas. The pH value is controlled at 10.2 in order to assure precipitation of the

nickel and most of the arsenic. The solid waste (essentially CCD tailings) is neutralized with lime in similar Pachucas. Again a pH value of 10.2 is maintained. The lime consumption is 15.5 g/L of the solution. The neutralized streams are sent to a new tailings filtration plant. Following filtration on five 3.2 m diameter by 12 disc Eimco agidisc filters, the filter cake is repulped with the neutralized tailings slurry and the combined streams discharged into the mined out Rabbit Lake pit.

The filtrate from the neutralization, together with the mine water from the B zone pit, is sent to a 30.5 m diameter glass fibre lined steel thickener unit in the mill. The underflow, containing some uranium from the mine water, is recycled back to the process for recovery:

The overflow is sent to the mine water treatment circuit. This circuit consists of four steel tanks in series, with air sparging and mechanical agitation. Sulphuric acid is added to the first tank to lower the pH value to 7.0. In the second tank ferric sulphate is added to complete the removal of any arsenic that is still present. In addition, barium chloride is added to co-precipitate the barium-radium sulphate. Lime is added to a controlled pH value of 8.5 in the other two tanks.

The resultant low density slurry is pumped to a settling pond, and the overflow is again treated in a new effluent treatment facility for the removal of residual radium. The treatment consists of adding barium chloride, lime and a flocculant to promote the settling of the precipitate that forms. This precipitate is discharged to a second pond, where the overflow from that pond is polished by passing through pressure sand filters before being released to the environment.

The tailings impoundment, like the milling process, has changed with time. Originally, during the processing of the Rabbit Lake ore, the impoundment area consisted of earth filled dams constructed across an elongated valley. The dams were constructed in stages during the operation, maintaining a freeboard height of 6.1 m above the water level, and a final height of 1.22 m. Raising the levels was by the downstream method, i.e. tailings slurry was discharged at the perimeter, with periodic movement of the discharge point. Water was removed by a floating pump station.

Before the new B zone ore was to be processed the decision was taken to discharge the filtered tailings into the mined out Rabbit Lake pit. There was insufficient room in the previous impoundment area, and the pit would be available. This disposal option has been very successful. Such a disposal system, indicated diagrammatically in Fig. 13.2, has the following features:

- (a) Tailings consolidation during placement is enhanced as the pore water is drained out.
- (b) Total containment and collection of the pore water for monitoring and treatment are provided.
- (c) The hydraulic gradients in the underground environment are low.
- (d) The integrity of the depository is maintained.

**REFERENCES**

- [13.1] BABCOCK, M.R., The Rabbit Lake story, CIM Bull. (Dec. 1989) 37-39.
- [13.2] WARD, D.M., Rabbit Lake project — history of exploration and general geology, CIM Bull. (Dec. 1989) 40-48.
- [13.3] CLARK, G.W., Rabbit Lake project — mining and development, CIM Bull. (Dec. 1989) 49-58.
- [13.4] PHILLIPS, R.L.J., Rabbit Lake project — environmental impact, CIM Bull. (Dec. 1989) 59-68.
- [13.5] MILDE, W.W., Rabbit Lake project — mining and metallurgy, CIM Bull. (Dec. 1989) 69-75.



## Chapter 14

### LODEVE

#### 14.1. INTRODUCTION

The Lodève deposits are located in the southern part of France, sixty kilometers north of the Mediterranean coast between the towns of Lodève and Clermont l'Hérault. The first discovery was made in 1957, and exploration drilling was carried out until 1974. The decision to proceed with mining was made at this date. Mining operations, which are conducted by Compagnie générale des matières nucléaires (Cogéma), began in 1975. The mill, which is also operated by Cogéma through its 100% owned subsidiary Société industrielle des minerais de l'ouest (SIMO) started production at the end of 1981. The nominal mill capacity is 4.0 Mt/a of ore; this feed rate produces about 1000 t of uranium per year with a uranium recovery of 94%. From a metallurgical point of view, the Lodève process can be qualified as a complex alkaline process for a complex type of ore.

#### 14.2. GEOLOGY AND RESOURCES

The Lodève deposits are located in the lower part of a Permian sedimentary basin, which includes mineralized grey autunian covered by sterile red saxonian. In 1980 the reserves were assessed at 20 kt of uranium with the ore grade exceeding 0.2% U.

Among the autunian shale or siltstone stratas, more than sixty are blackened with organic matter and can be considered as favourable for uranium deposition. Uranium is present either as a diffused submicroscopic mineralization or as short veins where pitchblende is associated with bituminous matter. Near large faults these veins can extend to form rich stockwork type accumulations.

#### 14.3. MINERALOGY

The concentration of carbonates is high, lying between 6 and 10% of CO<sub>2</sub>. The mineralization is essentially ankerite, a ferriferous dolomite. This high carbonate concentration dictated the choice of an alkaline processing technology.

The ore also contains a significant concentration of phyllosilicates, including illite and montmorillonite. These minerals are chemically inert in an alkaline medium, but their fragility, especially when finely ground, leads to solid-liquid

separation problems. Sulphides are also present, primarily as pyrite, but part of the sulphur content of the ore may be associated with organic matter. The average sulphur content lies between 0.6 and 0.8%. Various attempts at flotation of the sulphides did not produce satisfactory separations; the recoveries never exceeded 50%.

The inability to separate out the sulphides has two consequences for the process:

- (a) Inevitable production of sodium sulphate,
- (b) Greater difficulty in dissolving the uranium.

The ores also contain molybdenum. On the average, the Mo:U ratio is about 1:10, but in certain zones may reach 1:4. This molybdenum, which leaches along with the uranium, is recovered as an impure molybdenum sulphide concentrate.

Zirconium is also present. Its concentration is low, the Zr:U ratio varying from about 1:100 up to 1:30. If not removed, all of the dissolved zirconium turns up in the final concentrate.

Organic matter is also present in the ore; the organic carbon content can reach 1%. During leaching, organic matter dissolves and produces black liquors that are rich in substances similar to alkaline humates. The organic matter can interfere with the leaching operation because some of the organic compounds have surface active properties. By using pure oxygen, and thus avoiding the large flow of inert gas (N<sub>2</sub>) that would be associated with the use of air as the oxidant source, it was possible to limit the likelihood of emulsification and foaming in the leaching autoclaves. However, at the same time, the formation of hydrogen and carbon monoxide requires continuous monitoring and renewal of the autoclave atmosphere.

The presence of the following six particular constituents:

- (1) Carbonates,
- (2) Phyllitous matter,
- (3) Sulphides,
- (4) Molybdenum compounds,
- (5) Soluble zirconium,
- (6) Organic matter.

led to a complex process, which is described in Section 14.4.

#### 14.4. MILLING

The Lodève mill uses a two stage carbonate leaching circuit followed by two stages of yellow cake precipitation; the overall flow sheet is shown in Fig. 14.1.

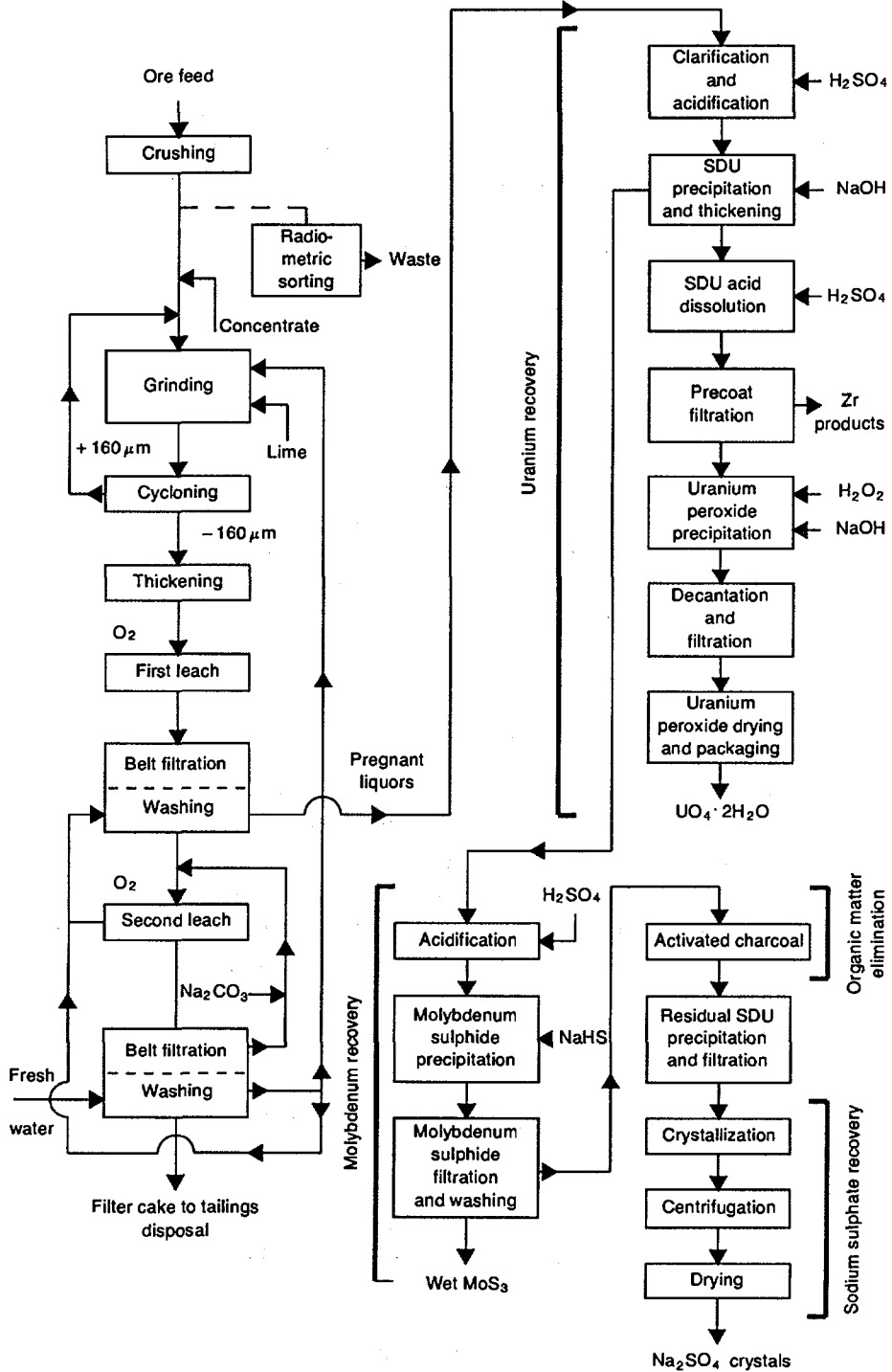

FIG. 14.1. Schematic flow sheet of process at Lodève (SDU, sodium diuranate).



#### 14.4.1. Size reduction

Raw ore is first crushed to a size of  $-300$  mm in a primary jaw crusher, which is located underground. Secondary and tertiary crushing are carried out in the surface facilities using a two stage gyratory crusher circuit operated in closed circuit with 20 mm screens. The  $-20$  mm ore is fed to an open circuit rod mill that is followed by a ball mill operated in closed circuit with a cyclone. The ground ore slurry (95%  $< 160$   $\mu\text{m}$ ) is then thickened to 50% solids in a 25 m diameter thickener.

#### 14.4.2. Ore sorting

A model 17 (Section 4.3.3.2) radiometric ore sorter unit was installed in the crushing section and put into operation in mid-1985. The  $-90$  mm  $+30$  mm fraction of the product from the primary crusher is fed to the radiometric sorter; this fraction constitutes approximately 40% of the total ore feed. The accept product from the radiometric sorter plus the unsorted ore fraction represents 85% of the total ore tonnage; the uranium recovery is 98%.

#### 14.4.3. Leaching and solid-liquid separation

The first stage leaching operation is carried out in six autoclaves operated in series. The leaching conditions are 3 h at  $140^{\circ}\text{C}$  under an oxygen pressure of 0.6 MPa. After flocculation with polyethylene oxide the leached pulp is filtered on two parallel  $40\text{ m}^2$  belt filters. The filter cake is washed with the wash-water filtrate from the second stage filtration. The pregnant liquors from the first stage filtration are treated for uranium recovery, molybdenum recovery, organic matter elimination and sodium sulphate crystallization.

The first stage filter cake is repulped with the pregnant liquors from second stage filtration, which have been enriched with sodium carbonate. This pulp is pumped to the second stage leaching circuit that consists of twelve autoclaves operated in series. Here the ore is leached for 6 h, at  $140^{\circ}\text{C}$  under 0.6 MPa of oxygen pressure. The second stage filtration is carried out on four parallel  $40\text{ m}^2$  belt filters. As mentioned above, the first portion of the pregnant liquors from the second stage filtration is recycled for repulping the filter cake from the first stage filtration. This closed loop operation makes it possible to attain the strong sodium carbonate concentrations required for high uranium solubilization. Fresh water is used for the final washing of the filter cake. Depending on their concentration the filtrates from this final washing operation are recycled to either the first stage filtration wash or to the ore grinding circuit.

#### 14.4.4. Uranium precipitation

After clarification through sand filters the pregnant liquors are first acidified to a pH value of 5 for carbon dioxide elimination. Uranium contained in these liquors is then precipitated with sodium hydroxide at a pH value of 11.5. The precipitate is a mixture of sodium diuranate (SDU) and uranium hydroxides. After thickening, this precipitate is redissolved with sulphuric acid at a pH value of 3. The uranium redissolves, but the zirconium compounds and other impurities remain insoluble and are removed on a precoating filter. Uranium contained in the filtrate is precipitated in a continuous circuit with hydrogen peroxide. The precipitation conditions are 4 h at 30°C with an addition of caustic soda to control the pH value at about 3.5. The resulting yellow cake precipitate is thickened, filtered on a belt filter and finally dried in a spray dryer.

This process started operation in September 1984. From 1981 to 1984 another process was used, which did not give full satisfaction because of yellow cake purity problems (zirconium mainly, but also calcium, sodium and silica). The previous process included precipitating the uranium as a calcium uranate using lime, roasting the precipitate to burn the organic material, dissolving the roasted product in sulphuric acid, filtering out the calcium sulphate and precipitating the uranium with magnesia to produce a magnesian diuranate.

The new process not only eliminated the purity problem but also significantly reduced the quantity of liquid waste. Previously, the magnesian uranium thickener overflow containing mainly sodium sulphate and magnesian sulphate was discharged without treatment. In the new process the uranium peroxide thickener overflow contains only sodium sulphate. Not only is the liquid waste discharge eliminated, but, moreover, the sodium sulphate is recovered as a saleable by-product.

#### 14.4.5. Molybdenum recovery

The overflow from the SDU and uranium hydroxide thickener is first concentrated by evaporation by a factor of about eight. Next, the concentrated solution is acidified to a pH value of 2.5 with sulphuric acid; this adjustment converts the sodium molybdate to molybdic acid. Molybdenum trisulphide is then precipitated by adding hydrogen sodium sulphide and holding the temperature at 55°C for two hours. This precipitate is filtered on a press filter and finally washed on a belt filter to lower the sodium sulphate content before drumming as a wet precipitate.

#### 14.4.6. Organic matter elimination

To obtain sodium sulphate crystals that meet market specification whiteness the solutions obtained from the molybdenum sulphide filtration are treated with powdered activated charcoal to eliminate organic matter and residual molybdenum

sulphide. The reaction is carried out in a two tank series at 55°C with a 30 min contact time.

Currently, partial chemical regeneration of the charcoal is achieved by treating the charcoal with sodium hydroxide. The treated charcoal is then filtered, washed and recycled. Thermal regeneration in a screw type furnace at 550°C has been studied and will soon be put into operation.

#### 14.4.7. Sodium sulphate recovery

The product liquors from the activated carbon treatment contain several tens of ppm of uranium. The market specification for the sodium sulphate product requires that the sodium sulphate product does not exceed several ppm U. To meet this requirement the last traces of uranium are precipitated with sodium hydroxide at a pH value of 8.5 and the precipitate removed by filtration. After filtration the treated solution passes through a heat exchanger to an evaporator-crystallizer where the sodium sulphate crystallizes as  $\text{Na}_2\text{SO}_4 \cdot 10\text{H}_2\text{O}$ . The crystals are centrifuged and dried in a hot air dryer before shipment.

#### 14.4.8. Tailings management

The initial operations at Lodève used open pit mining. After the near surface reserves were exhausted, underground mining was adopted; these works are still in operation. The open pit mining operations began before ore milling, and from the beginning of the milling operations, the tailings were deposited in the open pit. The tailings are filtered and then transported to the open pit on conveyor belts. As sections of the open pit are filled the waste rock is bulldozed over the tailings and the surface revegetated.

### REFERENCES

- [14.1] BODU, R., et al., "The Lodève mill; a complex alkaline process for a complex uranium ore", MINTEK 50: Int. Conf. on Recent Advances in Mineral Science and Technology (Proc. Int. Conf. Santon, South Africa, 1984), Council for Mineral Technology, Randburg (1984).
- [14.2] LYAUDET, G., MICHEL, P., MORET, J., WINTER, J.M., "A new unit for purification of uranium solutions in the Lodève mill", Development of Projects for the Production of Uranium Concentrates (Proc. Tech. Committee Mtg Vienna, 1985), IAEA, Vienna (1987) 55-67.
- [14.3] GRENIER, J., WINTER, J.M., DEVILLE, P., Installation d'un triage radiométrique sur le complexe minier, Rev. Ind. Miner. (June 1986) 259-265.

## Chapter 15

### ROSSING

#### 15.1. INTRODUCTION

Rossing Uranium Ltd is a fully owned subsidiary of the RTZ Corporation. It is currently the only uranium producer in Namibia and is the second largest uranium producer in the world, after Key Lake in Canada. The Rossing orebody is located in the Namib Desert, 65 km north east of Swakopmund on the Atlantic Coast of Africa. It is 12 km from the town of Arandis, which was created to house Rossing's employees. The Namib Desert runs the entire 1300 km length of the west coast of Namibia.

The uranium mineralization at Rossing was discovered in 1928. The systematic exploration of the Rossing orebody started in 1966. The decision to go ahead was made in 1973, after completion of a comprehensive feasibility study. Construction began in July 1974, and production started in 1976, but many severe problems had to be overcome. Many operating difficulties were caused by the abrasive nature of the host rock; there were also a number of design and engineering deficiencies. The fully rated capacity of 4.54 kt of  $U_3O_8$  per year was attained in 1979. A peak milling capacity of  $1.64 \times 10^7$  t/a was attained in 1980. In 1991 production was reduced to 3.63 kt of  $U_3O_8$  because of prevailing market conditions.

#### 15.2. GEOLOGY AND MINERALOGY

Arenaceous sediments of the Nosib Group were emplaced onto an Archaean basement and subsequently overlain by pelitic and chemical sediments of the Swakop Group. These Groups make up the Damara Supergroup and were subjected to high-grade metamorphism during the 500–600 Ma pan-African Event. Extensive granitization and granitic intrusion occurred. The red granite–gneiss suite, derived from both the basement and Nosib rocks, was thus formed. Although these granites may contain anomalous concentrations of uranium, it is the late phase differentiation of the red granite–gneiss suite, namely alaskitic granites, which host the uranium mineralization. In all cases the deposits are associated with anticlinal or dome-like structures. Their sizes and grades have largely been controlled by the first marble band in the Swakop Group, which acted as a trap for the intrusive alaskites.

The Rossing deposit is about 3 km long and 3 km wide; it is the largest known uranium deposit occurring in granite. It occurs in a migmatite zone in which the uraniumiferous alaskitic granite and metamorphosed country rock show various concordant, discordant and gradational relationships.

The principal uranium mineral is uraninite, although some betafite and beta uranophane are also present. Uranium mineralization occurs as inclusions in quartz, feldspar and biotite as well as interstitially in these minerals or along cracks within the grains. The uranium concentrations in the Rossing deposit are erratic and may range from trace amounts to 1.0%  $U_3O_8$ .

### 15.3. MINING

Mining is by the open pit method using 15 m benches. The mining equipment used includes five rotary drills with 380 mm drill bits, six shovels, either hydraulic or rope operated with 14.86 m<sup>3</sup> or larger capacity buckets, and 36 trucks for haulage.

The blast holes are 380 mm in diameter and 18 m deep. Each blast hole has a charge of about 1600 kg of ammonium nitrate based explosive placed in it. The broken ore is loaded with face shovels into electrically driven 150 t haulage trucks. Water is used to suppress the dust in the open pit and at various crushing stages. The trucks are scanned radiometrically to determine the grade of the material in each truck. This measurement determines if the truck load is crusher feed, waste or low grade ore for stockpiling. Careful ore blending is required to give a consistent mill feed.

The mineable reserves at Rossing are estimated to be 150 kt of  $U_3O_8$ , contained in 411 Mt of ore. The total amount of material to be mined is 1.2 Gt.

Current mine production is 40 Mt of total materials per year. The maximum annual production, which was attained in 1982, was 61 Mt of ore and mine waste.

### 15.4. MILLING OPERATIONS

The Rossing mill uses an acid leaching ion exchange process; the general flow sheet is shown in Fig. 15.1.

#### 15.4.1. Crushing and grinding

Four stages of crushing and one stage of wet grinding are used. Two primary gyratory crushers reduce the as mined ore to sizes of less than 160 mm. This product is sent to a coarse ore storage area, which has a capacity of 70 000 t. Ore is recovered from the stockpile and fed to the fine crushing plant where it is reduced by secondary, tertiary and quaternary crushers to a size of less than 19 mesh (850  $\mu m$ ), and then sent to the grinding circuit.

Grinding is in one stage in four 4.4 × 6.1 m<sup>2</sup> overflow rod mills charged with 100 mm diameter rods. The rod mill pulp density is maintained at 75 to 76%

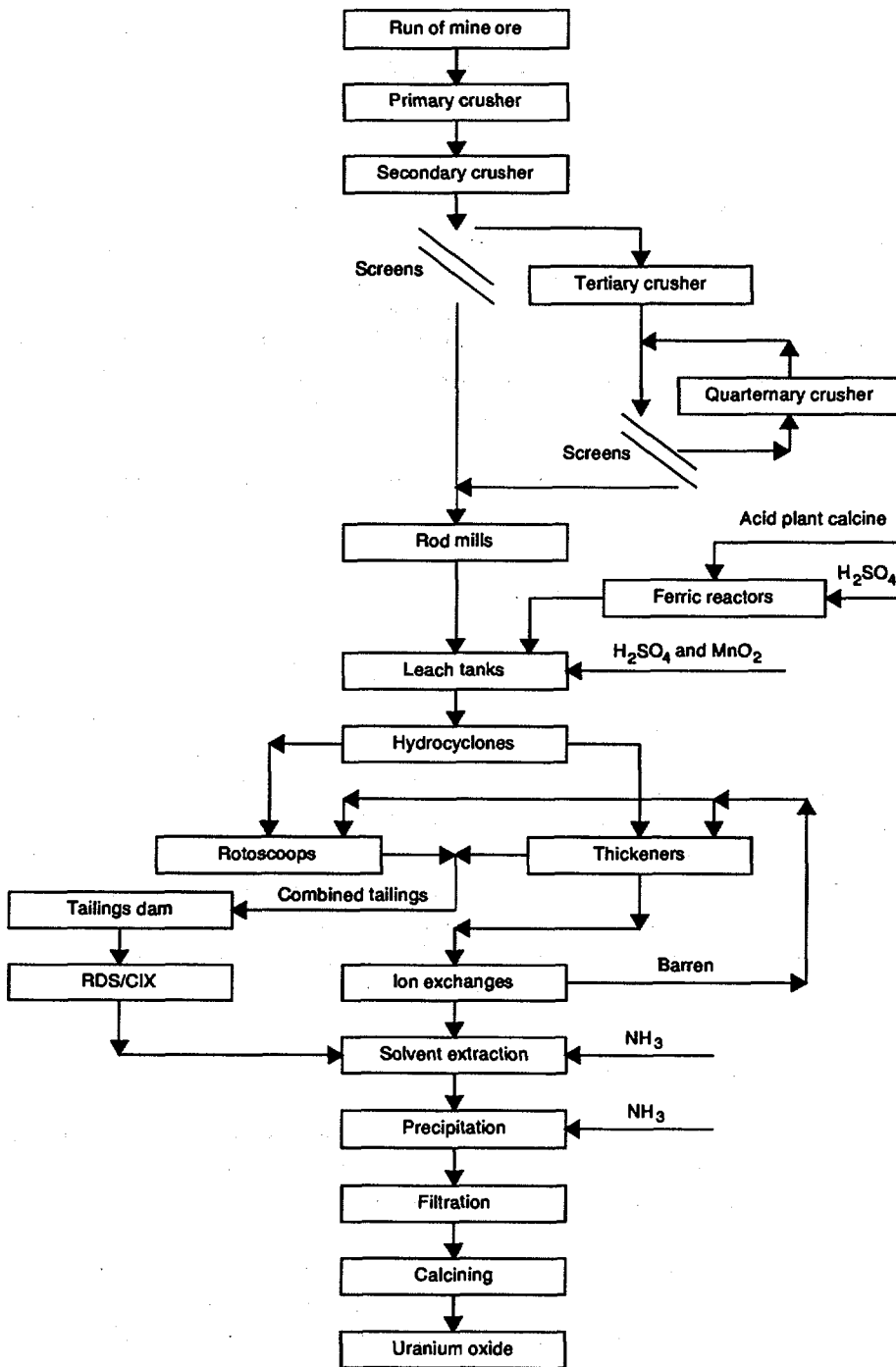

FIG. 15.1. General flow sheet of metallurgical process at Rossing (RDS, recycled decant solution).

solids. This density is adjusted using water at 45°C, thereby raising the pulp temperature in preparation for the leaching operation.

#### 15.4.2. Leaching

The leaching is carried out with sulphuric acid, using ferric sulphate and manganese dioxide as oxidants. The ground pulp is fed to a 291 m<sup>3</sup> mixing tank to which some two thirds of the required acid is added. This addition increases the temperature of the pulp to about 49°C. The pulp then flows through a series of five additional tanks, each with a volume of 1400 m<sup>3</sup>. The solids are maintained in suspension using a 1.5 m diameter impeller driven by a 260 kW motor. The total residence time is about 9.5 h. Under these conditions 90% of the uranium contained in the ore is extracted.

Rossing has its own acid plant, based on the roasting of pyrites produced from the Otjihase mine in Namibia.

#### 15.4.3. Solid-liquid separation

The leached pulp is diluted using overflow solution from the first state of the Rotoscoop circuit (described below) and then separated into coarse and fine fractions using ten 660 mm diameter hydrocyclones. The cyclone overflow is sent to a five stage CCD thickener circuit. The overflow from the first stage of the CCD circuit is the pregnant feed liquor for the ion exchange plant. The thickener underflow from the fifth stage of the CCD circuit discharges to the tailings dam.

The cyclone underflow is washed in a two stage Rotoscoop circuit. These units provide suitable conditions for the settlement of the coarse solids that are picked up by the ploughs attached to the underside of a rotating table and are then discharged down a chute to the next processing stage. The washed sands from the Rotoscoop circuit are also discharged to the tailings disposal area.

#### 15.4.4. Concentration and purification

The pregnant solution is purified and concentrated in a CIX. The ion exchange plant has a total rated capacity of about 3600 m<sup>3</sup>/h. Elution is carried out in a three column system of the moving-bed type (see Section 7.2.3.2) using 10% sulphuric acid as the eluent.

The eluate is fed to an amine solvent extraction circuit that contains five extraction stages, two scrubbing stages, four stripping stages and a single solvent regeneration stage. The extraction stages run in an aqueous continuous mode with an aqueous-to-organic ratio of 1:1.6. The loaded organic is scrubbed with water and stripped with gaseous ammonia.

#### 15.4.5. Product recovery

The pregnant liquor from the solvent extraction plant contains some 8.5 to 10 g/L of  $U_3O_8$ . Ammonium diuranate is precipitated from this solution by raising the pH value to 7.5 with gaseous ammonia. The precipitate is thickened in a 18 m diameter thickener, and then washed in a two stage filtration circuit with intermediate repulping. The washed yellow cake is calcined in a six hearth roaster and packed in steel drums for shipping. The product meets the relevant specifications and has a  $U_3O_8$  content of about 98%.

#### 15.4.6. Tailings disposal

The Rossing plant generates approximately 80 000 m<sup>3</sup> of tailings per day, containing 40 000 t of solids. The washed pulp is pumped through 450 mm pipelines to the tailings area located in a nearby valley, across the mouth of which a dam has been constructed. Most of the overflow liquid from the tailings dam is recycled to the plant.

### BIBLIOGRAPHY

- BATES, M.P., "Namibia's uranium production", Uranium and Nuclear Energy 1989 (Proc. 14th Int. Symp. London, 1989), Uranium Institute, London (1989).
- BEALE, C.O., OLDSHUE, J.Y., STERNOD, G., "Mining and leaching in 1400 m<sup>3</sup> tanks at Rossing", Hydrometallurgy (Proc. 3rd Int. Symp. Atlanta, 1983), Metallurgical Society of the AIME, New York (1983).
- BERNING, J., COOKE, R., HIEMSTRA, S.A., HOFFMAN, U., The Rossing uranium deposit, South West Africa, Econ. Geol. 71 (1976) 351-368.
- CUNEY, M., Preliminary results on the petrology and fluid inclusions of the Rossing uraniumiferous alaskites, Trans. Geol. Soc. S. Afr. 83 1 (1980) 39-45.
- FREEMAN, G.M., VERNON, P.N., "Technical and human considerations in the development of the Rossing uranium mine", paper presented at 13th CMMI Congr., IMM, London, 1986.
- INTERNATIONAL ATOMIC ENERGY AGENCY, Significance of Mineralogy in the Development of Flowsheets for Processing Uranium Ores, Technical Reports Series No. 196, IAEA, Vienna (1980) 225.
- KNOWLES, A., Mine Design at Rossing, Thesis, University of Nottingham, UK (1988).  
Rossing uranium, Min. Mag. (Nov. 1978).
- NUKEM, Uranium Producer Profile, Market Rep. No. 9, NUKEM (1984) 8.



NUCLEAR ENERGY AGENCY OF THE OECD, INTERNATIONAL ATOMIC ENERGY AGENCY, Uranium Extraction Technology: Current Practice and New Developments in Ore Processing, OECD/NEA, Paris (1983) 207-211.

ROSSING URANIUM LIMITED, The Rossing Fact Book, Rossing Uranium Limited, Windhoek, Namibia (1989).

SANDY, D.A., Drill, load, and haul practices at Rossing mine, Namibia, Trans. Inst. Min. Metall., Sect. A Min. Ind. **98** (1989).

VERNON, P.N., SMIT, M.T.R., "Engineering and metallurgical improvements at the Rossing uranium treatment plant", Separation Processes in Hydrometallurgy (DAVIS, G.A., Ed.), Ellis Horwood, London (1987).

WYLLIE, R.J.M., Rossing uranium reaches full production, World Min. (Jan., Feb. 1979).

## Chapter 16

### COMINAK

#### 16.1. INTRODUCTION

A large uraniferous area was discovered during the 1960s by Commissariat à l'énergie atomique geologists in a desert region in the north west of the Republic of Niger in the province of Agadès. The first mining and milling operation began in 1971, at the SOMAIR (Société des mines de l'Air) location. The Cominak (Compagnie minière d'Akouta) operation, which started production in the summer of 1978, is located about 10 km from the SOMAIR site. The shareholders are the Republic of Niger, the Compagnie générale des matières nucléaires, a consortium of Japanese companies called OURD (Overseas Uranium Resources Development) and ENUSA, a Spanish company.

The mill now produces about 2 kt of uranium as a magnesian uranate from 0.46 Mt of ore. The ore grade is 0.45% U, and nearly 94% of the uranium is recovered.

#### 16.2. GEOLOGY

The Akouta deposit lies principally in fluvio-deltaic sedimentary sandstones as stratiform mineralizations at a depth of 250 to 300 m. Some argillaceous beds from one to several metres thick can be found locally with the sandstones.

#### 16.3. MINERALOGY

The uranium bearing sandstone is composed of quartz grains varying from 0.1 to 0.6 mm in size. Uranium is present both as microscopic pitchblend particles that coat the quartz grains and as microscopic coffinite dispersed in the chloritic cement. Pyrite quite frequently occurs as centimetric to decimetric beds. In the mineralized zones, pyrite can be accompanied by high local concentrations of uranium and molybdenum.

#### 16.4. MINING AND MILLING

The Cominak operations use underground mining methods and an acid pugging-solvent extraction recovery process. Figure 16.1 shows the overall milling flow sheet.

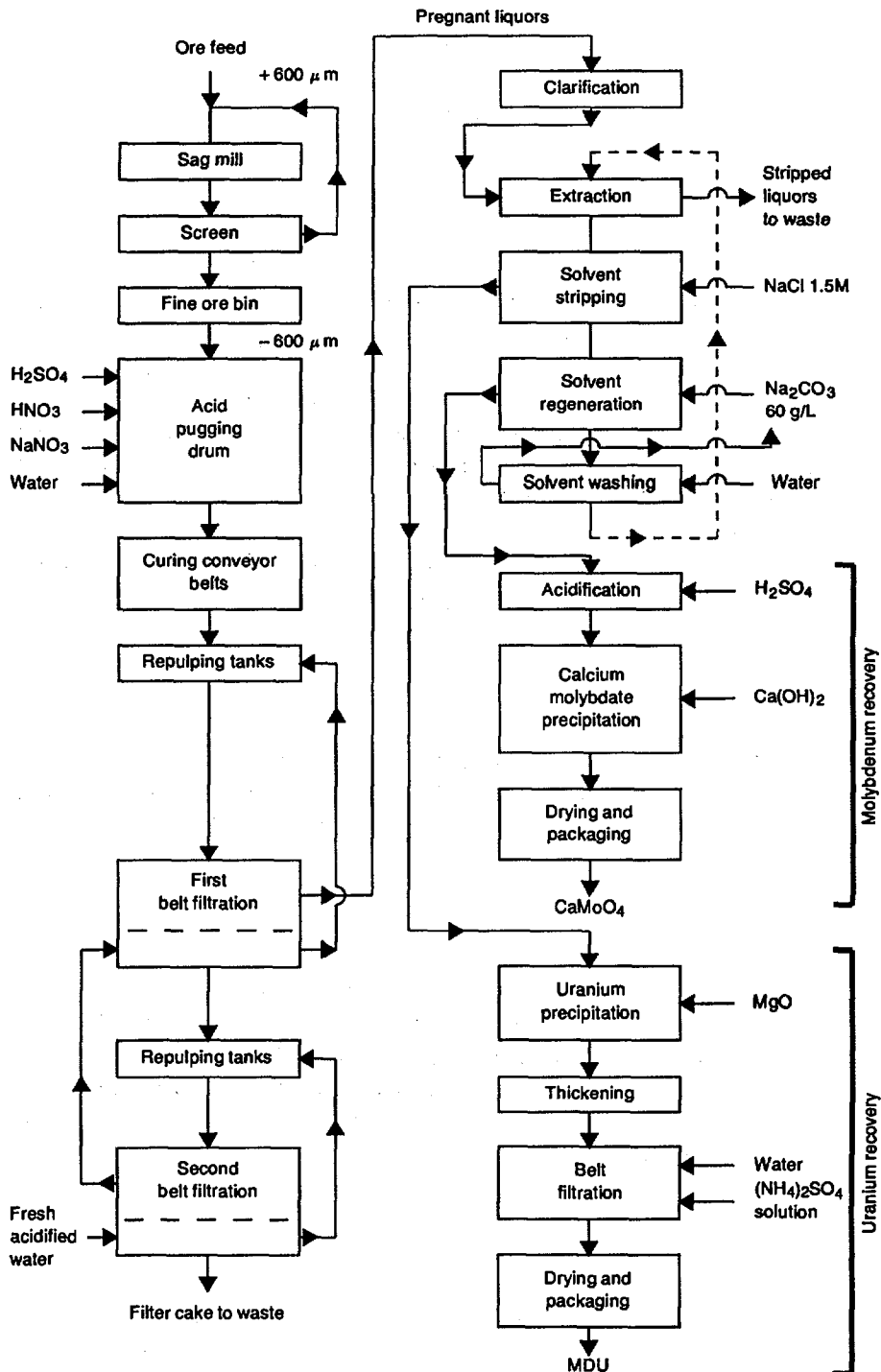

FIG. 16.1. Schematic flow sheet of process at Cominak (broken line shows a side flow).

### 16.4.1. Mining

The ore is mined by room and pillar methods. The pillars are recovered by a technique based on backfilling with low cement content concrete.

### 16.4.2. Size reduction

The ore is crushed underground to  $-250$  mm, and delivered to surface stockpiles by a conveyor belt system. The ore is reclaimed by a front end loader into a bin. A conveyor belt feeds the  $19 \times 6$  ft<sup>2</sup> SAG mill where the ore is dry ground in closed circuit with Mogensen screens (two stages, three screens). The oversize returns to the SAG mill, and the undersize (95%  $< 600$   $\mu$ m) transfers to the fine ore bin.

### 16.4.3. Leaching

The ore, which is fed at a nominal rate of 100 t/h, is treated by an acid pugging process. The ground ore feeds into a revolving drum where sulphuric acid (75 to 80 kg/t), nitric acid plus a supplemental sodium nitrate oxidant (2.5 kg/t) and water (optimum total liquid, 150 L/t) are added. The NO<sub>x</sub> vapours created during this operation are collected and contacted with water, according to a RHONE POULENC process that regenerates nitric acid. This acid is recycled to the revolving drum at a rate of 10 kg/t. Approximately 80% of the total oxidant requirement is supplied by the recycled nitric acid.

The pugged ore is cured for three hours on a series of conveyor belts and then repulped with water at a solid-liquid ratio of 1:1. The repulping temperature is 60°C, and the retention time is one hour.

The above process has been applied since major circuit modifications were completed in January of 1990. Before that date the ore was first pugged with about 10 kg/t of sodium chlorate in a revolving drum, cured for 30 min, and then pugged again with 75 to 80 kg/t of sulphuric acid in a second revolving drum. This product was cured for an additional three hours. The new process, in which the acid and oxidant are mixed simultaneously, simplified the pugging step. The nitric acid recycling also produced significant reagent savings, and the corrosion problems related to the presence of chlorate and derived compounds were reduced.

### 16.4.4. Solid-liquid separation

After flocculation with a guar gum type of flocculant, the pulp is filtered and washed on two parallel 57 m<sup>2</sup> belt filters. In 1988 a second belt filter was installed behind the first set of filters to improve the washing efficiency. An intermediate repulping step was also installed. Extensive laboratory tests had shown that a

repulping step was necessary to minimize washability problems and obtain a high uranium recovery.

Fresh acidified water is added to the second filter, and the resulting filtrates are recycled to the repulping tank between the two filtrations. The first filtrates from the second filtration are used for the washing stage of the first filtration, and the resulting wash filtrates are then recycled to the repulping tanks ahead of the first filtration.

#### 16.4.5. Solvent extraction

The pregnant liquors from the filtration step are adjusted to an EMF of 700 mV with sodium chlorate to avoid the 'crud' problems that can result from the formation of molybdenum-amine complexes. The solutions are then clarified on a static bed anthracite filter before feeding the solvent extraction operation. The nominal feed rate to the solvent extraction system is 100 m<sup>3</sup>/h. The solvent consists of a 0.2M concentration of Alamine 336 dissolved in kerosine plus a 5% addition of tridecanol modifier. Five stages of conventional pump mix mixer-settlers are used for the extraction and five stages for solvent stripping. The stripping solution is a 1.5M sodium chloride solution.

The stripped solvent is regenerated with a 60 g/L Na<sub>2</sub>CO<sub>3</sub> solution in a three stage mixer-settler unit, and then given a single stage wash in water before recycling. The resulting aqueous phase is used for making sodium carbonate.

#### 16.4.6. Uranium recovery

The uranium contained in the pregnant stripping solution is precipitated with a milk of magnesia slurry at ambient temperature in four agitated tanks. The reaction time is four hours and a pH of 7 is maintained. The pulp is then fed to a thickener. The overflow is recycled to the sodium chloride stripping liquor preparation system. The underflow feeds to a belt filter where the magnesium diuranate (MDU) is separated, washed with water and finally washed with an ammonium sulphate solution. The ammonium sulphate wash reduces the sodium content of the yellow cake. The MDU filter cake is dried in a NIRO spray dryer and placed in drums for shipment. The gases from the spray dryer are treated in an electrostatic separator before being released to the atmosphere.

#### 16.4.7. Molybdenum recovery

The Cominak mill discontinued its molybdenum recovery operation in 1987 because of a significant decrease in the molybdenum content of the ore. Before this date, solutions from the sodium carbonate solvent regeneration step were acidified to a pH value of 3 with sulphuric acid to eliminate the carbon dioxide, and the

molybdenum was precipitated as calcium molybdate. The precipitation used a milk of lime slurry, and the pH value was maintained at 9.6 for one hour. After thickening and a subsequent filtration wash on a belt filter the precipitate was dried in a Louisville type steam tube rotary dryer and placed in drums for shipment.

#### **16.4.8. Tailings management**

The filter cake from the belt filter is transported by conveyor belts to a stacker that deposits the tailings in a conical heap. The liquids are pumped to basins where they evaporate naturally. To avoid any leakage, each basin is lined with an impervious membrane. The basins are situated about 2 km from the mill, in a clayey zone where the pure clays are nearly 10 m thick. These clay beds provide additional protection against any contamination of the underlying aquifer.

### **REFERENCES**

- [16.1] GABILLAT, L., MOURET, P., BOUTONNET, G., GRENIER, J., POITTE, J., Du laboratoire à la marche industrielle: l'usine chimique de la Somair au Niger, Suppl. to Rev. Ind. Miner. (Oct. 1974) 98-124.
- [16.2] LEGER, J.L., BOUTONNET, G., Arlit uranium mills use strong acid leach process, World Min. (May 1974) 40.



## Chapter 17

### WHITE MESA

#### 17.1. INTRODUCTION

The White Mesa uranium–vanadium mill came into production during the early part of 1980. It is the most recently constructed uranium mill in the USA. The mill, which is located on the Colorado Plateau six miles south of Blanding, Utah, is owned jointly by UMETCO and Energy Fuels Nuclear (70% UMETCO and 30% Energy Fuels Nuclear). The mill is licensed and operated by UMETCO.

Mill licensing was accomplished through the US Nuclear Regulatory Commission (NRC). UMETCO submitted the source material licence application, supported by the necessary baseline studies and a consultant's environmental report in February 1978. The NRC approved the licence in August 1979 — a remarkably short period, considering that a Federal Government Environmental Impact Statement had to be prepared. The licensing and permit process went smoothly except for one serious and costly impediment. The mill was sited in the middle of an extensive archaeological district; therefore, US federal rules regarding archaeological resource protection were applied. After the appropriate surveys had been completed a memorandum of agreement was prepared between the NRC and the Advisory Council for Historic Preservation. Fortunately, the archaeological contractors managed to complete their excavations just ahead of when the mill was scheduled to be constructed. This costly programme illustrates one of the many factors that can have a significant impact on a mill planning and construction schedule.

In recent years the mill has operated intermittently as required to fulfil contract commitments. The mill temporarily suspended operations in late 1990 for maintenance and some circuit modifications, principally in the vanadium operations.

The following mill construction and operating descriptions are adapted from an article published by C.E. Baker and D.K. Sparling in 1981 [17.1] and supplemented by contacts with UMETCO operating personnel.

#### 17.2. MINERALOGY AND GEOLOGY

The mill processes the following two types of ores:

- (a) Carnotite type sandstone ores that contain approximately 0.2%  $U_3O_8$  and 1.5–2.0%  $V_2O_5$ ,
- (b) Arizona Strip breccia pipe ores that contain 0.5–0.9%  $U_3O_8$  and essentially no vanadium.



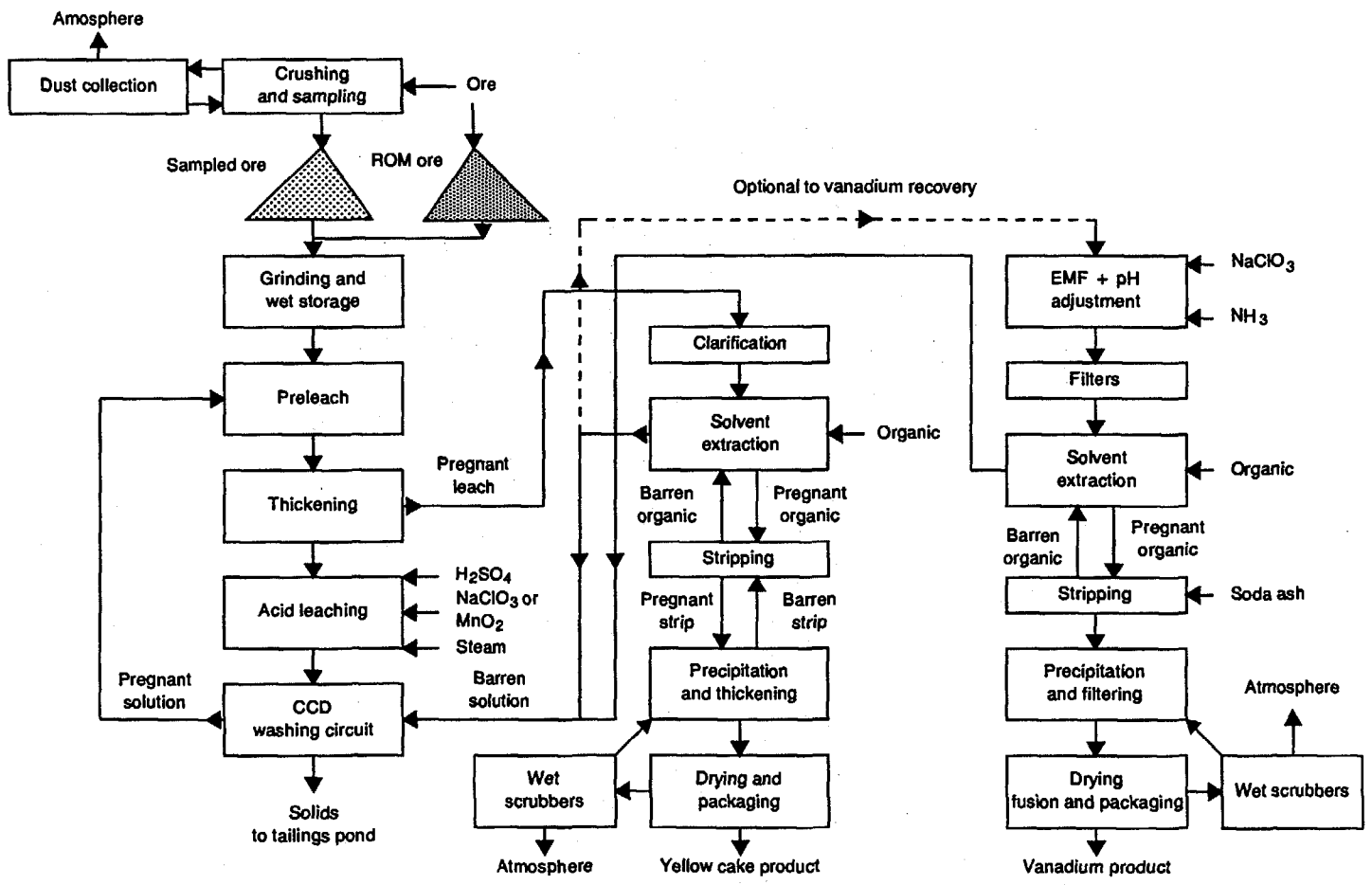

FIG. 17.1. Schematic flow sheet of process at White Mesa.

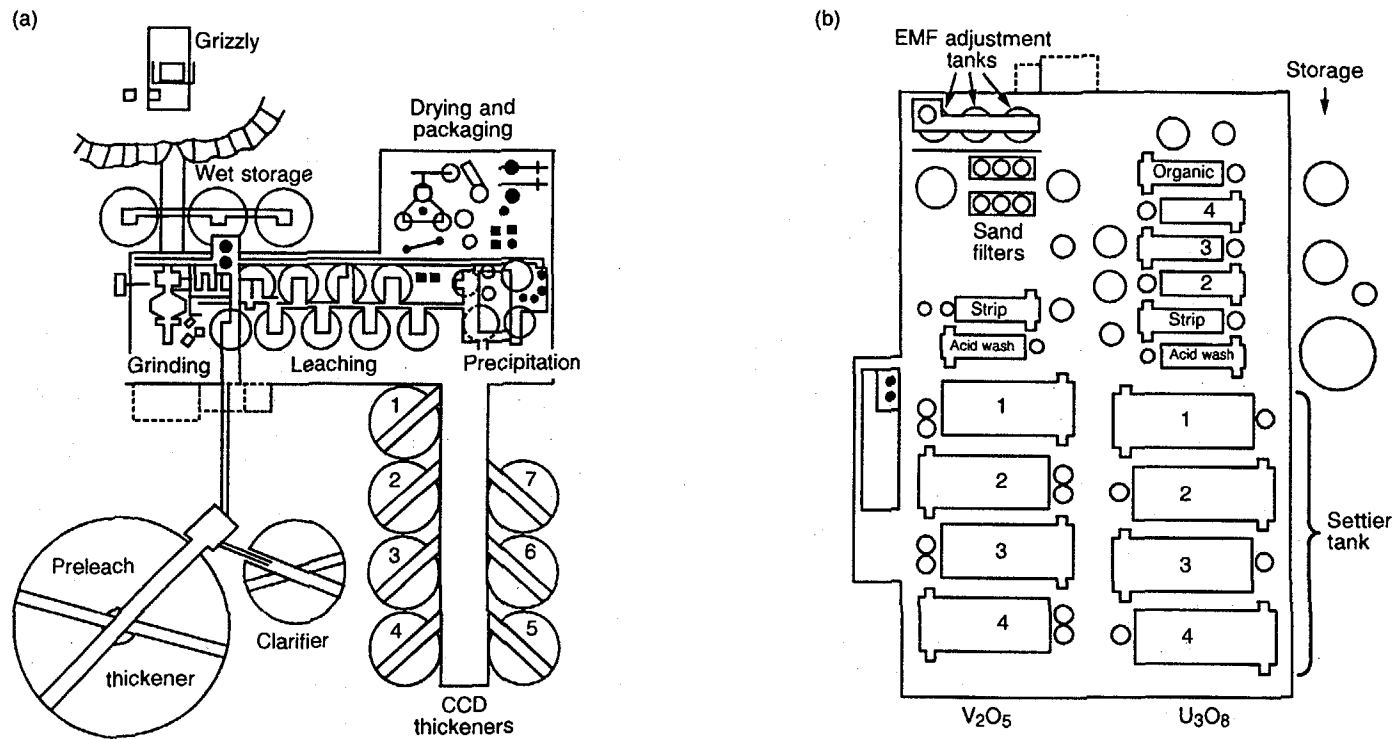

FIG. 17.2. Circuit layouts for White Mesa mill: (a) grinding, leaching and precipitation; (b) solvent extraction. Numbers indicate the flow sequence through the equipment.

The carnotite type sandstone ores are typical of those found throughout the Colorado Plateau. The mineralization is a mixture of uranium oxides and vanadium-uranium minerals.

The most important uranium minerals in the breccia pipe deposits are uranite and coffinite. Torbernite and metatorbernite are the most common secondary minerals present. The breccia matrix consists primarily of silicate minerals. Some calcite and gypsum are also present along with various sulphide minerals.

The ores are extracted separately, and the circuit operations are adjusted to the conditions required for the ore being treated. The vanadium circuit is not operated when the breccia pipe ores are being processed. The original plans also provided for appreciable purchases of custom ores, but currently nearly all of the ore being processed comes from captive mines.

### 17.3. MILL CONSTRUCTION AND OPERATION

UMETCO selected Davy McKee as the design engineer, and construction was carried out by several general contractors. The White Mesa Mill has a rated capacity of 1800 t/d of ore. The mill uses an acid leaching and solvent extraction process. The flow sheet, which is shown in Fig. 17.1, contains both uranium and vanadium circuits. Figure 17.2 shows the layout of the mill circuits.

#### 17.3.1. Grinding and leaching circuits

Ore received at White Mesa can be crushed and sampled at the buying station or fed directly to the mill. Run of mine or stockpiled ore is passed through a 0.5 m 'grizzly' into a 45 t hopper. A 1.2 m variable speed apron feeder pulls the ore from the bin and discharges it onto a  $3.4 \times 46 \text{ m}^2$  conveyor belt. The belt conveys the ore to a vibrating feeder that feeds directly into the SAG mill.

The SAG mill has a 5.5 m diameter and is 1.8 m long. The mill runs at about 13.4 rev/min and is powered by a 522 kW synchronous motor. A 7% ball charge is normally used, and the slurry density in the mill ore is maintained at about 70% solids. The mill discharges onto three  $1.2 \times 0.2 \text{ m}^2$  vibrating screens that close the grinding circuit. When run of mine ore is being fed, the grinding rate is about 136 t/h. The rate rises to nearly 154 t/h when the feed is -38 mm material that has been crushed and sampled. The SAG mill usually operates two shifts per day.

After grinding ore is stored as a wet slurry in three 10.7 m diameter by 10.4 m high mechanically agitated steel tanks. Each tank has a capacity of 900 m<sup>3</sup>, equivalent to 590 t of dry ore. The slurry densities in the holding tanks are usually maintained at about 55 to 58% solids.

The White Mesa mill uses a two stage leaching system. The first stage, which is designated as the preleaching circuit, consists of two  $6.7 \times 6.7 \text{ m}^2$  mechanically agitated wood-stave tanks. The raw ore slurry from the holding tanks is combined

here with the strong acid solution from the CCD circuit. The equivalent dry ore feed rate is about 82–91 t/h. The pulp density in the preleaching circuit is about 22% solids.

Excess acid is neutralized in the preleaching circuit by the  $\text{CaCO}_3$  content of the ore, and some leaching also occurs. The preleaching slurry discharges by gravity into a conventional 38 m diameter thickener. The underflow slurry is pumped to the second stage leaching circuit, and the overflow solution is pumped through clarification filters to the solvent extraction stage.

The second stage leaching unit uses a hot strong acid contact; this produces a product slurry with a high free acid concentration. The circuit consists of seven chlorobutyl rubber lined steel tanks. Each tank, which is 7.6 m in diameter and 8.2 m in height, is agitated by a 2.4 m diameter rubber covered axial flow propeller powered by a 56 kW electric motor. The retention time in the leaching circuit is about 24 h.

The controllers maintain the temperature in the first two tanks of the strong acid leaching circuit close to  $75^\circ\text{C}$ , and the free acid is held at about 70 g/L. The pulp density is in the 52–54% solids range. The EMF is held at close to  $-430$  mV by adding sodium chlorate if needed. The leaching normally produces uranium recoveries close to 95%, and the vanadium recovery is about 75%.

### 17.3.2. CCD washing circuit

The CCD washing circuit uses seven high capacity thickeners. Each unit is 12 m in diameter and 3 m in height. A ratio of 2.5 t of wash water per tonne of dry solids is used. The densities on the thickener underflows are controlled at about 50% solids.

The flocculant additions are controlled automatically to achieve the optimum underflow densities. The float devices measure the thickener solid–liquid interfaces and actuate diaphragm valves that control the underflow pumping rates. The underflow densities, flow rates, slime levels and thickener torque measurements are all shown continuously on the operator's control panel readout screens.

### 17.3.3. Uranium solvent extraction and precipitation

The uranium solvent extraction circuit consists of:

- (a) Four extraction stages,
- (b) One organic washing stage,
- (c) Four stripping stages,
- (d) One organic regeneration stage.

An organic recycling of 1.1 organic phase to 1.0 aqueous maintains organic phase continuity in the mixers.

The solvent mixture is 2.5% amine, 2.5% isodecanol and 95% kerosine. Organic losses in the uranium circuit are approximately 0.4 L per 3.8 m<sup>2</sup> of aqueous phase. The settlers produce excellent phase separation. Raffinates average less than 0.001 g/L U<sub>3</sub>O<sub>8</sub>. As shown in Fig. 17.1, the barren raffinate is recycled to the washing circuit. There is essentially no circuit bleed except through the thickener underflow from the CCD washing circuit. This means that the dissolved solids content of the solvent extraction feed solutions must be continuously monitored. The system is operated close to the maximum conditions that can be tolerated.

A 1.5M sodium chloride stripping solution was selected because some molybdenum is present in the ores processed in the White Mesa mill. The solvent extraction upgrading factor is approximately 30:1; this produces a stripping product liquor containing about 25 g/L U<sub>3</sub>O<sub>8</sub>.

The yellow cake circuit uses continuous precipitation with anhydrous ammonia. The precipitation is followed by two stages of thickening and washing using two solid bowl centrifuges in series. The centrifuge product is dried at 590°C in a six hearth Skinner roaster. The final product contains approximately 94% U<sub>3</sub>O<sub>8</sub>.

#### 17.3.4. Vanadium processing

When vanadium ores are being processed the uranium raffinates containing the vanadium are processed in a subsequent circuit that extracts solvent and precipitates ammonium metavanadate (AMV). First, the pH and EMF are adjusted to the desired levels in a series of three tanks, and then the adjusted solution is fed to a solvent extraction circuit. This circuit is similar to that used for the uranium extraction. However, since vanadium extraction is slower than for uranium, double mixers are installed in each of the vanadium extraction stages. The aqueous feed to the vanadium circuit normally contains 3.5–4.0 g/L of V<sub>2</sub>O<sub>5</sub>. Vanadium raffinates assay about 0.25 g/L V<sub>2</sub>O<sub>5</sub>. A 10% soda ash solution is used to strip the loaded vanadium organic. Strip product solutions normally contain about 160 g/L V<sub>2</sub>O<sub>5</sub>.

A continuous ammonium sulphate precipitation system produces high purity ammonium metavanadate (AMV). The precipitated AMV is filtered, washed and dried or alternatively deammoniated in a 3.7 m six hearth Skinner dryer at about 450°C to remove the NH<sub>3</sub> and produce an oxide product.

The dried, powdered vanadium oxide from the Skinner dryer is fused at 900°C in a 1.8 × 3.7 m<sup>2</sup> UMETCO designed fusion furnace. The molten vanadium oxide is cooled on a 2.4 m diameter casting wheel and conveyed to a holding bin. The flake product is packaged in 208 L drums for shipment.

#### 17.3.5. Mill circuit features

Baker and Sparling [17.1] have presented the following comments on the mill circuit operations:

- (a) "Semi-autogenous grinding mills are popular in the uranium milling industry because they simultaneously crush and grind, reduce dust emissions by wet grinding instead of crushing, and handle frozen ore more easily. The rotation on the White Mesa SAG mill may be reversed to extend liner and lifter life. Reversing the mill is much easier than turning lifters by hand.
- (b) "The solvent extraction circuit layout includes uranium and vanadium recovery circuits. There is an elevated central control room so the operator can observe the entire solvent extraction operation for both circuits. Malfunctions that might not appear on the operator's control panel can easily be seen from the operator's station. All solvent extraction settlers rest on the floor, eliminating the need for catwalks. Solution depths can be measured from the floor.
- (c) "Seven non-conventional high-capacity thickeners are used for recovering pregnant solutions from the leach solids. Because conditions in the small high-capacity thickeners can easily be upset, a conventional 38 m diameter thickener was installed in the pre-leach circuit between the CCD and the solvent extraction circuits.
- (d) "The mill is generally simple to operate and keep clean. Production schedules have been met when processing uranium ores, and tonnages up to 2200 t/d have been obtained. Some difficulties were experienced in starting up the vanadium circuit; but, at present, tonnages are maintained and adequate recoveries are achieved."

#### 17.4. TAILINGS MANAGEMENT

The White Mesa mill tailings management system uses a cellular, mostly subgrade, synthetic lined system. This allows for minimal disturbance and exposure at a given time and provides for incremental reclamation.

The initial planning provided for five tailings cells, each covering an area of about 0.2 km<sup>2</sup>. A sixth cell with a surface area of approximately 0.4 km<sup>2</sup> has now been added.

The area for each cell was excavated to a depth of 9 m. The cell bottoms were then cleaned and smoothed. Next, a layer of relatively impervious material was applied to serve as a bedding for the plastic liner. The first cells used a 0.762 mm thick (30 mil) PVC liner, and the most recent cell was lined with high density polyethylene.

Installation of the cell liners involved unrolling the individual plastic sheets, laying them flat, and then joining the sheets together. All the seams of the liners were repeatedly inspected before the plastic was covered with another layer of semi-impervious material.

A decanting system was installed in the sump section of each cell to transfer the pond overflow to the subsequent cell, which functions as an evaporating pond.

Waste solution management is achieved by solar evaporation; there is no off-site solution discharge.

As each tailings cell is filled, reclamation starts as soon as the material in the cell has dried sufficiently to allow movement of the equipment over the tailings. The cell is first covered with a 0.6 m thick layer of compacted clay. Then 1.2 m of on-site clay-silt material is added, followed by 1.8 m of rock. This is covered with 152 mm of topsoil to give a total thickness of about 4 m.

An extensive monitoring system surrounds the tailings impoundments to detect any seepage. The monitoring wells are regularly sampled to determine changes in the chemical or radiological compositions of the groundwater. Another series of dry wells is in place to detect seepage on a quantitative basis. If seepage should occur a pump-back system can be installed to prevent the spread of seepage to the surrounding area.

#### REFERENCE

- [17.1] BAKER, E.C., SPARLING, D.K., Design and development of the White Mesa uranium mill, Min. Eng. (Apr. 1981) 382-385.

## Chapter 18

### ROSITA (IN SITU LEACHING)

#### 18.1. INTRODUCTION

Uranium Resources Incorporated (URI) brought the Rosita in situ facility into operation during September 1990. The property, which contains over 2700 t of proven in place  $U_3O_8$  reserves, is located 60 miles west of Corpus Christi, Texas in north eastern Duval County. The deposit (formally named the Rogers Property) was discovered by the Union Carbide Corporation in the mid-1970s. In 1980 Chevron Resources Company (CRC) acquired the leases from Union Carbide. Both companies had conducted extensive exploration drilling programmes. Because the deposit is shallow (less than 76 m below the surface) CRC considered the deposit as a potential open pit operation, but it was not developed. URI acquired the project leases from the landowners in 1985, and purchased the drill data from CRC. The permit process was completed by mid-1989, and URI commenced detailed facility planning and construction. The Rosita property now encompasses more than 1200 hectares. The mine site itself, shown in Fig. 18.1, covers about 200 ha [18.1]. The estimated annual production rate is approximately 450 t equivalent  $U_3O_8$ . Total capital cost for the facility development was approximately US \$4.5 million.

#### 18.2. GEOLOGY

The Rosita area lies in the Texas Gulf Coastal Plain geological province; this plain is basically a massive accumulation of sands, silts and clays derived from a rising continental interior [18.2]. Rivers transported the components to depositional sites along the growing ancestral Texas coastline. Both the sedimentation sequence and complex deposition processes played significant roles in creating geological and hydrological environments favourable for the deposition of the South Texas uranium ore bodies. Figure 18.2 shows a stratigraphical column of the higher geological units present in the South Texas uranium district.

The Rosita uranium deposit is located in the Pliocene Goliad Formation. This formation, which reaches a thickness of 180 m in Duval County, has the largest surface exposure of any unit in the county. The Goliad consists mainly of calcareous sands interbedded with minor gravels and clays. An east-west cross-section of the ore bearing unit is shown in Fig. 18.3. This cross section includes the mining aquifer (A sand), upper and lower confining units (B clay and A clay, respectively), and the





FIG. 18.1. General layout of the Rosita mine site.

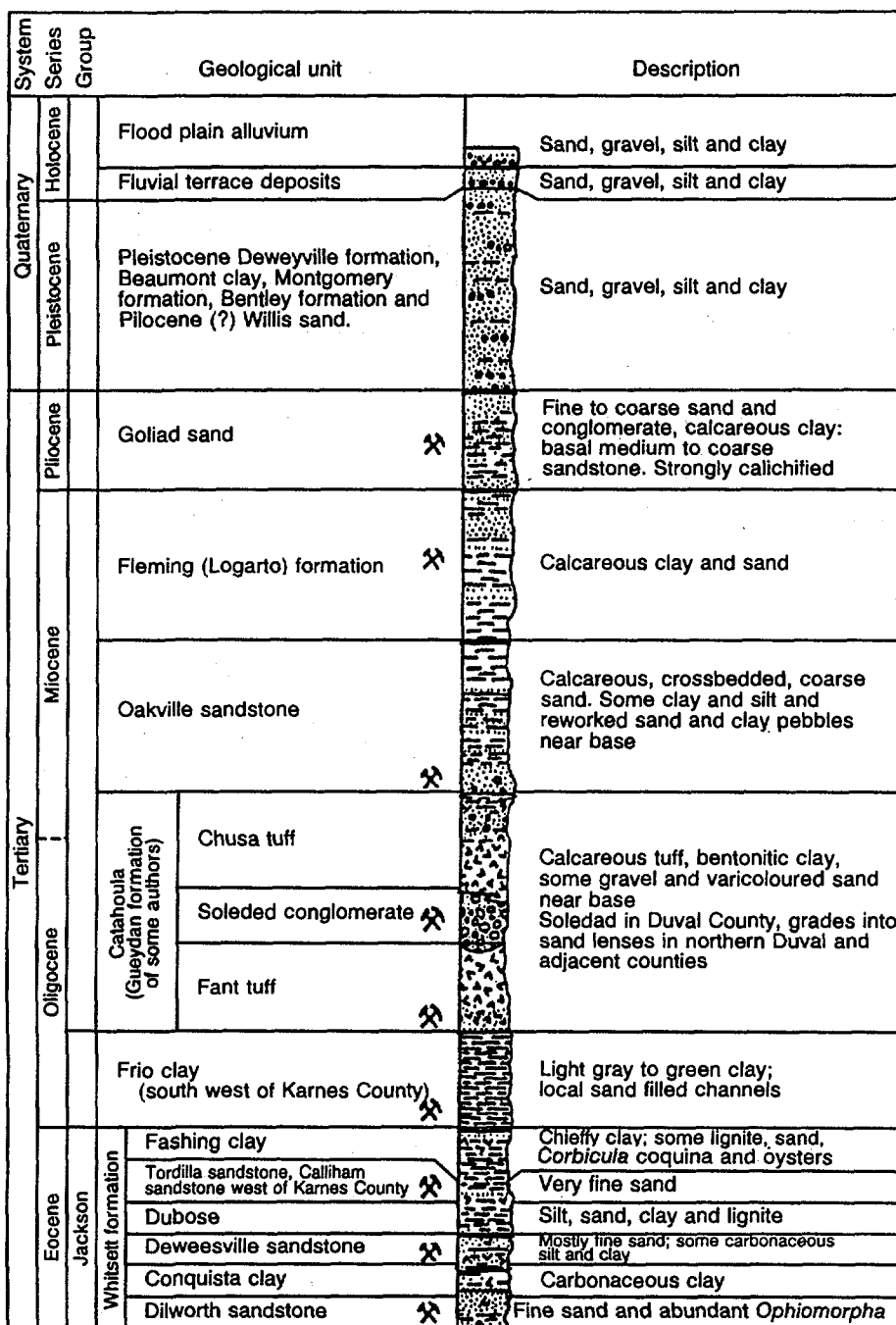

FIG. 18.2. Stratigraphic section of South Texas uranium district. Crossed picks indicate units from which uranium has been produced.

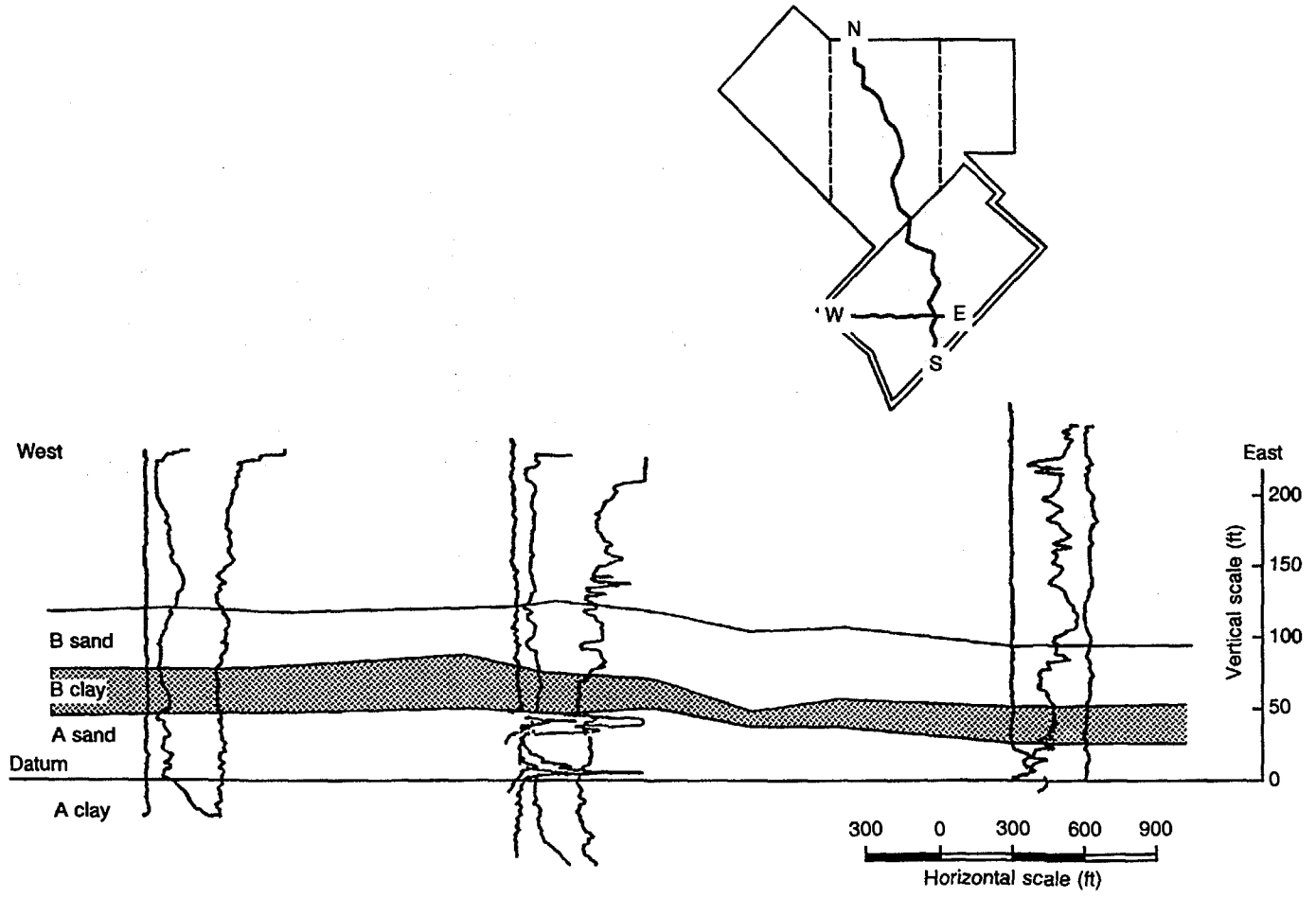

FIG. 18.3. East-west well log cross-section of Rosita site.

first overlying aquifer (B sand). The Environmental Assessment Report [18.3] describes the ore deposit geology as follows:

“The A sand, the ore-bearing unit, consists of fine to very fine-grained sandstone with interbeds of clay, siltstone, and minor conglomerate. The A sand is generally loosely consolidated, but it does contain thin well-cemented zones distributed sporadically over the proposed license area. The A sand ranges in thickness from about 3 to 17 m, with an average thickness of about 7.5 m. The production zone is found at depths of 30 to 90 m beneath the proposed license area. Uranium is present in the A sand in the minerals uraninite and/or coffinite.

“The main function of the A and B clay confining units is to ensure that mining fluids do not migrate vertically out of the production zone into the adjacent units. Desirable characteristics are fine grain size (low permeability), sufficient thickness, and continuity at least across the various mine areas. The upper confining unit, the B clay in this instance, is usually considered the more important because it seals off upper aquifers, which typically contain water of good quality. For hydrologic reasons and because aquifers below the mining zone typically contain water of lesser quality, the lower confining unit is usually considered to be less critical. Cross-sections show that the B clay ranges in thickness from 2 to 12 m. It is thicker and better developed in the north part of the Rosita site. For the most part, the B clay is distinctly finer-grained than adjacent units, but it contains some beds or lenses of sandy or silty material. Likewise, the A clay appears sandy or silty in some areas. The B sand (overlying aquifer) contains fresh-to-slightly saline water.”

### 18.3. HYDROLOGY

Table 18.1 summarizes the water bearing properties of the geological units in Duval County [18.4]. The Goliad is the most important aquifer. For example, in 1970 this aquifer supplied about 75% of all the groundwater used in Duval County.

The general groundwater flow in the county is towards the east or south east. The groundwater flow in the vicinity of the Rosita site is to the east or slightly south east at right angles to the water level contours. The normal south east flow in the Goliad has been significantly modified in some areas where large groundwater withdrawals have been made for industrial or irrigation purposes.

The hydrological evaluations conducted during the permit process showed no prohibitive porosity or permeability problems, and demonstrated that the geological conditions will allow good control of the fluid.

### 18.4. WELL FIELD DEVELOPMENTS AND RESTORATION

The development and operation of the Rosita well fields will be a sequential process [18.5]. The project will utilize six well fields, each encircled by a ring of

TABLE 18.1. AQUIFER PROPERTIES IN DUVAL COUNTY

System	Series	Geological formation	Approximate thickness (m)	Lithology	Water bearing properties
Quaternary	Holocene	Alluvium	?	Very fine to fine sand, silt and calcareous clay	Not known to yield water to wells in the county
	Holocene and Pleistocene (?)	South Texas eolian plain deposits	0-3	Fine to very fine, tan to white sand	Not known to yield water to wells in the county
	Pleistocene	Lissie formation	0-3	Variegated red to brown calcareous clayey sand, some gravel near base	Not known to yield water to wells in the county
Tertiary	Pliocene	Gollad sand	0-180	Fine to coarse, mostly gray, calcareous sand interbedded with sandstone, gravel and varicoloured calcareous clay. An abundance of caliche over most of the outcrop	Principal aquifer in the county. Yields small to large quantities of fresh to slightly saline water to public supply, industrial, irrigation, rural domestic and livestock wells
	Miocene	Fleming formation	0-300	Yellow to green calcareous or marly clay and some local seams of silty sand and lentils of coarse sand and gravel	Not known to yield water to wells in the county

TABLE 18.1. (cont.)

System	Series	Geological formation	Approximate thickness (m)	Lithology	Water bearing properties
Tertiary (cont.)	Miocene (cont.)	Oakville sandstone	0-180	Medium to fine sand, sandstone, silt, bentonitic clay and small amounts of ash	Yields small to moderate quantities of fresh to slightly saline water to industrial, rural domestic and livestock wells
		Catahoula tuff	0-430	Pink tuffaceous clay and tuff. Local lenses of sandy clay and thin to thick beds of sand and conglomerate	Yields small to moderate quantities of fresh to moderately saline water to public supply, rural domestic and livestock wells
	Oligocene (?)	Frio clay	120-180	Gypsiferous clay and thin beds of sand and silt	Not known to yield water to wells in the county
	Eocene	Jackson group	300-500	Brown to buff, sandy shale, fossiliferous sandstone and beds of volcanic ash. Does not crop out in the county	Reported to yield small quantities of moderately saline water to a few wells in the north west of the county

TABLE 18.2. WELL COMPLETION SPECIFICATION FOR THE ROSITA PROJECT

Injection/production wells	
Total depth and completion interval	Determined by geophysical logs from previous exploration holes
Type of completion	Perforated glass fibre casing (for multiple completions) or PVC screen (for single completion)
Casing	PVC
nominal size	5 in (127 mm)
ID	4.5 in (114 mm)
OD	5.05 in (128 mm)
wall thickness	0.275 in (7 mm)
joint length	20 ft (6 m)
joint type	glue
operating temperature	80°F maximum (26°C)
operating pressure	200 psi (13.6 atm)
Cement	
volume	1.1 to 1.2 times annulus volume of casing/hole
class	A
additives	4% bentonite gel
slurry weight	14.1 lb/gal (1700 g/L)
water cement ratio	7.8 gal/sack cement (0.69 L/kg)
Casing centralizers	150 ft intervals (47.5 m)
Development procedure	Air jetting and swabbing
Installation control	Pressure testing (with water) and well completion report

monitor wells (Fig. 18.1). Production will proceed sequentially from one well field to another. As production in each operating field declines, production in the next field will be initiated. The restoration of well fields will also be a sequential process. As each well field is depleted of uranium, full scale restoration will be started. The restoration procedure will use a combination of groundwater sweepage and recirculation of water treated by reverse osmosis (RO). This procedure will significantly reduce the net groundwater withdrawal. About two thirds of the water entering the RO system will be reinjected into the restoration zone. The concentrated contaminant stream from the RO operation (about one third of the RO feed) will be injected into a deep disposal well.

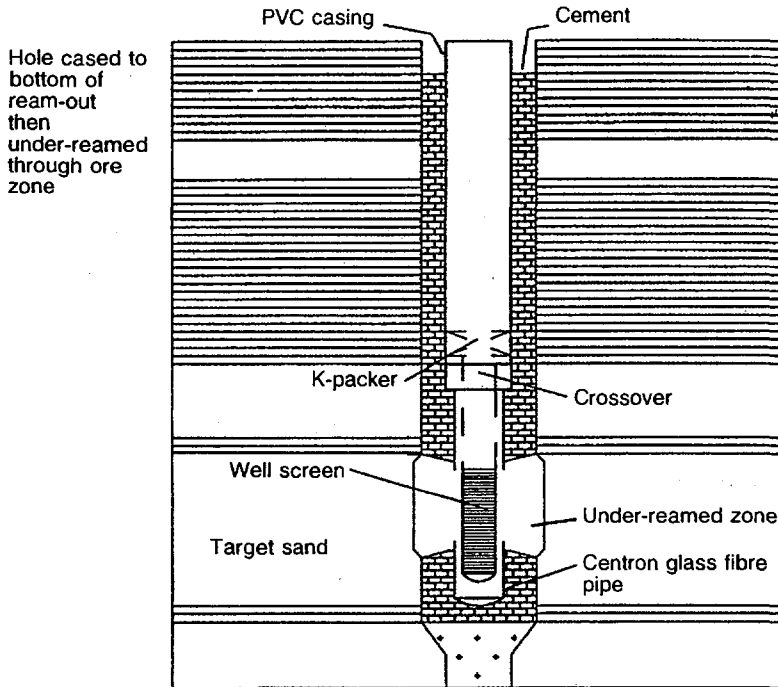

FIG. 18.4. Diagram of typical injection or production well (under-reamed production method).

The Rosita operation uses line-drive well patterns. The initial well field contains a total of 205 wells (103 production and 102 injection wells) at depths averaging 75 m. Average flow rates for the production wells over the well field life are expected to be 91 to 114 L/min.

Table 18.2 lists the completion specifications and Fig. 18.4 shows a design cross-section for a typical injection or production well.

If multiple zone completions are to be made, a casing will be installed, and under-reamed at the appropriate depths. Single zone completions will use PVC casings under-reamed and provided with PVC screens.

The anticipated period of operation for the six Rosita well fields ranges up to about eight years. This, however, could change depending on factors such as operating experience and the market conditions for uranium.



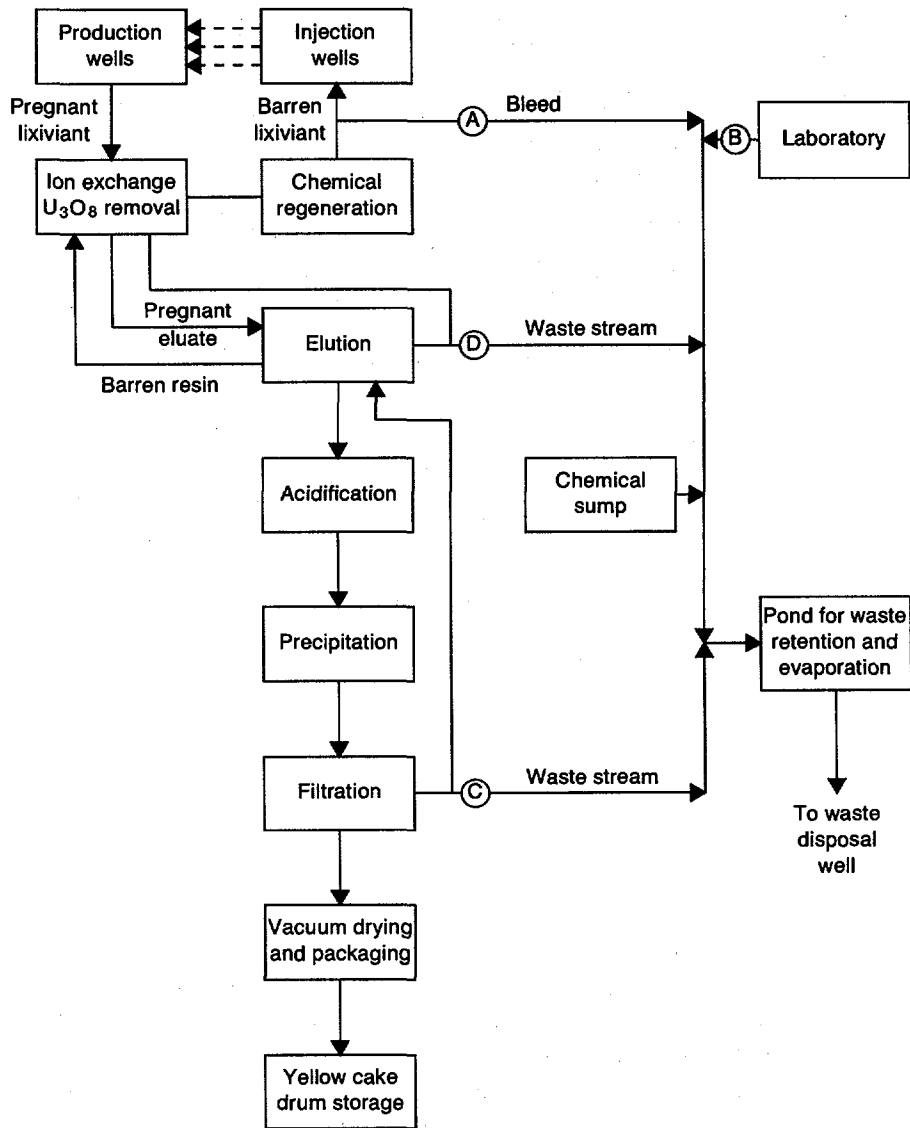

FIG. 18.5. Flow sheet for project at Rosita.

TABLE 18.3. TYPICAL COMPOSITION OF ROSITA LIXIVIANT

Component	Range of values <sup>a</sup>	
	Low	High
Calcium	15	600
Magnesium	5	100
Sodium	300	750
Potassium	8	40
Carbonate (CO <sub>3</sub> )	0	0
Bicarbonate (HCO <sub>3</sub> )	275	1000
Sulphate (SO <sub>4</sub> )	150	1000
Chloride	200	1000
Fluorine	0.5	0.5
Nitrate nitrogen (NO <sub>3</sub> as N)	0.8	0.8
Silica (SiO <sub>2</sub> )	39	40
Molybdenum	0.01	5
Uranium	0.001	400
Total dissolved solids (TDS)	1000	5000
pH	6	10

<sup>a</sup> Concentrations in mg/L and pH values in standard units.

## 18.5. WELL FIELD AND PROCESS PLANT OPERATIONS

The overall flow sheet for the Rosita well field and process plant operations is shown in Fig. 18.5 [18.6]. The basic components are typical of most US in situ mining operations. The lixiviant solution is introduced into the ore zone through injection wells. The uranium, which is present in the host ore in a reduced insoluble form, is mobilized via oxidation and the creation of a soluble complex salt. The uranium bearing leaching solution is pumped from the bottom of the production wells to the surface, where the uranium is recovered by an ion exchange process. Make-up chemicals are added to the uranium depleted ion exchange barren solution, which then recirculates to the well field.

The Rosita lixiviant solution is composed primarily of a bicarbonate ion complexing agent and dissolved oxygen gas. Table 18.3 shows the expected typical composition of the lixiviant solution.

The lixiviant circulation rate at the Rosita operation is approximately 7500 L/min. The injection pressure at the well head is maintained at no more than 9000 Pa/m of well depth. During normal operations the lixiviant injection and production rates are regulated to recover about 1% more fluid than that injected. The resulting hydraulic pressure sink causes natural groundwater from outside the ore zone to migrate into the well field. This migration prevents outward movement of the lixiviant solution and potential contamination of the aquifer zone surrounding the ore body. The 1% excess quantity of fluid forms the primary liquid waste stream from the surface process plant.

The pregnant leach liquor from the well field is pumped to the process plant through a network of well field piping, collection headers and trunk lines. It is stored in a vented surge tank. Dissolved gases including  $^{222}\text{Ra}$  are released, owing to depressurizing, and dissipated into the surrounding atmosphere.

After degassing, the pregnant leach liquor is pumped through three parallel trains of URI designed upflow ion exchange columns. The columns contain a strong base ion exchange resin, which can extract the uranium according to either of the following reactions:

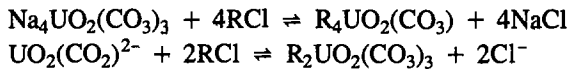

where R is the reactive site on the ion exchange resin.

The uranium depleted barren solution from the ion exchange operation passes through two surge tanks and is then pumped through sand filters to remove any particulates. After filtration, the uranium barren solution is refortified with the requisite chemicals and piped back to the well fields for reinjection.

When the ion exchange resin in the first column of the series has been loaded to the desired level, the column is taken off-line, and a column of eluted resin is placed on-line as the 'catch' column (the final column) in the loading series.

Uranium is stripped from the loaded resin with an NaCl brine eluent using a two step split elution process based on either of the following reactions:

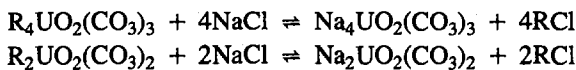

In the first elution step, partially enriched eluent (from the second elution step) is sent through the fully loaded resin bed to yield a uranium rich eluent, which is stored in the pregnant eluent tank. In the second step of the split elution technique, fresh eluent is passed through the partially eluted resin bed to remove the residual uranium. The resulting partially enriched eluent is stored in the recycling tank and used as the stripping solution for the first step of the next elution cycle.

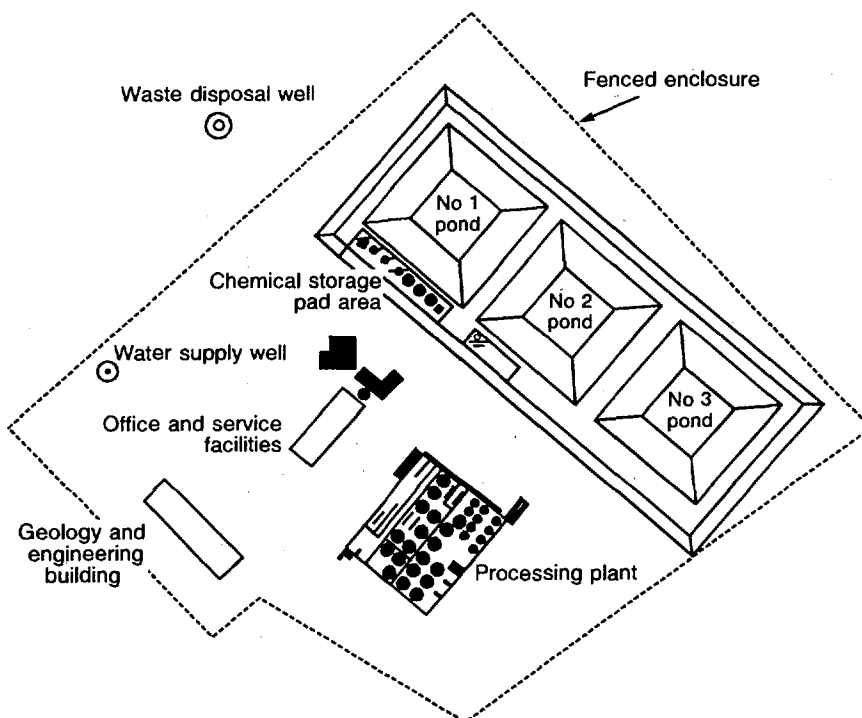

FIG. 18.6. Plan of the process area at Rosita.

The ion exchange system uses a total of eight columns. At any one time four columns are operating in the loading mode, two in the 'catch' mode, and the remaining two are in the elution mode.

The pregnant eluate is acidified with HCl to destroy the carbonate complexes, and then a yellow cake product is precipitated using a hydrogen peroxide precipitation procedure. The yellow cake product is settled and then pumped to one of two batch filter presses. After washing, the wet filter cake is loaded into tank trucks and transported to the URI in situ operation at Kingdome, where it is dried in a rotary vacuum dryer system. The dried yellow cake product is packaged in 250 L drums.

A plan of the Rosita project process area is shown in Fig. 18.6.

## 18.6. OPERATIONAL WASTE MANAGEMENT

Liquid waste streams are generated by both the normal uranium recovery operations and the restoration phases of the Rosita project. The operational waste streams are indicated by the letters A, B, C and D in Fig. 18.5. The major continuous

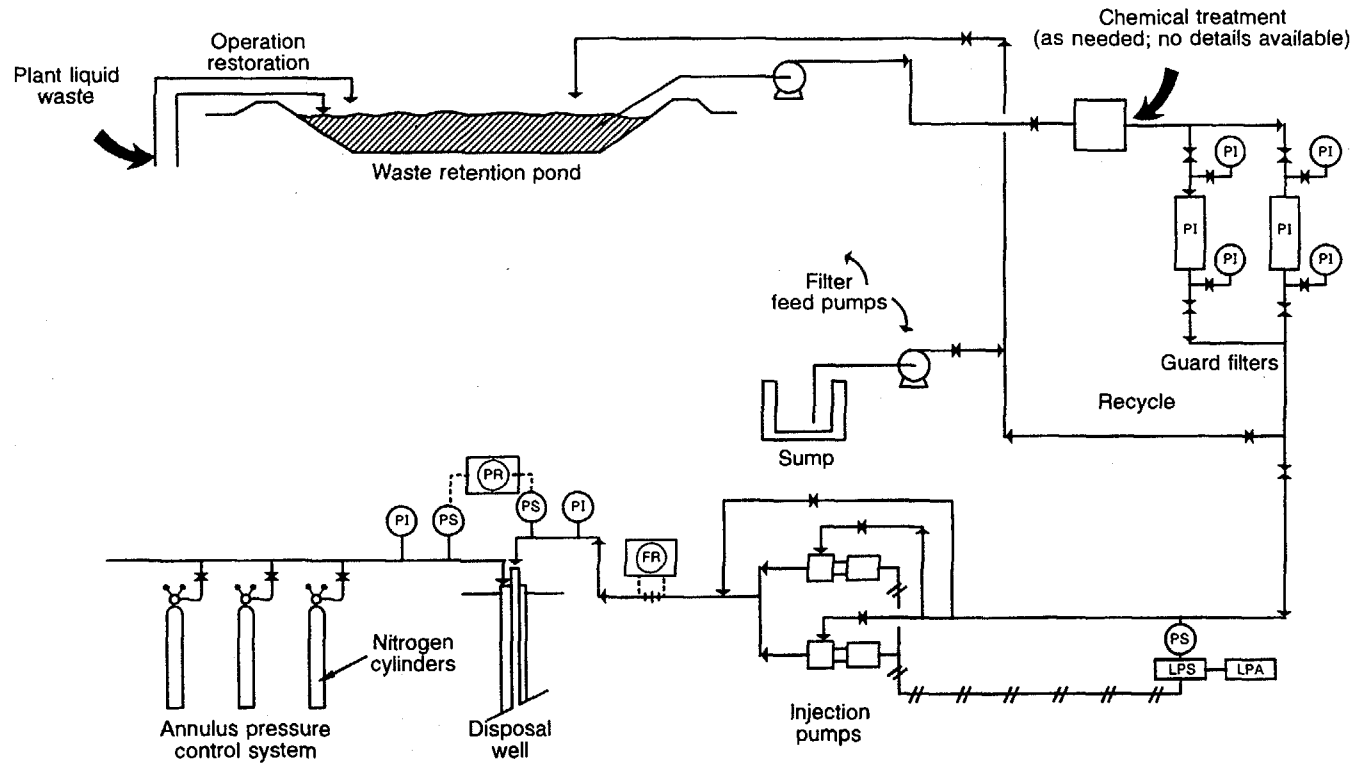

FIG. 18.7. Deep well disposal system at Rosita: FR, flow recorder; LPA, low pressure alarm; LPS, low pressure switch; PI, pressure indicator; PR, pressure recorder; PS, pressure sensor.

stream of project waste is the process bleed stream A, amounting to about 20 g/min. The discontinuous liquid waste streams produced at the process plant include the laboratory wastes (stream B), the resin wash water bleed (stream D) and the yellow cake filtrate bleed (stream C). These waste streams plus the reverse osmosis waste stream from the restoration process are collected in a lined waste retention pond.

The Rosita operation uses deep well disposal of the liquid wastes. A flow sheet for the deep well disposal system is shown in Fig. 18.7. Injection will be into the Yegua Formation in the approximate depth interval between 1340 and 1675 m. Pre-startup evaluations have demonstrated that the proposed disposal zone has sufficient porosity, permeability and thickness to accept the projected waste volume safely. The impermeable strata above the disposal zone will effectively separate the injected wastes from the overlying aquifers containing potentially usable water.

Additional details about the waste disposal system are presented in the Environmental Assessment documents [18.7].

## REFERENCES

- [18.1] TEXAS DEPARTMENT OF HEALTH — BUREAU OF RADIATION CONTROL, Environmental Assessment, Safety Evaluation Report, and Proposed License Conditions Related to the Uranium Resources Inc. Rosita Project, Duval County Texas, Rep. No. TBRC EA-17, Texas Department of Health, Austin, TX (1987) 3.
- [18.2] Ibid., 20-28.
- [18.3] Ibid., 28-29.
- [18.4] Ibid., 32-36.
- [18.5] Ibid., 81-85.
- [18.6] Ibid., 85-97, 101.
- [18.7] Ibid. 97-106.



## CONTRIBUTORS TO DRAFTING AND REVIEW

### *Consultants Group*

Ring, R.J.	Chapter 4, Section 4.3
Australian Nuclear Science and Technology	Chapter 5, Sections 5.1–5.6 Chapter 11
Ritcey, G.M.	Chapter 3
Gordon M. Ritcey & Associates	Chapter 7, Sections 7.1 and 7.3 Chapter 10 Chapter 13
Roche, M.	Chapter 2
Cogéma, France	Chapter 6, Section 6.2.2 Chapter 7, Section 7.4 Chapter 9 Chapter 12 Chapter 14 Chapter 16
Ajuria, S.	Chapter 8
Instituto Nacional de Investigaciones Nucleares, Mexico	Chapter 15
Seidel, D.C.	Introduction
International Atomic Energy Agency	Chapter 4, Sections 4.2 and 4.4 Chapter 5, Sections 5.8 and 5.9 Chapter 6, Sections 6.1 and 6.2 Chapter 7, Section 7.2 Chapter 17 Chapter 18

### *Other Contributors*

Hester, K.D.	Chapter 6, Section 6.2.1.1 and 6.3.1.1
Lyaudet, G.	Chapter 7, Section 7.4
Mueller-Kahle, E.	Chapter 1
International Atomic Energy Agency	



Gao, Xifeng Hengyang Uranium Processing Mill, China	Chapter 7, Section 7.2.3.4(c) Chapter 9, Section 9.3
Zhong, You-Ru Nie Kuo Lin Beijing Research Institute of Uranium Ore Processing, China	Chapter 7, Section 7.3.8
Xia, De-Chang; Nie, Kuo Lin Beijing Research Institute of Uranium Ore Processing, China	Section 8.3.5
Fan, Jia-Jun; Kuo Lin Beijing Research Institute of Uranium Ore Processing, China	Chapter 9, Section 9.7

# HOW TO ORDER IAEA PUBLICATIONS

☆☆ In the United States of America and Canada, the exclusive sales agent for IAEA publications, to whom all orders and inquiries should be addressed, is:

UNIPUB, 4611-F Assembly Drive, Lanham, MD 20706-4391, USA

☆☆ In the following countries IAEA publications may be purchased from the sources listed below, or from major local booksellers. Payment may be made in local currency or with UNESCO coupons.

<b>ARGENTINA</b>	Comisión Nacional de Energía Atómica, Avenida del Libertador 8250, RA-1429 Buenos Aires
<b>AUSTRALIA</b>	Hunter Publications, 58A Gipps Street, Collingwood, Victoria 3066
<b>BELGIUM</b>	Service Courrier UNESCO, 202, Avenue du Roi, B-1060 Brussels
<b>CHILE</b>	Comisión Chilena de Energía Nuclear, Venta de Publicaciones, Amunategui 95, Casilla 188-D, Santiago
<b>CHINA</b>	IAEA Publications in Chinese: China Nuclear Energy Industry Corporation, Translation Section, P.O. Box 2103, Beijing IAEA Publications other than in Chinese: China National Publications Import & Export Corporation, Deutsche Abteilung, P.O. Box 88, Beijing
<b>FRANCE</b>	Office International de Documentation et Librairie, 48, rue Gay-Lussac, F-75240 Paris Cedex 05
<b>GERMANY</b>	UNO-Verlag, Vertriebs- und Verlags GmbH, Dag Hammarskjöld-Haus, Poppelsdorfer Allee 55, D-53115 Bonn
<b>HUNGARY</b>	Librotade Ltd., Book Import, P.O. Box 126, H-1656 Budapest
<b>INDIA</b>	Oxford Book and Stationery Co., Scindia House, New Delhi-110 001
<b>ISRAEL</b>	YOZMOT Literature Ltd., P.O. Box 56055, IL-61560 Tel Aviv
<b>ITALY</b>	Libreria Scientifica Dott. Lucio di Biasio "AEIOU", Via Coronelli 6, I-20146 Milan
<b>JAPAN</b>	Maruzen Company, Ltd, P.O. Box 5050, 100-31 Tokyo International
<b>NETHERLANDS</b>	Martinus Nijhoff International, P.O. Box 269, NL-2501 AX The Hague Swets and Zeitlinger b.v., P.O. Box 830, NL-2610 SZ Lisse
<b>PAKISTAN</b>	Mirza Book Agency, 65, Shahrah Quaid-e-Azam, P.O. Box 729, Lahore 3
<b>POLAND</b>	Ars Polona, Foreign Trade Enterprise, Krakowskie Przedmieście 7, PL-00-068 Warsaw
<b>ROMANIA</b>	Ilexim, P.O. Box 136-137, Bucharest
<b>RUSSIAN FEDERATION</b>	Mezhdunarodnaya Kniga, Sovinkniga-EA, Dimitrova 39, SU-113 095 Moscow
<b>SLOVAK REPUBLIC</b>	Alfa Publishers, Hurbanovo námestie 3, SQ-815 89 Bratislava
<b>SOUTH AFRICA</b>	Van Schaik Bookstore (Pty) Ltd, P.O. Box 724, Pretoria 0001
<b>SPAIN</b>	Díaz de Santos, Lagasca 95, E-28006 Madrid Díaz de Santos, Balmes 417, E-08022 Barcelona
<b>SWEDEN</b>	Fritzes Information Centre, S-106 47 Stockholm
<b>UNITED KINGDOM</b>	HMSO, Publications Centre, Agency Section, 51 Nine Elms Lane, London SW8 5DR
<b>YUGOSLAVIA</b>	Jugoslovenska Knjiga, Terazije 27, P.O. Box 36, YU-11001 Belgrade

☆☆ Orders (except for customers in Canada and the USA) and requests for information may also be addressed directly to:



Sales and Promotion Unit  
International Atomic Energy Agency  
Wagramerstrasse 5, P.O. Box 100, A-1400 Vienna, Austria





ISBN 92-0-103593-4  
ISSN 0074-1914